

## **Oracle® Fusion Middleware**

User's Guide for Oracle Business Rules

11g Release 1 (11.1.1.9)

**E10228-13**

February 2015

Documentation for developers and business users that provides information about using and developing applications involving facts, rules, and decision tables for Oracle Business Rules by using design-time tools, such as Oracle JDeveloper with Oracle SOA extension, and a runtime application such as Oracle SOA Composer.

Copyright © 2005, 2015 Oracle and/or its affiliates. All rights reserved.

Primary Author: Oracle Corporation

This software and related documentation are provided under a license agreement containing restrictions on use and disclosure and are protected by intellectual property laws. Except as expressly permitted in your license agreement or allowed by law, you may not use, copy, reproduce, translate, broadcast, modify, license, transmit, distribute, exhibit, perform, publish, or display any part, in any form, or by any means. Reverse engineering, disassembly, or decompilation of this software, unless required by law for interoperability, is prohibited.

The information contained herein is subject to change without notice and is not warranted to be error-free. If you find any errors, please report them to us in writing.

If this is software or related documentation that is delivered to the U.S. Government or anyone licensing it on behalf of the U.S. Government, then the following notice is applicable:

U.S. GOVERNMENT END USERS: Oracle programs, including any operating system, integrated software, any programs installed on the hardware, and/or documentation, delivered to U.S. Government end users are "commercial computer software" pursuant to the applicable Federal Acquisition Regulation and agency-specific supplemental regulations. As such, use, duplication, disclosure, modification, and adaptation of the programs, including any operating system, integrated software, any programs installed on the hardware, and/or documentation, shall be subject to license terms and license restrictions applicable to the programs. No other rights are granted to the U.S. Government.

This software or hardware is developed for general use in a variety of information management applications. It is not developed or intended for use in any inherently dangerous applications, including applications that may create a risk of personal injury. If you use this software or hardware in dangerous applications, then you shall be responsible to take all appropriate fail-safe, backup, redundancy, and other measures to ensure its safe use. Oracle Corporation and its affiliates disclaim any liability for any damages caused by use of this software or hardware in dangerous applications.

Oracle and Java are registered trademarks of Oracle and/or its affiliates. Other names may be trademarks of their respective owners.

Intel and Intel Xeon are trademarks or registered trademarks of Intel Corporation. All SPARC trademarks are used under license and are trademarks or registered trademarks of SPARC International, Inc. AMD, Opteron, the AMD logo, and the AMD Opteron logo are trademarks or registered trademarks of Advanced Micro Devices. UNIX is a registered trademark of The Open Group.

This software or hardware and documentation may provide access to or information about content, products, and services from third parties. Oracle Corporation and its affiliates are not responsible for and expressly disclaim all warranties of any kind with respect to third-party content, products, and services unless otherwise set forth in an applicable agreement between you and Oracle. Oracle Corporation and its affiliates will not be responsible for any loss, costs, or damages incurred due to your access to or use of third-party content, products, or services, except as set forth in an applicable agreement between you and Oracle.

---

---

# Contents

<b>Preface</b> .....	xiii
Audience.....	xiii
Documentation Accessibility .....	xiii
Related Documentation.....	xiii
Conventions .....	xiv
<b>What's New in This Guide for Release 11.1.1.9</b> .....	xv
<b>1 Overview of Oracle Business Rules</b>	
1.1 What are Business Rules? .....	1-1
1.1.1 What Are Rule Conditions? .....	1-3
1.1.2 What Are Rule Actions?.....	1-3
1.1.3 What Are Decision Tables? .....	1-4
1.1.4 What Are Facts and Bucketsets?.....	1-4
1.1.5 What Are Rulesets? .....	1-4
1.1.6 What Are Decision Functions?.....	1-4
1.1.7 What Are Decision Points?.....	1-4
1.1.8 What Are Dictionaries? .....	1-5
1.2 Oracle Business Rules Runtime and Design Time Elements.....	1-5
1.2.1 Decision Component (Business Rules) in a SOA Composite Application.....	1-5
1.2.2 Using Rules Engine with Oracle Business Rules in a Java EE Application.....	1-6
1.2.3 Oracle Business Rules RL Language.....	1-6
1.2.4 Oracle Business Rules SDK .....	1-6
1.2.5 Rules Designer .....	1-7
1.2.6 Oracle SOA Composer Application .....	1-7
1.3 Oracle Business Rules Engine Architecture .....	1-8
1.3.1 Declarative Rules .....	1-8
1.3.2 The RETE Algorithm .....	1-9
1.3.3 What Is Working Memory? .....	1-9
1.3.4 Rule Firing and Rule Sessions.....	1-9
<b>2 Working with Data Model Elements</b>	
2.1 Introduction to Working with Data Model Elements.....	2-1
2.2 Working with a Dictionary and Dictionary Links .....	2-1
2.2.1 Introduction to Dictionaries and Dictionary Links.....	2-2

2.2.2	How to Create a Dictionary in the SOA Tier Using Rules Designer.....	2-2
2.2.3	How to Create a Dictionary in the Business Tier Using Rules Designer.....	2-6
2.2.4	How to View and Edit Dictionary Settings.....	2-6
2.2.5	How to Link to a Dictionary .....	2-6
2.2.6	How to Update a Linked Dictionary .....	2-8
2.2.7	What You Need to Know About Dictionary Linking.....	2-8
2.2.8	What You Need to Know About Dictionary Linking and Dictionary Copies.....	2-9
2.2.9	What You Need to Know About Dictionary Linking to a Deployed Dictionary .....	2-9
2.2.10	What You Need to Know About Business Rules Inputs and Outputs with BPEL ....	2-9
2.3	Working with Oracle Business Rules Globals .....	2-10
2.3.1	How to Add Oracle Business Rules Globals.....	2-10
2.3.2	How to Edit Oracle Business Rules Globals .....	2-11
2.3.3	What You Need to Know About the Final and Constant Options.....	2-11
2.4	Working with Decision Functions .....	2-12
2.5	Working with Oracle Business Rules Functions .....	2-12
2.5.1	Introduction to Oracle Business Rules Functions .....	2-12
2.5.2	How to Add an Oracle Business Rules Function .....	2-13
2.6	Localizing Oracle Business Rule Resources .....	2-14
2.6.1	How to Localize the Resources in Oracle Business Rules.....	2-14

### 3 Working with Facts and Bucketsets

3.1	Introduction to Working with Facts and Bucketsets .....	3-1
3.2	Working with XML Facts.....	3-2
3.2.1	How to Import XML Schema and Add XML Facts .....	3-3
3.2.2	How to Display and Edit XML Facts .....	3-5
3.2.3	How to Reload XML Facts with Updated Schema .....	3-7
3.2.4	What You Need to Know About XML Facts .....	3-7
3.3	Working with Java Facts .....	3-8
3.3.1	How to Import Java Classes and Define Java Facts.....	3-8
3.3.2	How to Display and Edit Java Facts .....	3-10
3.3.3	What You Need to Know About Java Facts.....	3-11
3.4	Working with RL Facts.....	3-12
3.4.1	How to Define RL Facts .....	3-13
3.4.2	How to Display and Edit RL Facts and Add RL Fact Properties.....	3-13
3.4.3	What You Need to Know About RL Facts .....	3-14
3.5	Working with ADF Business Components Facts .....	3-15
3.5.1	How to Import and Define ADF Business Components Facts.....	3-16
3.5.2	What You Need to Know About ADF Business Components Fact Classpaths .....	3-17
3.5.3	What You Need to Know About ADF Business Components Circular References .....	3-18
3.5.4	What You Need to Know About ADF Business Components Facts.....	3-18
3.6	Working with Bucketsets.....	3-18
3.6.1	How to Define a List of Values Global Bucketset .....	3-19
3.6.2	How to Define a List of Ranges Global Bucketset .....	3-21
3.6.3	How to Define an Enumerated Type (Enum) Bucketset from XML Types .....	3-23
3.6.4	How to Define an Enumerated Type (Enum) Bucketset from Java Types.....	3-25
3.6.5	What You Need to Know About List of Values Bucketsets .....	3-27
3.6.6	What You Need to Know About Range Bucketsets .....	3-28

3.6.7	What You Need to Know About Bucketset Allowed in Actions Option .....	3-29
3.6.8	What You Need to Know About Bucket Values .....	3-29
3.7	Associating a Bucketset with Business Terms .....	3-30
3.7.1	How to Associate a Bucketset with a Fact Property .....	3-30
3.7.2	How to Associate a Bucketset with Functions or Function Arguments .....	3-31
3.7.3	How to Associate a Bucketset with a Global Value .....	3-32

## 4 Working with Rulesets and Rules

4.1	Introduction to Working with Rulesets and Rules .....	4-1
4.2	Working with Rulesets .....	4-2
4.2.1	How to Create a Ruleset .....	4-2
4.2.2	How to Set the Effective Date for a Ruleset .....	4-2
4.2.3	How to Use a Filter to Display Matching Rules in a Ruleset .....	4-3
4.2.4	Using Auto Complete when Selecting Component Values from a List .....	4-7
4.3	Working with Rules .....	4-8
4.3.1	How to Add Rules .....	4-8
4.3.2	How to Define a Test in a Rule .....	4-9
4.3.3	What You Need to Know About Oracle Business Rules Test Variables .....	4-12
4.3.4	How to Define Range Tests in Rules .....	4-13
4.3.5	How to Define Set Tests in Rules .....	4-16
4.3.6	How to Define Actions in Rules .....	4-19
4.3.7	What You Need to Know About Rule Actions .....	4-21
4.3.8	What You Need to Know About Oracle Business Rules Performance Tuning .....	4-22
4.4	Validating Dictionaries .....	4-22
4.4.1	Understanding Data Model Validation .....	4-23
4.4.2	Understanding Rule Validation .....	4-23
4.4.3	Understanding Decision Table Validation .....	4-24
4.4.4	How to Validate a Dictionary .....	4-25
4.5	Using Advanced Settings with Rules and Decision Tables .....	4-25
4.5.1	How to Show and Hide Advanced Settings in a Rule or Decision Table .....	4-26
4.5.2	How to Select the Advanced Mode Option .....	4-27
4.5.3	How to Select the Active Option .....	4-28
4.5.4	How to Select the Logical Option .....	4-28
4.5.5	How to Set a Priority for a Rule .....	4-29
4.5.6	How to Specify Effective Dates .....	4-30
4.6	Working with Nested Tests .....	4-30
4.6.1	How to Use Nested Tests .....	4-30
4.7	Working with Advanced Mode Rules .....	4-31
4.7.1	How to Use Advanced Mode Pattern Matching Options .....	4-32
4.7.2	How to Use Advanced Mode Matched Fact Naming .....	4-34
4.7.3	How to Use Advanced Mode Action Forms .....	4-37
4.7.4	How to Use Advanced Mode Aggregate Conditions .....	4-38
4.7.5	What You Need to Know About Advanced Mode Rules .....	4-42
4.8	Working with Tree Mode Rules .....	4-43
4.8.1	Introduction to Tree Mode Rules .....	4-43
4.8.2	How to Create Simple Tree Mode Rules .....	4-48
4.8.3	How to Create Advanced Tree Mode Rules .....	4-54

4.8.4	What You Need to Know About Tree Mode Rules .....	4-55
4.9	Using Date Facts, Date Functions, and Specifying Effective Dates .....	4-56
4.9.1	How to Use the Current Date Fact .....	4-56
4.9.2	How to Set the Effective Date for a Rule .....	4-57
4.9.3	What You Need to Know About Effective Dates .....	4-58
4.9.4	How to Use Duration, JavaDate, OracleDate, and XMLDate Methods.....	4-59
4.10	Working with Expression Builder .....	4-60
4.10.1	Introduction to the Expression Builder .....	4-60
4.10.2	How to Use the Expression Builder .....	4-61
4.10.3	What You Need to Know About Working with Expressions .....	4-61
4.11	Using Bucketsets as Constraints for Options Values in Rules .....	4-62
4.11.1	How to Use a List of Ranges Bucketset as a Constraint for a Business Term .....	4-62
4.11.2	How to Use a List of Values Bucketset as a Constraint for a Fact Property.....	4-64
4.11.3	How to Use Bucketsets to Provide Options for Test Expressions .....	4-64
4.12	Importing Runtime Rules Changes From Repository Into JDeveloper .....	4-65

## 5 Working with Decision Tables

5.1	Introduction to Working with Decision Tables .....	5-1
5.1.1	What is a Decision Table? .....	5-2
5.1.2	Understanding Decision Table Values .....	5-7
5.1.3	What You Need to Know About Decision Table Loops .....	5-8
5.2	Creating Decision Tables .....	5-8
5.2.1	How to Create a Decision Table .....	5-8
5.2.2	How to Add Condition Rows to a Decision Table.....	5-9
5.2.3	How to Add Actions to a Decision Table.....	5-10
5.2.4	How to Add a Rule to a Decision Table .....	5-12
5.2.5	How to Define Tests in a Decision Table.....	5-13
5.3	Performing Operations on Decision Tables .....	5-14
5.3.1	Introduction to Decision Table Operations.....	5-14
5.3.2	How to Compact or Split a Decision Table .....	5-23
5.3.3	How to Merge or Split Conditions in a Decision Table .....	5-23
5.3.4	How to Merge, Split, and Specify Do Not Care for Condition Cells .....	5-23
5.3.5	How to Perform Decision Table Gap Checking .....	5-24
5.3.6	How to Perform Decision Table Manual Conflict Resolution.....	5-24
5.3.7	How to Set the Decision Table Auto Override Conflict Resolution Policy .....	5-25
5.3.8	How to Set the Decision Table Ignore Conflicts Policy .....	5-25
5.4	Creating and Running an Oracle Business Rules Decision Table Application.....	5-25
5.4.1	How to Obtain the Source Files for the Order Approval Application.....	5-26
5.4.2	How to Create an Application for Order Approval .....	5-27
5.4.3	How to Create a Business Rule Service Component for Order Approval .....	5-28
5.4.4	How to View Data Model Elements for Order Approval.....	5-32
5.4.5	How to Add Bucketsets to the Data Model for Order Approval .....	5-33
5.4.6	How to Associate Bucketsets with Order and CreditScore Properties .....	5-35
5.4.7	How to Check the Business Rule Validation Log for Order Approval .....	5-37
5.4.8	How to Deploy the Order Approval Application.....	5-37
5.4.9	How to Test the Order Approval Application .....	5-38

## 6 Working with Decision Functions

6.1	Introduction to Decision Functions.....	6-1
6.2	Working with Decision Functions.....	6-1
6.2.1	How to Add or Edit a Decision Function.....	6-1
6.3	What You Need to Know About Decision Functions.....	6-5
6.3.1	What You May Need to Know About Rule Firing Limit Option for Debugging Rules.... 6-6	
6.3.2	What You May Need to Know to About Decision Function Arguments.....	6-6
6.3.3	What You May Need to Know About the Decision Function Stateless Option .....	6-6

## 7 Working with Rules SDK Decision Point API

7.1	Introduction to Rules SDK and the Car Rental Sample Application .....	7-1
7.1.1	Introduction to Decision Point API.....	7-1
7.1.2	How to Obtain the Car Rental Sample Application .....	7-2
7.1.3	How to Open the Car Rental Sample Application and Project.....	7-2
7.2	Creating a Dictionary for Use with a Decision Point.....	7-3
7.2.1	How to Create Data Model Elements for Use with a Decision Point.....	7-3
7.2.2	How to View a Decision Function to Call from the Decision Point .....	7-4
7.2.3	How to Create Rules or Decision Tables for the Decision Function .....	7-6
7.2.4	What You Need to Know About Using Car Rental Sample with a Decision Table... 7-8	
7.3	Creating a Java Application Using Rules SDK Decision Point .....	7-9
7.3.1	How to Add a Decision Point Using Decision Point Builder.....	7-10
7.3.2	How to Use a Decision Point with a Pre-loaded Dictionary .....	7-11
7.3.3	How to Use Executor Service to Run Threads with Decision Point.....	7-12
7.3.4	How to Create and Use Decision Point Instances.....	7-13
7.4	Running the Car Rental Sample.....	7-14
7.5	What You Need to Know About Using Decision Point in a Production Environment. 7-15	
7.6	What You Need to Know About Decision Point and Decision Tracing .....	7-16

## 8 Testing Business Rules

8.1	Testing Oracle Business Rules at Design Time.....	8-1
8.1.1	How to Test Rules Using the Rules Test Framework.....	8-1
8.1.2	What You Need to Know About Validation of Test Suites .....	8-11
8.1.3	What You Need to Know About Testing Linked Dictionaries .....	8-12
8.1.4	What You Need to Know About Failure of Test Suites .....	8-12
8.1.5	How to Test a Decision Function Using an Oracle Business Rules Function .....	8-15
8.1.6	What You Need to Know About Testing Decision Functions .....	8-17
8.2	Testing Oracle Business Rules at Runtime .....	8-18

## 9 Creating a Rule-enabled Non-SOA Java EE Application

9.1	Introduction to the Grades Sample Application .....	9-1
9.2	Creating an Application and a Project for Grades Sample Application.....	9-2
9.2.1	How to Create a Fusion Web Application for the Grades Sample Application.....	9-2
9.2.2	How to Develop Accessible ADF Faces Pages .....	9-3
9.2.3	How to Create the Grades Project .....	9-4

9.2.4	How to Add the XML Schema and Generate JAXB Classes in the Grades Project....	9-5
9.2.5	How to Create an Oracle Business Rules Dictionary in the Grades Project.....	9-6
9.3	Creating Data Model Elements and Rules for the Grades Sample Application.....	9-9
9.3.1	How to Create Bucketsets for Grades Sample Application.....	9-10
9.3.2	How to Add a Decision Table for Grades Sample Application.....	9-11
9.3.3	How to Add Actions in the Decision Table for Grades Sample Application.....	9-12
9.3.4	How to Rename the Decision Function for Grades Sample Application.....	9-14
9.4	Adding a Servlet with Rules SDK Calls for Grades Sample Application.....	9-15
9.4.1	How to Add a Servlet to the Grades Project.....	9-15
9.5	Adding an HTML Test Page for Grades Sample Application.....	9-22
9.5.1	How to Add an HTML Test Page to the Grades Project.....	9-22
9.6	Preparing the Grades Sample Application for Deployment.....	9-23
9.6.1	How to Create the WAR File for the Grades Sample Application.....	9-23
9.6.2	How to Add the Rules Library to the Grades Sample Application.....	9-26
9.6.3	How to Add the MDS Deployment File to the Grades Sample Application.....	9-27
9.6.4	How to Add the EAR File to the Grades Sample Application.....	9-31
9.7	Deploying and Running the Grades Sample Application.....	9-33
9.7.1	How to Deploy to Grades Sample Application.....	9-33
9.7.2	How to Run the Grades Sample Application.....	9-34

## 10 Working with Oracle Business Rules and ADF Business Components

10.1	Introduction to Using Business Rules with ADF Business Components.....	10-1
10.1.1	Understanding Oracle Business Rules ADF Business Components Fact Types.....	10-1
10.1.2	Understanding Oracle Business Rules Decision Point Action Type.....	10-3
10.2	Using Decision Points with ADF Business Components Facts.....	10-4
10.2.1	How to Call a Decision Point with ADF Business Components Facts.....	10-4
10.2.2	How to Call a Decision Function with Java Decision Point Interface.....	10-7
10.2.3	What You Need to Know About Decision Function Configuration with ADF Business Components 10-8	
10.3	Creating a Business Rules Application with ADF Business Components Facts.....	10-9
10.3.1	How to Create an Application That Uses ADF Business Components Facts.....	10-9
10.3.2	How to Add the Chapter10 Generic Project.....	10-9
10.3.3	How to Create ADF Business Components Application for Business Rules.....	10-10
10.3.4	How to Update View Object Tuning for Business Rules Sample Application.....	10-12
10.3.5	How to Create a Dictionary for Oracle Business Rules.....	10-12
10.3.6	How to Add Decision Point Dictionary Links.....	10-13
10.3.7	How to Import the ADF Business Components Facts.....	10-14
10.3.8	How to Add and Run the Outside Manager Ruleset.....	10-15
10.3.9	How to Add and Run the Department Manager Ruleset.....	10-25
10.3.10	How to Add and Run the Raises and Retract Employees Rulesets.....	10-31

## 11 Working with Decision Components in SOA Applications

11.1	Introduction to Decision Components.....	11-1
11.2	Working with a Decision Component.....	11-2
11.2.1	Working with Decision Component Metadata.....	11-2
11.2.2	Working with Decision Components that Expose a Decision Function.....	11-4
11.2.3	Using Stateful Interactions with a Decision Component.....	11-5



11.2.4	What You Need to Know About Stateful Interactions with Decision Components	11-5
11.3	Decision Service Architecture .....	11-5

## 12 Using Oracle SOA Composer with Oracle Business Rules

12.1	Introduction to Oracle SOA Composer .....	12-1
12.2	Using Oracle SOA Composer User Authentication.....	12-2
12.2.1	What You Need to Know About SOA Composer Access Control and User Authentication	12-3
12.3	Enabling Accessibility Features in SOA Composer .....	12-3
12.4	Opening and Viewing an Oracle Business Rules Dictionary at Runtime.....	12-4
12.4.1	Opening an Oracle Business Rules Dictionary at Runtime .....	12-4
12.4.2	What You Need to Know to Obtain the Dictionary Path from the Open Dialog....	12-7
12.4.3	How to View Globals in an Oracle Business Rules Dictionary at Runtime .....	12-7
12.4.4	How to View Bucketsets in an Oracle Business Rules Dictionary at Runtime.....	12-8
12.4.5	How to View Linked Dictionary Names at Runtime .....	12-9
12.4.6	How to View Decision Functions in Oracle Business Rules Dictionary at Runtime .....	12-9
12.4.7	How to View Rulesets in an Oracle Business Rules Dictionary at Runtime.....	12-10
12.5	Getting Started with Editing and Saving a Dictionary at Runtime .....	12-12
12.5.1	What You May Need to Know About Localized Number Formatting Support in Oracle SOA Composer	12-12
12.5.2	What You May Need to Know About Cutting/Copying and Pasting Rule Elements at Runtime	12-12
12.5.3	How to Edit Globals in an Oracle Business Rules Dictionary at Runtime .....	12-13
12.5.4	How to Edit Bucketsets in an Oracle Business Rules Dictionary at Runtime.....	12-14
12.5.5	What You Need to Know About Editing Bucketsets.....	12-16
12.5.6	How to Work With Dictionary Links in an Oracle Business Rules Dictionary at Runtime	12-16
12.5.7	How to Edit Decision Functions in an Oracle Business Rules Dictionary at Runtime.....	12-18
12.5.8	What You May Need to Know About Oracle Business Rules Dictionary Editor Declarative Component	12-21
12.5.9	What You May Need to Know About Oracle Business Rules Dictionary Editor Task Flow	12-21
12.6	Editing Rules in an Oracle Business Rules Dictionary at Runtime .....	12-21
12.6.1	How to Edit Rules in an Oracle Business Rules Dictionary at Runtime.....	12-21
12.6.2	How to Add a Rule at Runtime .....	12-22
12.6.3	How to Delete a Rule at Runtime.....	12-24
12.6.4	How to Show and Edit Advanced Settings for Rules at Runtime .....	12-24
12.6.5	How to Add Rule Conditions at Runtime .....	12-25
12.6.6	How to Delete Rule Conditions at Runtime .....	12-27
12.6.7	How to Modify Rule Conditions at Runtime .....	12-27
12.6.8	How to Add Rule Actions at Runtime.....	12-28
12.6.9	How to Delete Rule Actions at Runtime .....	12-29
12.6.10	How to Modify Rule Actions at Runtime .....	12-30
12.6.11	How to Work with Advanced Mode Rules at Runtime.....	12-31
12.6.12	How to Work with Tree Mode Rules at Runtime .....	12-35
12.6.13	What You May Need to Know About Rules Paging in Oracle SOA Composer ...	12-36

12.6.14	What You May Need to Know About Oracle Business Rules Editor Declarative Component	12-37
12.6.15	What You May Need to Know About Oracle Business Rules Dictionary Editor Declarative Component	12-37
12.6.16	What You May Need to Know About Oracle Business Rules Dictionary Editor Task Flow	12-37
12.7	Using the Oracle SOA Composer Browser Windows	12-37
12.7.1	Expression Builder	12-37
12.7.2	Condition Browser	12-38
12.7.3	Date Browser	12-39
12.7.4	Right Operand Browser	12-39
12.8	Editing Decision Tables in an Oracle Business Rules Dictionary at Runtime	12-40
12.8.1	Adding a Decision Table at Runtime	12-40
12.8.2	Adding Condition Rows to a Decision Table	12-41
12.8.3	Adding Actions to a Decision Table	12-44
12.8.4	Adding Rules to a Decision Table	12-45
12.8.5	Deleting Rules in a Decision Table	12-50
12.8.6	Defining Tests in a Decision Table	12-51
12.8.7	Splitting and Compacting a Decision Table	12-53
12.8.8	Checking for Missing Rules in a Decision Table	12-54
12.8.9	Performing Conflict Resolution in Decision Tables	12-56
12.8.10	Switching From Rows to Columns	12-57
12.8.11	Working with Advanced Mode Options in a Decision Table	12-58
12.8.12	Deleting a Decision Table at Runtime	12-59
12.8.13	What You Need to Know About Rule Test Variables	12-60
12.9	Localizing Names of Resources in Oracle Business Rules	12-60
12.9.1	How to Localize the Alias of a Oracle Business Rules Component	12-61
12.10	Committing Changes for an Oracle Business Rules Dictionary at Runtime	12-63
12.10.1	What You Need to Know About Editing With Multiple Users at Runtime	12-63
12.11	Synchronizing Rules Dictionary in Oracle JDeveloper With Runtime Dictionary Updates	12-64
12.12	Validating an Oracle Business Rules Dictionary at Runtime	12-65
12.12.1	Understanding the Validation Panel	12-66
12.12.2	Updating the Validation Panel	12-69
12.13	Obtaining Composite and Dictionary Information at Runtime	12-69
12.14	Working with Tasks at Runtime	12-70
12.14.1	How to View Task Metadata at Runtime	12-70
12.14.2	How to Configure a Task or an AMX Rule Metadata at Runtime	12-73

## **A Oracle Business Rules Files and Limitations**

A.1	Rules Designer Naming Conventions	A-1
A.1.1	Ruleset Naming	A-1
A.1.2	Dictionary Naming	A-1
A.1.3	Alias Naming	A-1
A.1.4	XML Schema Target Package Naming	A-1

## **B Oracle Business Rules Built-in Classes and Functions**

B.1	String Classes.....	B-1
B.2	List Classes.....	B-4
B.3	Numeric Classes.....	B-7
B.4	Time and Duration Classes.....	B-13
B.5	Miscellaneous Classes .....	B-30
B.6	Functions .....	B-30

## **C Oracle Business Rules Frequently Asked Questions**

C.1	Why Do Rules Not Fire When A Java Object is Asserted as a Fact and Then Changed Without Using the Modify Action? C-1	
C.2	What are the Differences Between Oracle Business Rules RL Language and Java? .....	C-2
C.3	How Does a RuleSession Handle Concurrency and Synchronization? .....	C-2
C.4	How Do I Correctly Express a Self-Join? .....	C-3
C.5	How Do I Use a Property Change Listener in Oracle Business Rules? .....	C-5
C.6	What Are the Limitations on a Decision Service with Oracle Business Rules? .....	C-6
C.7	How Do I Put Java Code in a Rule? .....	C-7
C.8	Can I Use Java Based Facts in a Decision Service with BPEL? .....	C-7
C.9	How Do I Enable Debugging in a BPEL Decision Service? .....	C-7
C.10	How Do I Support Versioning with Oracle Business Rules? .....	C-7
C.11	What is the Priority Order Using Priorities with Rules and Decision Tables? .....	C-8
C.12	Why do XML Schema with xsd:string Typed Elements Import as Type JAXBElement? .....	C-8
C.13	Why Are Changes to My Java Classes Not Reflected in the Data Model? .....	C-9
C.14	How Do I Use Rules SDK to Include a null in an Expression? .....	C-9
C.15	Is WebDAV Supported as a Repository to Store a Dictionary? .....	C-9
C.16	Using a Source Code Control System with Rules Designer .....	C-10

## **D Oracle Business Rules Troubleshooting**

D.1	Getter and Setter Methods are not Visible .....	D-1
D.2	Java Class with Only a Property Setter .....	D-1
D.3	Runtime NoClassDefFound Error .....	D-2
D.4	RL Specific Keyword Naming Conflict Errors .....	D-2
D.5	java.lang.IllegalAccessException from Business Rules Service Runtime .....	D-2
D.6	JAXB 1.0 Dictionaries and RL MultipleInheritanceException.....	D-4
D.7	Why Does XML Schema with Underscores Fail JAXB Compilation? .....	D-4
D.8	How Are Decision Service Input Output Element Types Restricted? .....	D-4
D.9	How Are Decision Service Input Output Schema Restricted? .....	D-4
D.10	How Do I Handle Java Reserved Names in an Imported Fact Type?.....	D-5

## **E Working with Oracle Business Rules and JSR-94 Execution Sets**

E.1	Introduction to Oracle Business Rules and JSR-94 Execution Sets .....	E-1
E.2	Creating JSR-94 Rule Execution Sets from Oracle Business Rules Rulesets.....	E-1
E.2.1	Creating Rule Execution Set with Oracle Business Rules RL Language Text.....	E-2
E.2.2	Creating a Rule Execution Set from Oracle RL Text Specified in a URL.....	E-3
E.2.3	Creating Rule Execution Sets with Rulesets from Multiple Sources.....	E-4

E.3	Using the JSR-94 Interface with Oracle Business Rules.....	E-4
E.3.1	Creating a Rule Execution Set with createRuleExecutionSet .....	E-5
E.3.2	Creating a Rule Session with createRuleSession.....	E-5
E.3.3	Working with JSR-94 Metadata .....	E-5
E.3.4	Using Oracle Business Rules JSR-94 Extensions .....	E-6

## **F Working with Rule Reporter**

F.1	Introduction to Working with Rule Reporter .....	F-1
F.1.1	What You Need to Know About Rule Reporter HTML Style Sheets.....	F-1
F.1.2	What You Need to Know About RuleReporter API.....	F-1
F.1.3	What You Need to Know About Rule Reporter Dependent Jar Files.....	F-2
F.2	Using Rule Reporter Command Line Interface .....	F-2
F.2.1	How to List the Contents of a Dictionary with Rule Reporter Command Line .....	F-2
F.3	Using Rule Reporter with Java.....	F-3
F.3.1	How to List the Contents of a Dictionary Using Rule Reporter with Java.....	F-3

## **Index**

---

---

# Preface

This Preface contains these topics:

- [Audience](#)
- [Documentation Accessibility](#)
- [Related Documentation](#)
- [Conventions](#)

## Audience

Oracle Fusion Middleware User's Guide for Oracle Business Rules is intended for application programmers, system administrators, and other users who perform the following tasks:

- Create Oracle Business Rules programs
- Modify or customize existing Oracle Business Rules programs
- Create Java applications using rules programs
- Add rules programs to existing Java applications

To use this document, you need a working knowledge of Java programming language fundamentals.

## Documentation Accessibility

For information about Oracle's commitment to accessibility, visit the Oracle Accessibility Program website at

<http://www.oracle.com/pls/topic/lookup?ctx=acc&id=docacc>.

### Access to Oracle Support

Oracle customers that have purchased support have access to electronic support through My Oracle Support. For information, visit

<http://www.oracle.com/pls/topic/lookup?ctx=acc&id=info> or visit

<http://www.oracle.com/pls/topic/lookup?ctx=acc&id=trs> if you are hearing impaired.

## Related Documentation

Printed documentation is available for sale in the Oracle Store at

<http://oraclestore.oracle.com/>

To download free release notes, installation documentation, white papers, or other collateral, please visit the Oracle Technology Network (OTN).

<http://www.oracle.com/technology/documentation/index.html>

## Conventions

The following text conventions are used in this document:

<b>Convention</b>	<b>Meaning</b>
<b>boldface</b>	Boldface type indicates graphical user interface elements associated with an action, or terms defined in text or the glossary.
<i>italic</i>	Italic type indicates book titles, emphasis, or placeholder variables for which you supply particular values.
monospace	Monospace type indicates commands within a paragraph, URLs, code in examples, text that appears on the screen, or text that you enter.

---

---

# What's New in This Guide for Release 11.1.1.9

The following table lists the sections that have been added or changed.

For a list of known issues (release notes), see the "Known Issues for Oracle SOA Products and Oracle AIA Foundation Pack" at

<http://www.oracle.com/technetwork/middleware/docs/soa-aiafp-knownissuesindex-364630.html>.

Sections	Changes Made
What's New in This Guide for Release 11.1.1.9.0	Chapter added to list the new or updated content for this release.
Multiple chapters	Added content for the following: Combining generic rules UI and customized task approvals UI in IF/THEN rules Add filtering support to choice lists Add/Delete Global Variables in Rules ADF component Support for customized action region for decision table Ability to import dictionary from MDS into project





---

---

# Overview of Oracle Business Rules

This chapter describes the concepts of business rules and provides an overview of the Oracle Business Rules runtime and design-time elements such as facts, bucketsets, rulesets, Decision Table, and Oracle SOA Composer. It also describes the Oracle Business Rules engine architecture.

This chapter includes the following sections:

- [Section 1.1, "What are Business Rules?"](#)
- [Section 1.2, "Oracle Business Rules Runtime and Design Time Elements"](#)
- [Section 1.3, "Oracle Business Rules Engine Architecture"](#)

For more information, see:

- *Rules Language Reference for Oracle Business Process Management*
- *Oracle Fusion Middleware Java API Reference for Oracle Business Rules*
- *Developing SOA Applications with Oracle SOA Suite*

## 1.1 What are Business Rules?

Oracle Business Rules enable dynamic decisions at runtime allowing you to automate policies, computations, and reasoning while separating rule logic from underlying application code. This allows more agile rule maintenance and empowers business analysts with the ability to modify rule logic without programmer assistance and without interrupting business processes.

**Business rules** are statements that describe business policies or describe key business decisions. For example, business rules include:

- Business policies such as spending policies and approval matrices.
- Constraints such as valid configurations or regulatory requirements.
- Computations such as discounts or premiums.
- Reasoning capabilities such as offers based on customer value.

For example, a car rental company might use the following business rule:

```
Driver Age Rule
Determine if driver is old enough to rent.

IF
  Rental_application.driver age < 21

THEN
  modify Rental_application ( status : "DECLINED" )
```

An airline might use a business rule such as the following:

```
Frequent Flyer Rule
Calculate miles status

IF
  Frequent_Flyer.total_miles > 100000

THEN
  modify Frequent_Flyer ( status : "GOLD" )
```

A financial institution could use a business rule such as:

```
Loan Income Rule
Loan minimum income

IF
  Application_loan.income < 10000

THEN
  modify Application_loan ( deny : true )
```

These examples represent individual business rules. In practice, you can use Oracle Business Rules to combine many business rules or to use more complex tests.

For the car rental example, you can name the rule the Driver Age Rule. Traditionally, business rules such as the Driver Age Rule are buried in application code and might appear in a Java application as follows:

```
public boolean checkDriverAgeRule (Driver driver) {
    boolean declineRent = false;
    int age = driver.getAge();
    if( age < 21 ) {
        declineRent = true;
    }
    return declineRent;
}
```

This code is not easy for nontechnical users to read and can be difficult to understand and modify. For example, suppose that the rental company changes its policy so that all drivers under 18 are declined using the Driver Age Rule. In many production environments the developer must modify the application, recompile, and then redeploy the application. Using Oracle Business Rules, this process can be simplified because a business rules application is built to support easily changing business rules.

Oracle Business Rules allows a business analyst to change policies that are expressed as business rules, with little or no assistance from a programmer. Applications using Oracle Business Rules support continuous change that allows the applications to adapt to new government regulations, improvements in internal company processes, or changes in relationships between customers and suppliers.

A rule follows an if-then structure and consists of the following parts:

- **IF** part: a condition or pattern match (see [Section 1.1.1, "What Are Rule Conditions?"](#)).

- **THEN** part: a list of actions (see [Section 1.1.2, "What Are Rule Actions?"](#)).

Alternatively, you can express rules in a spreadsheet-like format called a Decision Table (see [Section 1.1.3, "What Are Decision Tables?"](#)).

You write rules and Decision Tables in terms of fact types and properties. Fact types are often imported from the Java classes, XML schema, Oracle ADF Business Components view objects, or may be created in Rules Designer. Fact properties have a name, value, data type, and an optional bucketset. A bucketset splits the value space of the data type into buckets that can be used in Decision Tables, choice lists, and for design time validation (see [Section 1.1.4, "What Are Facts and Bucketsets?"](#)).

You group rules and Decision Tables in an Oracle Business Rules object called a ruleset (see [Section 1.1.5, "What Are Rulesets?"](#)).

You group one or more rulesets and their facts and bucketsets in an Oracle Business Rules object called a dictionary (see [Section 1.1.8, "What Are Dictionaries?"](#)).

For more information, see [Section 1.2, "Oracle Business Rules Runtime and Design Time Elements"](#).

### 1.1.1 What Are Rule Conditions?

The rule **IF** part is composed of conditional expressions, rule conditions, that refer to facts. For example:

```
IF Rental_application.driver age < 21
```

The conditional expression compares a business term (`Rental_application.driver age`) to the number 21 using a less than comparison.

The rule condition activates the rule whenever a combination of facts makes the conditional expression true. In some respects, the rule condition is like a query over the available facts in the Rules Engine, and for every row returned from the query the rule is activated.

For more information, see:

- [Chapter 4, "Working with Rulesets and Rules"](#)
- "Rule Conditions" in the *Rules Language Reference for Oracle Business Process Management*

### 1.1.2 What Are Rule Actions?

The rule **THEN** part contains the actions that are executed when the rule is fired. A rule is fired after it is activated and selected among the other rule activations using conflict resolution mechanisms such as priority. A rule might perform several kinds of actions. An action can add facts, modify facts, or remove facts. An action can execute a Java method or perform a function which may modify the status of facts or create facts.

Rules fire sequentially, not in parallel. Note that rule actions often change the set of rule activations and thus change the next rule to fire.

For more information, see:

- [Section 1.3.4, "Rule Firing and Rule Sessions"](#)
- [Chapter 4, "Working with Rulesets and Rules"](#)
- "Ordering Rule Firing" in the *Rules Language Reference for Oracle Business Process Management*

### 1.1.3 What Are Decision Tables?

A Decision Table is an alternative business rule format that is more compact and intuitive when many rules are needed to analyze many combinations of property values. You can use a Decision Table to create a set of rules that covers all combinations or where no two combinations conflict.

For more information, see [Chapter 5, "Working with Decision Tables"](#).

### 1.1.4 What Are Facts and Bucketsets?

In Oracle Business Rules, facts are the objects that rules reason on. Each fact is an instance of a fact type. You must import or create one or more fact types before you can create rules.

In Oracle Business Rules a fact is an asserted instance of a class. The Oracle Business Rules runtime or a developer writing in the RL Language uses the RL Language `assert` function to add an instance of a fact to the Oracle Business Rules Engine.

In Rules Designer you can define a variety of fact types based on, XML Schema, Java classes, Oracle RL definitions, and ADF Business Components view objects. In the Oracle Business Rules runtime such fact type instances are called facts.

You can create bucketsets to define a list of values or a range of values of a specified type. After you create a bucketset you can associate the bucketset with a fact property of matching type. Oracle Business Rules uses the bucketsets that you define to specify constraints on the values associated with fact properties in rules or in Decision Tables. You can also use bucketsets to specify constraints for variable initial values and function return values or function argument values.

For more information, see:

- [Section 1.3, "Oracle Business Rules Engine Architecture"](#)
- [Chapter 3, "Working with Facts and Bucketsets"](#)

### 1.1.5 What Are Rulesets?

A ruleset is an Oracle Business Rules container for rules and Decision Tables. A ruleset provides a namespace, similar to a Java package, for rules and Decision Tables. In addition you can use rulesets to partially order rule firing.

For more information, see:

- [Chapter 4, "Working with Rulesets and Rules"](#)
- "Ordering Rule Firing" in the *Rules Language Reference for Oracle Business Process Management*

### 1.1.6 What Are Decision Functions?

A decision function provides a contract for invoking rules from Java or SOA (from a SOA composite application or from a BPEL process). The contract includes input fact types, rulesets to run, and output fact types. For more information, see [Chapter 6, "Working with Decision Functions"](#).

### 1.1.7 What Are Decision Points?

Oracle Business Rules SDK (Rules SDK) provides APIs that let you write applications that access, create, modify, and execute rules in Oracle Business Rules dictionaries (and all the contents of a dictionary). The Rules SDK provides the Decision Point API to

access and run rules or Decision Tables from a Java application. For more information, see [Chapter 7, "Working with Rules SDK Decision Point APT"](#).

### 1.1.8 What Are Dictionaries?

A dictionary is an Oracle Business Rules container for facts, functions, globals, bucketsets, links, decision functions, and rulesets. A dictionary is an XML file that stores the application's rulesets and the data model. Dictionaries can link to other dictionaries. Oracle JDeveloper creates an Oracle Business Rules dictionary in a `.rules` file. You can create as many dictionaries as you need. A dictionary may contain any number of rulesets. For more information, see [Section 2.2, "Working with a Dictionary and Dictionary Links"](#).

## 1.2 Oracle Business Rules Runtime and Design Time Elements

Oracle Business Rules provides support for using business rules as a Decision component or as a library in a Java application. A Decision component is a mechanism for publishing rules and rulesets as a reusable service that can be invoked from multiple business processes. To create and use rules in the Oracle SOA Suite, or to create rules and integrate these rules into your applications, Oracle Business Rules provides the following runtime and design time elements:

- [Decision Component \(Business Rules\) in a SOA Composite Application](#)
- [Using Rules Engine with Oracle Business Rules in a Java EE Application](#)
- [Oracle Business Rules RL Language](#)
- [Oracle Business Rules SDK](#)
- [Rules Designer](#)
- [Oracle SOA Composer Application](#)

### 1.2.1 Decision Component (Business Rules) in a SOA Composite Application

Oracle SOA Suite provides support for Decision components that support Oracle Business Rules. A Decision component is a mechanism for publishing rules and rulesets as a reusable service that can be invoked from multiple business processes.

A Decision Component is a SCA component that can be used within a composite and wired to a BPEL component. Apart from that, Decision components are used for dynamic routing capability of Mediator and Advanced Routing Rules in Human Workflow.

Oracle Business Rules Rules Engine (Rules Engine) is available in a SOA composite application using the SOA Business Rule service engine that efficiently applies rules to facts and defines and processes rules.

Rules Engine has the following features:

- High performance: Rules Engine implements specialized matching algorithms for facts that are defined in the system.
- Thread-safe execution suitable for a parallel processing architecture: Rules Engine provides one thread that can assert facts while another is evaluating the network.

For more information, see [Section 1.3, "Oracle Business Rules Engine Architecture"](#).

## 1.2.2 Using Rules Engine with Oracle Business Rules in a Java EE Application

The Rules Engine is available as a library for use in a Java EE application (non-SOA). Rules Engine efficiently applies rules to facts and defines and processes rules. Rules Engine defines a Java-like production rule language called Oracle Business Rules RL Language (RL Language), provides a language processing engine (inference engine), and provides tools to support debugging.

Using Rules Designer you can specify business rules separately from application code which allows you to change business policies quickly with graphical tools. The Rules Engine evaluates the business rules and returns decisions or facts that are then used in the business process.

Rules Engine has the following features:

- High performance: Rules Engine implements specialized matching algorithms for facts that are defined in the system.
- Thread-safe execution suitable for a parallel processing architecture: Rules Engine provides one thread that can assert facts while another is evaluating the network.

A rule-enabled Java application can load and run rules programs. The rule-enabled application passes facts and rules to the Rules Engine (facts are asserted in the form of Java objects or XML documents). The Rules Engine runs in the rule-enabled Java application and uses the Rete algorithm to efficiently fire rules that match the facts.

For more information, see [Section 1.3, "Oracle Business Rules Engine Architecture"](#) and [Section 1.2.4, "Oracle Business Rules SDK"](#).

## 1.2.3 Oracle Business Rules RL Language

Oracle Business Rules supports a high-level Java-like language called Oracle Business Rules RL Language (RL Language). RL Language defines the valid syntax for Oracle Business Rules programs. RL Language includes an intuitive Java-like syntax for defining rules that supports the power of Java semantics, providing an easy-to-use syntax for application developers. RL Language consists of a collection of text statements that can be generated dynamically or stored in a file.

Using RL Language application programs can assert Java objects as facts, and rules can reference object properties and invoke methods. Likewise, application programs can use XML documents or portions of XML documents as facts.

Programmers can use RL Language as a full-featured rules programming language both directly and as part of the Oracle Business Rules SDK (Rules SDK).

Business analysts can use Rules Designer to work with rules. In this case, the business analyst does not need to directly view or write RL Language programs. For more information, see [Section 1.2.5, "Rules Designer"](#).

For detailed information about RL Language, see *Rules Language Reference for Oracle Business Process Management*.

## 1.2.4 Oracle Business Rules SDK

Oracle Business Rules SDK (Rules SDK) is a Java library that provides business rule management features that a developer can use to write a rule-enabled program that accesses a dictionary, or to write customized rules programs that add rules or modify existing rules. Rules Designer uses Rules SDK to create, modify, and access rules and the data model using well-defined interfaces. Customer applications can use Rules SDK to access, display, create, and modify collections of rules and the data model.

You can use the Rules SDK APIs in a rule-enabled application to access rules or to create and modify rules. The rules and the associated data model could be initially created in a custom application or using Rules Designer.

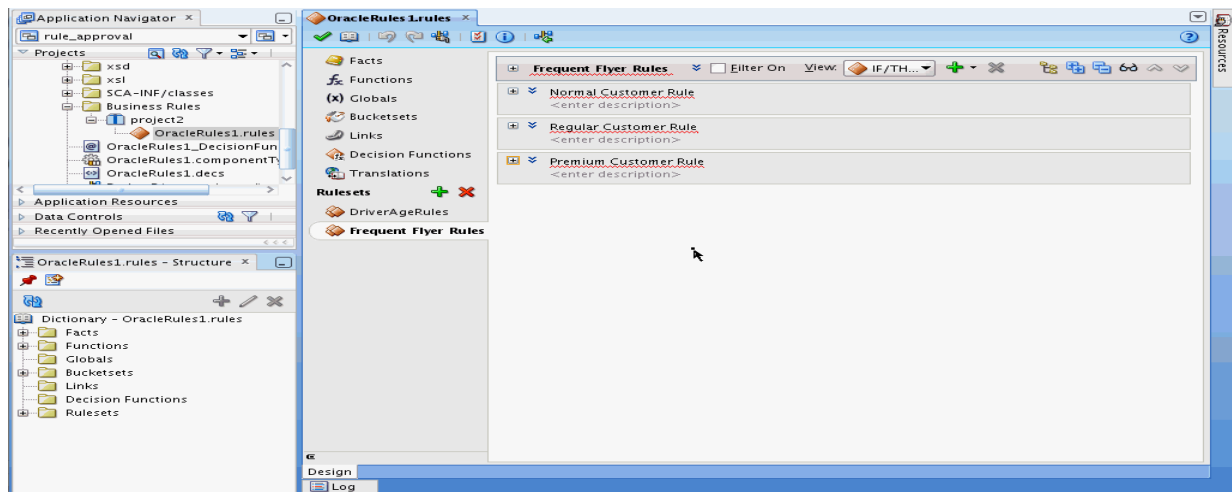
This guide describes the Oracle Business Rules SDK Decision Point API. Using a Decision Point you can access a dictionary and run the rules in the dictionary. For complete Oracle Business Rules SDK API information, see *Oracle Fusion Middleware Java API Reference for Oracle Business Rules*.

For more information, see [Chapter 7, "Working with Rules SDK Decision Point API"](#).

## 1.2.5 Rules Designer

The Oracle Business Rules Designer (Rules Designer) extension to Oracle JDeveloper is an editor that enables you to create and edit rules as [Figure 1–1](#) shows.

**Figure 1–1 Oracle JDeveloper with Rules Designer**

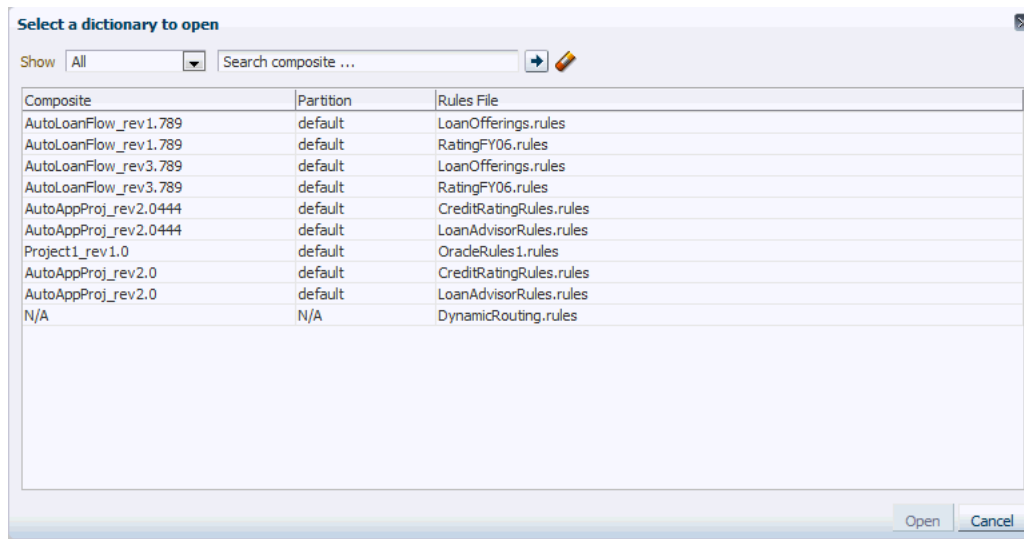


Rules Designer provides a point-and-click interface for creating rules and editing existing rules. Using Rules Designer you can work directly with business rules and a data model. You do not need to understand the RL Language to work with Rules Designer. Rules Designer provides an easy way for you to create, view, and modify business rules.

Rules Designer supports several types of users, including the application developer and the business analyst. The application developer uses Rules Designer to define a data model and an initial set of rules. The business analyst uses Rules Designer either to work with the initial set of rules or to modify and customize the initial set of rules according to business needs. Using Rules Designer a business analyst can create and customize rules with little or no assistance from a programmer.

## 1.2.6 Oracle SOA Composer Application

When a dictionary is deployed in a SOA composite application, Oracle Business Rules lets you view the dictionary or edit and save changes to the dictionary. You can use the SOA Composer application (SOA Composer) to work with a deployed dictionary that is part of a SOA composite application, as [Figure 1–2](#) shows.

**Figure 1–2 Using Oracle SOA Composer to View or Edit a Dictionary at Runtime**

For more information, see [Chapter 12, "Using Oracle SOA Composer with Oracle Business Rules"](#).

## 1.3 Oracle Business Rules Engine Architecture

A rule-based system using the Rete algorithm is the foundation of Oracle Business Rules. A rule-based system consists of the following:

- The rule-base: Contains the appropriate business policies or other knowledge encoded into IF/THEN rules and Decision Tables.
- Working memory: Contains the information that has been added to the system. With Oracle Business Rules you add a set of facts to the system using assert calls.
- Inference Engine: The Rules Engine, which processes the rules, performs pattern-matching to determine which rules match the facts, for a given run through the set of facts.

In Oracle Business Rules the rule-based system is a data-driven **forward chaining system**. The facts determine which rules can fire so when a rule fires that matches a set of facts, the rule may add facts and these facts are again run against the rules. This process repeats until a conclusion is reached or the cycle is stopped or reset. Thus, in a forward-chaining rule-based system, facts cause rules to fire and firing rules can create more facts, which in turn can fire more rules. This process is called an **inference cycle**.

### 1.3.1 Declarative Rules

With Oracle Business Rules you can use declarative rules, where you create rules that make declarations based on facts rather than coding. For an example of declarative rules,

```
IF a Customer is a Premium customer, offer them 10% discount
IF a Customer is a Gold customer, offer them 5% discount
```

In declarative rules:

- Statements are declared without any control flow
- Control flow is determined by the Rules Engine



- Rules are easier to maintain than procedural code
- Rules relate well to business user work methods

When a rule adds facts and these facts run against the rules, this process is called an **inference cycle**. An **inference cycle** uses the initial facts to cause rules to fire and firing rules can create more facts, which in turn can fire more rules. For example, using the initial facts, Rules Engine runs and adds an additional fact, and an additional rule tests for conditions on this fact creating an inference cycle:

```
IF a Customer is a Premium customer, offer them 10% discount
IF a Customer is a Gold customer, offer them 5% discount
IF a Customer spends > 1000, make them Premium customer
```

The inference cycle that Oracle Business Rules provides enables powerful and modular declarative assertions.

### 1.3.2 The RETE Algorithm

The Rete algorithm was first developed by artificial intelligence researchers in the late 1970s and is at the core of Rules Engines from several vendors. Oracle Business Rules uses the Rete algorithm to optimize the pattern matching process for rules and facts. The Rete algorithm stores partially matched results in a single network of nodes in working memory.

By using the Rete algorithm, the Rules Engine avoids unnecessary rechecking when facts are deleted, added, or modified. To process facts and rules, the Rete algorithm creates and uses an input node for each fact definition and an output node for each rule.

Fact references flow from input to output nodes. In between input and output nodes are test nodes and join nodes. A test occurs when a rule condition has a Boolean expression. A join occurs when a rule condition ANDs two facts. A rule is activated when its output node contains fact references. Fact references are cached throughout the network to speed up recomputing activated rules. When a fact is added, removed, or changed, the Rete network updates the caches and the rule activations; this requires only an incremental amount of work.

The Rete algorithm provides the following benefits:

- Independence from rule order: Rules can be added and removed without affecting other rules.
- Optimization across multiple rules: Rules with common conditions share nodes in the Rete network.
- High performance inference cycles: Each rule firing typically changes just a few facts and the cost of updating the Rete network is proportional to the number of changed facts, not to the total number of facts or rules.

### 1.3.3 What Is Working Memory?

Oracle Business Rules uses *working memory* to contain facts (facts do not exist outside of working memory). A RuleSession contains the Oracle Business Rules working memory.

### 1.3.4 Rule Firing and Rule Sessions

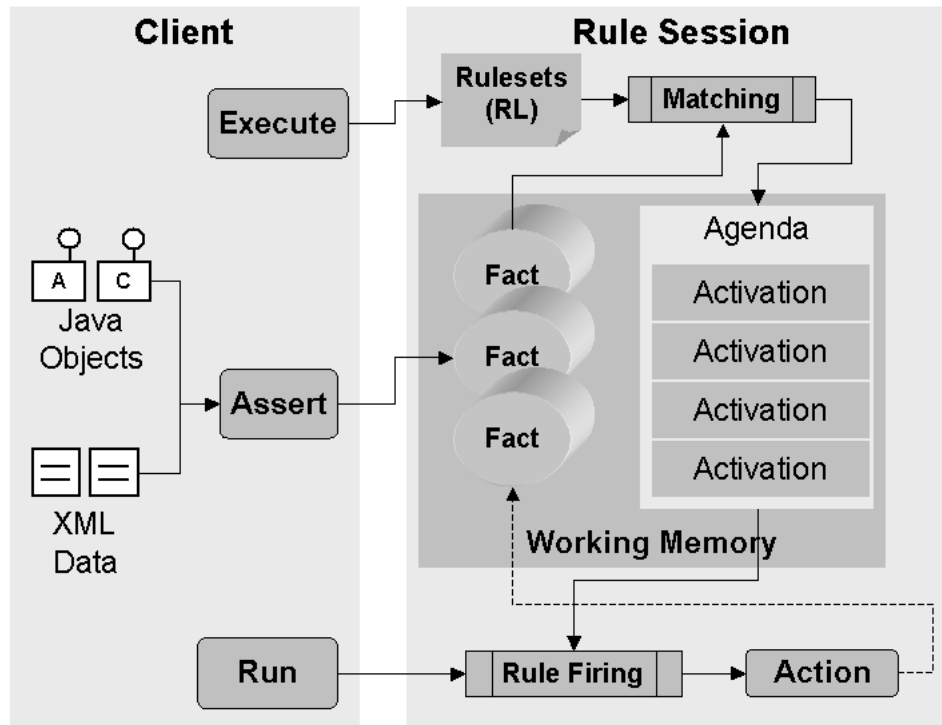
A Rule Session consists of rules, facts and an agenda. An assert or retract adds or removes fact instances from working memory.

When facts in working memory are changed:

- Conditions for rules are evaluated
- Matching rules are added to the agenda (Activated)
- Rules which no longer match are removed from agenda
- Rules Engine runs and executes actions (fires), for activated rules

Figure 1–3 shows these parts of Oracle Business Rules runtime.

**Figure 1–3 Rules in Rule Session with Working Memory and Facts**



A rule action may assert, modify, or retract facts and cause activations to be added or removed from the agenda. There is a possible loop if a rule's action causes it to fire again. Rules are fired sequentially, but in no pre-defined order. The rule session includes a ruleset stack. Activated rules are fired as follows:

- Rules within top-of-the-stack ruleset are fired
- Within a ruleset, firing is ordered by user-defined priority
- Within the same priority, the most recently activated rule is fired first

Only rules within rulesets on the stack are fired, but all rules in a rule session are matched and, if matched, activated.

---

---

## Working with Data Model Elements

This chapter describes the Oracle Business Rules data model comprising fact types, functions, globals, bucketsets, decision functions, and dictionary links.

The chapter includes the following sections:

- [Section 2.1, "Introduction to Working with Data Model Elements"](#)
- [Section 2.2, "Working with a Dictionary and Dictionary Links"](#)
- [Section 2.3, "Working with Oracle Business Rules Globals"](#)
- [Section 2.4, "Working with Decision Functions"](#)
- [Section 2.5, "Working with Oracle Business Rules Functions"](#)
- [Section 2.6, "Localizing Oracle Business Rule Resources"](#)

For more information, see [Section 1.1.8, "What Are Dictionaries?"](#).

### 2.1 Introduction to Working with Data Model Elements

To implement the data model portion of an Oracle Business Rules application you create a dictionary and add data model elements. To complete the dictionary, you create one or more rulesets containing rules that use or depend upon these data model elements.

For more information, see:

- [Chapter 3, "Working with Facts and Bucketsets"](#)
- [Chapter 4, "Working with Rulesets and Rules"](#)
- [Chapter 5, "Working with Decision Tables"](#)

### 2.2 Working with a Dictionary and Dictionary Links

A dictionary is an Oracle Business Rules container for facts, functions, globals, bucketsets, links, decision functions, and rulesets. A dictionary is an XML file that stores the rulesets and the data model for an application. Dictionaries can link to other dictionaries. You can create as many dictionaries as you need. A dictionary may contain any number of rulesets and data model elements. A data model can be contained in one or more dictionaries. All the data model elements referenced by the rulesets must be available in the dictionary either directly or through links.

A dictionary is stored in a \*.rules file.

## 2.2.1 Introduction to Dictionaries and Dictionary Links

When you create a dictionary, you give it a name and a package, similar to a Java class. You can create data model elements and rulesets inside this dictionary, and you can also reference the data models and rulesets of other dictionaries by creating a dictionary link and specifying the name and package of the target dictionary. Each dictionary logically contains the built-in dictionary. This dictionary includes standard functions and types that all Oracle Business Rules applications need. You cannot modify the built-in dictionary.

In addition to the main dictionary, you can create one or more application-specific dictionaries, such as `PurchaseItems.rules`. You can modify the properties of these dictionaries.

The complete data model defined by a dictionary and its linked dictionaries is called a **combined dictionary**. You can create multiple links to the same dictionary; in this case, all but the first link is ignored.

For more information, see [Section 2.2.7, "What You Need to Know About Dictionary Linking"](#).

## 2.2.2 How to Create a Dictionary in the SOA Tier Using Rules Designer

Oracle JDeveloper provides many ways to create a dictionary for Oracle Business Rules. This section shows one of the ways to create a dictionary in a SOA project. You can create a dictionary for use in a SOA application.

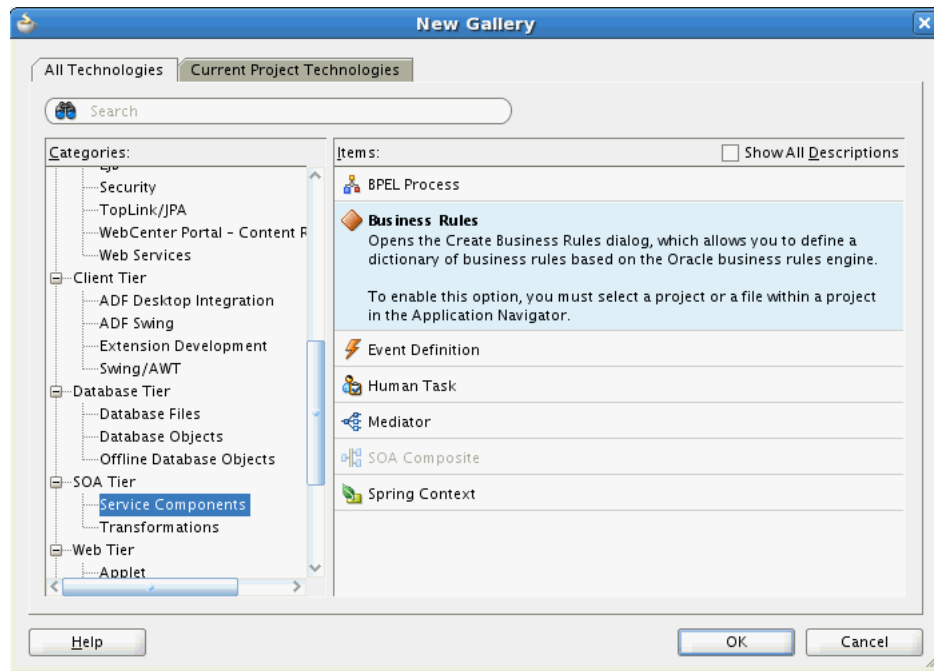
A typical SOA composite design pattern provides each application with its own dictionary or dictionaries. This makes each application self-contained and it can be deployed independently. When different applications need access to the same parts of a common data model, you can use dictionary links to include dictionary of a target application in the dictionary of a source application.

When you do this, application copies the dictionary of target application into the source application and retains the contents of the copies linked to the source. When you use the linked elements, they are shown as local contents.

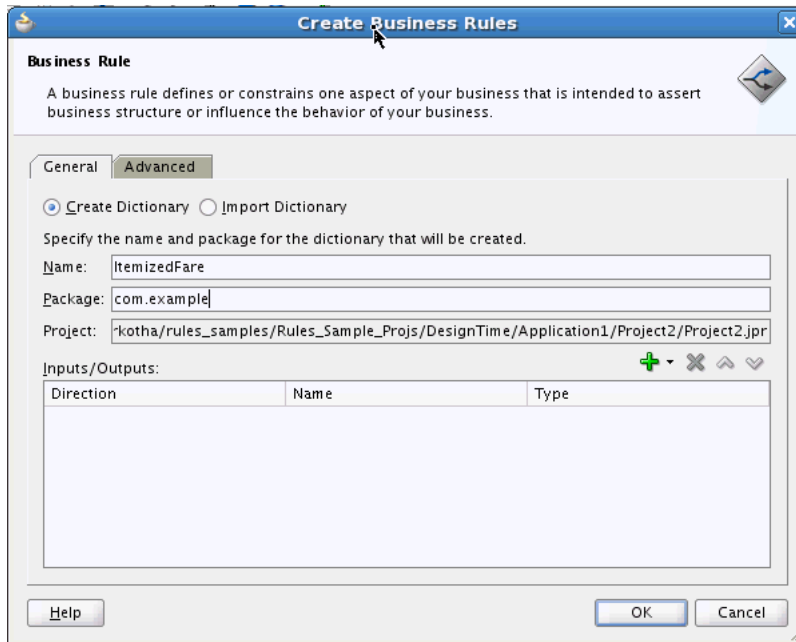
You may also create a dictionary in the business tier, for use outside of a SOA application. For more information, see [Section 9.2.5, "How to Create an Oracle Business Rules Dictionary in the Grades Project"](#).

### To create a dictionary in the SOA Tier using Rules Designer:

1. In the Application Navigator, select a SOA application and select or create a SOA project.
2. Right-click, and from the list select **New...**
3. In the New Gallery select the **Current Project Technologies** tab and, in the **Categories** area, expand **SOA Tier** as shown in [Figure 2-1](#).

**Figure 2–1** Creating a Business Rules Dictionary for a SOA Project

4. In the New Gallery window, in the **Items** area, select **Business Rules**.
5. Click **OK**. This displays the Create Business Rules dialog.
6. In the Create Business Rules dialog, enter fields as shown in [Figure 2–2](#):
  - In the **Name** field, enter the name of your dictionary. For example, enter PurchaseItems.
  - In the **Package** field, enter the Java package to which your dictionary belongs. For example, com.example.

**Figure 2–2 Create Business Rules Dialog**

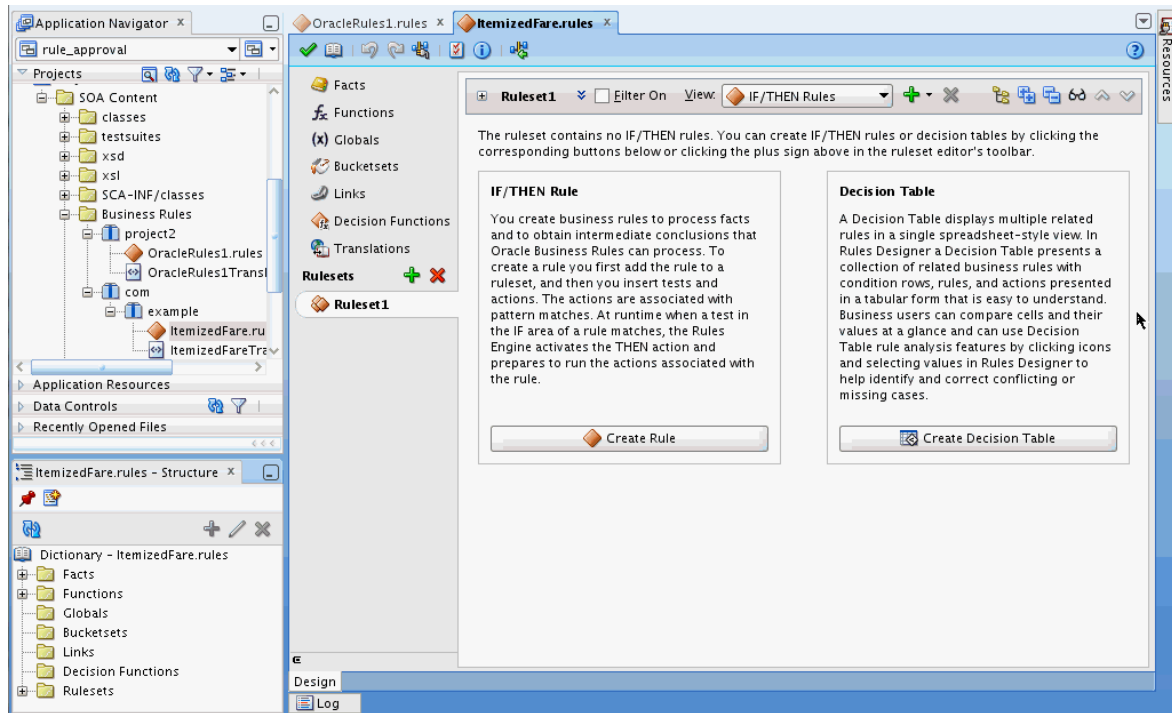
7. To specify the inputs and outputs:
  - a. Click the **Add** icon and select **Input** to create an input or **Output**, to create an output.
  - b. In the Type Chooser dialog, expand the appropriate XSD and select the appropriate type.
  - c. Click **OK** to close the Type Chooser dialog.

You can later add inputs or outputs, or remove the inputs or outputs. For more information, see [Chapter 6, "Working with Decision Functions"](#).

8. In the Create Business Rules dialog, click **OK** to create the Decision component and the Oracle Business Rules dictionary.

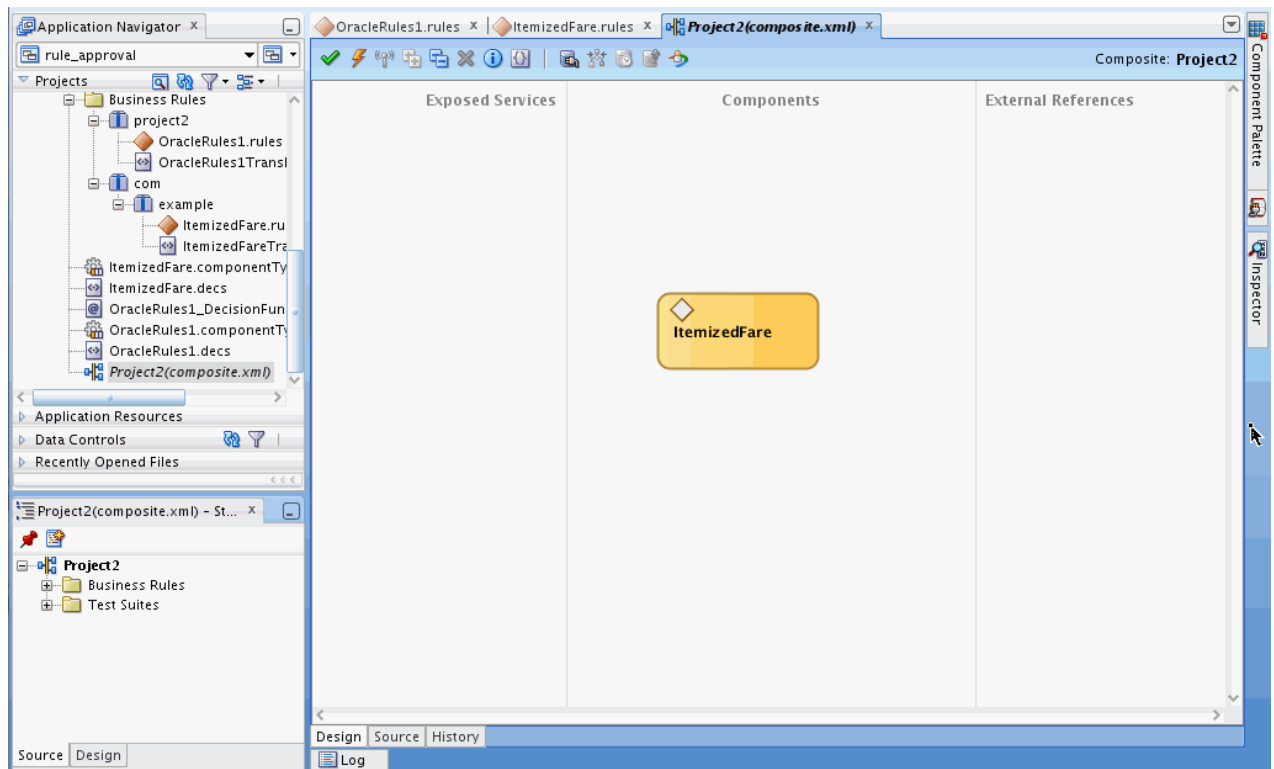
Oracle JDeveloper creates the dictionary in a file with a `.rules` extension, and starts Rules Designer as shown in [Figure 2–3](#).

Figure 2-3 Creating a New Oracle Business Rules Dictionary Purchaseltems



- Oracle JDeveloper also creates a Decision component in composite.xml. To view this component double-click the composite.xml file, as Figure 2-4 shows.

Figure 2-4 Decision Component Shown in Composite Editor



## 2.2.3 How to Create a Dictionary in the Business Tier Using Rules Designer

Use Rules Designer to create a rules dictionary for use in the business tier, outside of a SOA application. For information on using Oracle Business Rules without SOA, see [Chapter 9, "Creating a Rule-enabled Non-SOA Java EE Application"](#).

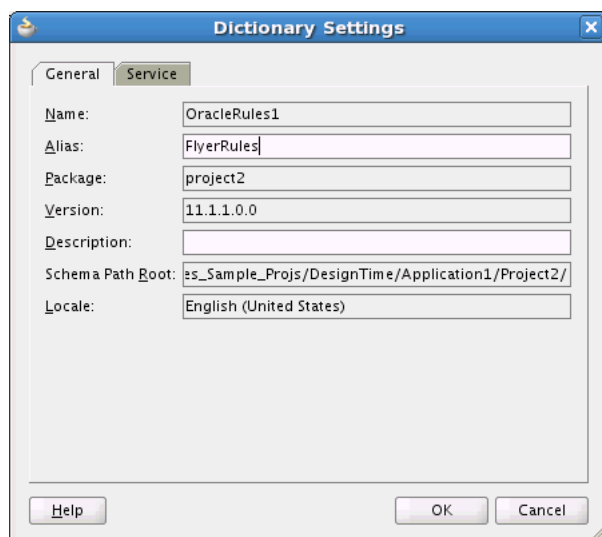
## 2.2.4 How to View and Edit Dictionary Settings

You can view and edit dictionary settings using the **Dictionary Settings** icon.

### To change the dictionary alias:

1. In Oracle JDeveloper, open an Oracle Business Rules dictionary.
2. In Rules Designer, click the **Dictionary Settings** icon.
3. In the Dictionary Settings dialog, in the **Alias** field, change the alias to the name you want to use. This field is shown in [Figure 2-5](#).

**Figure 2-5 Dictionary Settings Dialog to Change Dictionary Alias or Description**



4. Click **OK**.

## 2.2.5 How to Link to a Dictionary

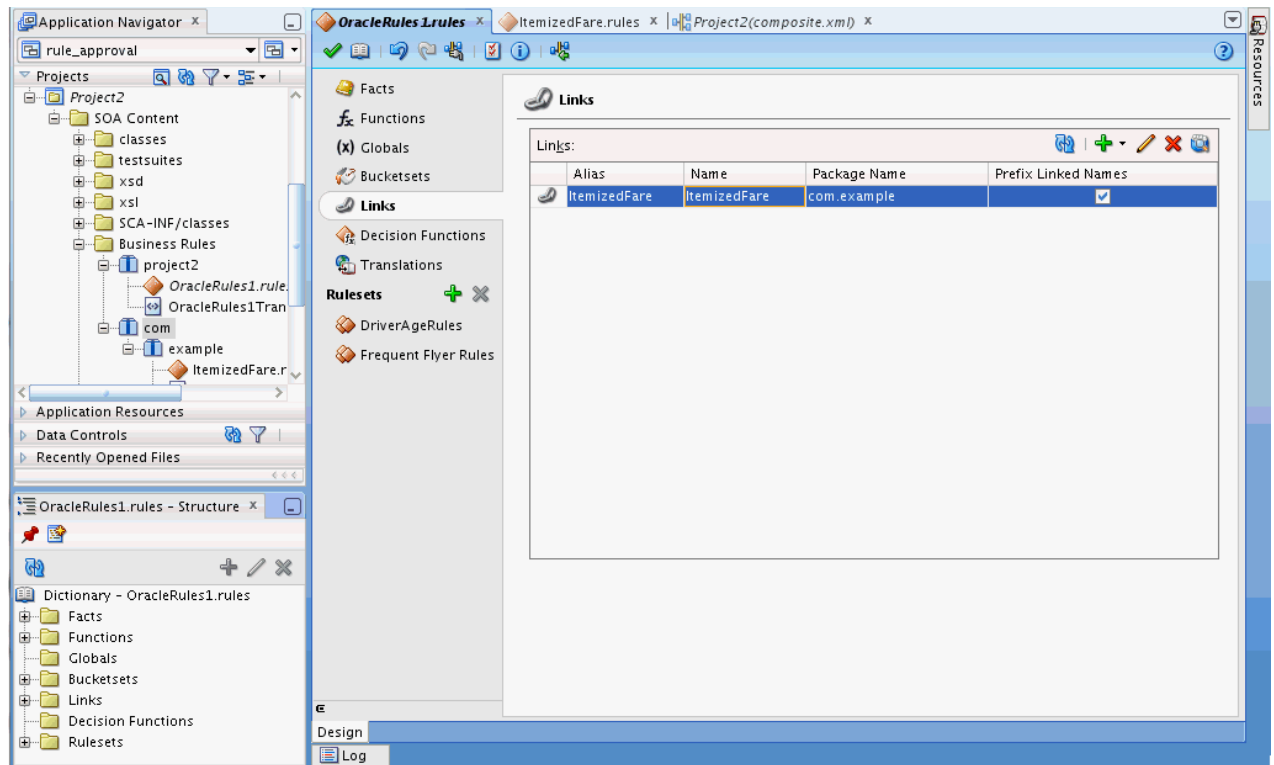
You can link to a dictionary in the same application or in another application using the **Links** navigation tab in Rules Designer. To link to another dictionary you need at least one other dictionary available.

### To link to a dictionary using resource picker:

1. In Rules Designer, click the **Links** navigation tab as shown in [Figure 2-6](#).

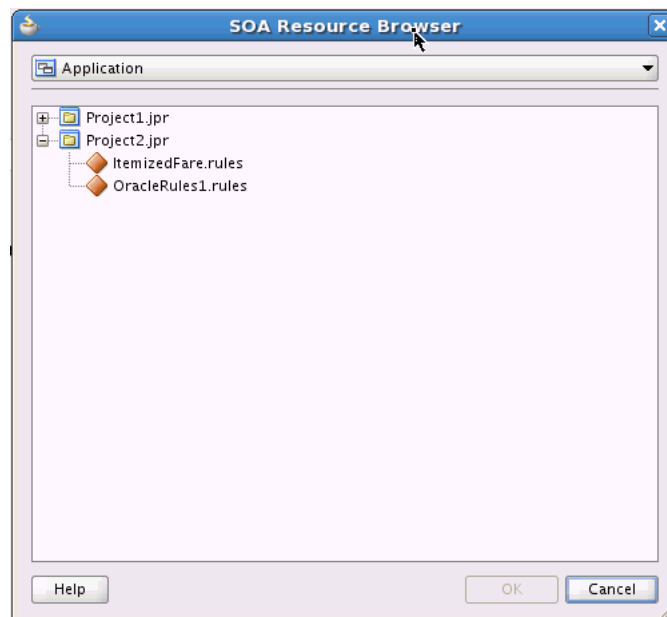


Figure 2-6 Rules Designer Links Tab



2. In the **Links** area, click the **Create** icon and from the list select **Browse Existing Dictionaries**. This displays the SOA Resource Browser dialog.
3. In the SOA Resource Browser dialog navigate to select the dictionary you want to link to as shown in Figure 2-7.

Figure 2-7 Resource Picker



4. Click **OK**.

When you work with ADF Business Components Facts you should create a link to the Decision Point Dictionary. For more information, see [Chapter 10, "Working with Oracle Business Rules and ADF Business Components"](#).

**To link to the decision point dictionary:**

1. In Rules Designer, click the **Links** navigation tab.
2. In the **Links** area, click **Create** and from the list select **Decision Point Dictionary**. This operation takes awhile. You need to wait for the Decision Point Dictionary to load.

## 2.2.6 How to Update a Linked Dictionary

When you have a dictionary, for example `Project_rules1` that links to another dictionary, for example, `Shared_rules` you need to see changes made to either dictionaries in both. For example, you can modify the `Shared_rules` dictionary and see those modifications in `Project_rules1` by updating the `Project_rules1` dictionary, or by closing and reopening the Rules Designer.

**To update a linked dictionary:**

1. Using these sample dictionary names click the **Save** icon to save the `Shared_rules` dictionary.
2. Select the `Project_rules1` dictionary.
3. Select the **Links** navigation tab.
4. Click the **Dictionary Cache...** icon.
5. In the Dictionary Finder Cache dialog, select the appropriate linked dictionary.
6. Click the **Clear** icon.
7. In the Dictionary Finder Cache dialog, click **Close**.
8. Click the **Validate** icon.

## 2.2.7 What You Need to Know About Dictionary Linking

Using a dictionary with links to another dictionary is useful in the following cases:

- **Data Model Sharing**, to share portions of a data model within a project. When you link to a dictionary in another project it is copied to the local project.

For example, consider a project where you would like to share some Oracle Business Rules Functions. You can create a dictionary that contains the functions, and name it `DictCommon`. Then, you can create two dictionaries, `DictApp1` and `DictApp2` that both link to `DictCommon`, and both can use the same Oracle Business Rules functions. When you want to change one of the functions, you only change the version in `DictCommon`. Then, both dictionaries use the updated function the next time RL Language is generated from either `DictApp1` or `DictApp2`.

In Oracle Business Rules a fully qualified dictionary name is called a DictionaryFQN and this consists of two components:

- **Dictionary Package:** The package name
- **Dictionary Name:** The dictionary name

A dictionary refers to a linked dictionary using its DictionaryFQN and an alias. Oracle Business Rules uses the DictionaryFQN to find a linked dictionary.

The following are the naming constraints for combined dictionaries:

- The full names of the dictionaries, including the package and name, must be distinct. In addition, the dictionary aliases must be distinct.
- The aliases of data model definitions of a particular kind, for example, function, Oracle RL class, or bucketset, must be unique within a dictionary.
- A definition may be qualified by the alias of its immediately containing dictionary. Definitions in the top and built-in dictionaries do not have to be qualified. Definitions in other dictionaries must be qualified and this qualification is controlled by the **prefix linked names** property of the dictionary link.
- Ruleset names must be unique within a dictionary. When RL Language for a ruleset is generated, the dictionary alias is not part of any generated name. For example, if the dictionary named dict1 links to dict2 to create a combined dictionary, and dict1 contains ruleset\_1 with rule\_1 and dict2 also contains ruleset\_1 with rule\_2, then in the combined dictionary both of these rules, rule\_1 and rule\_2 are in the same ruleset (ruleset\_1).
- All rules and Decision Tables must have unique names within a ruleset.  
For example, within a combined dictionary that includes dictionary d1 and dictionary d2, dictionary d1 may have a ruleset named Ruleset\_1 with a rule rule\_1. If dictionary d2 also has a ruleset named Ruleset\_1 with a rule\_2, then when Oracle Business Rules generates RL Language from the combined, linked dictionaries, both rules rule\_1 and rule\_2 are in the single ruleset named Ruleset\_1. If you violate this naming convention and do not use distinct names for the rules within a ruleset in a combined dictionary, Rules Designer reports a validation warning similar to the following:

```
RUL-05920: Rule Set Ruleset_1 has two Rules with name rule_1
```

For more information, see [Appendix A, "Oracle Business Rules Files and Limitations"](#).

## 2.2.8 What You Need to Know About Dictionary Linking and Dictionary Copies

When you create a dictionary link using the resource picker, the dictionary is copied to the source project (the project where the dictionary that you are linking from resides). Thus, this type of linking creates a local copy of the dictionary in the project. This is not a link to the original target, no matter where the target dictionary is. Thus, Rules Designer uses a copy operation for the link if you create a link with the resource picker.

## 2.2.9 What You Need to Know About Dictionary Linking to a Deployed Dictionary

When you are using Rules Designer you can browse a deployed composite application and any associated Oracle Business Rules dictionaries in the MDS connection. However, you cannot create a dictionary link to a dictionary deployed to MDS.

## 2.2.10 What You Need to Know About Business Rules Inputs and Outputs with BPEL

Decision function inputs are available as variables to the initial actions of the decision function. When the inputs are facts, the facts are asserted into working memory and rules must match the facts based on type and property values and not on decision function input name. For example, if you have inputs of same type, *input1* and *input2*, rules distinguish these inputs based on type or property values and not on the different names they have.

When the inputs are not visible facts, for example String or int, then a wrapper type named *<decision function name>* is created, and rules must match this type.

## 2.3 Working with Oracle Business Rules Globals

You can use Rules Designer to add Oracle Business Rules globals.

In Oracle Business Rules a global is similar to a public static variable in Java. You can specify that a global is a constant or is modifiable.

You can use global definitions to share information among several rules and functions. For example, if a 10% discount is used in several rules you can create and use a global Gold Discount, so that the appropriate discount is applied to all the rules using the global.

Using global definitions can make programs modular and easier to maintain.

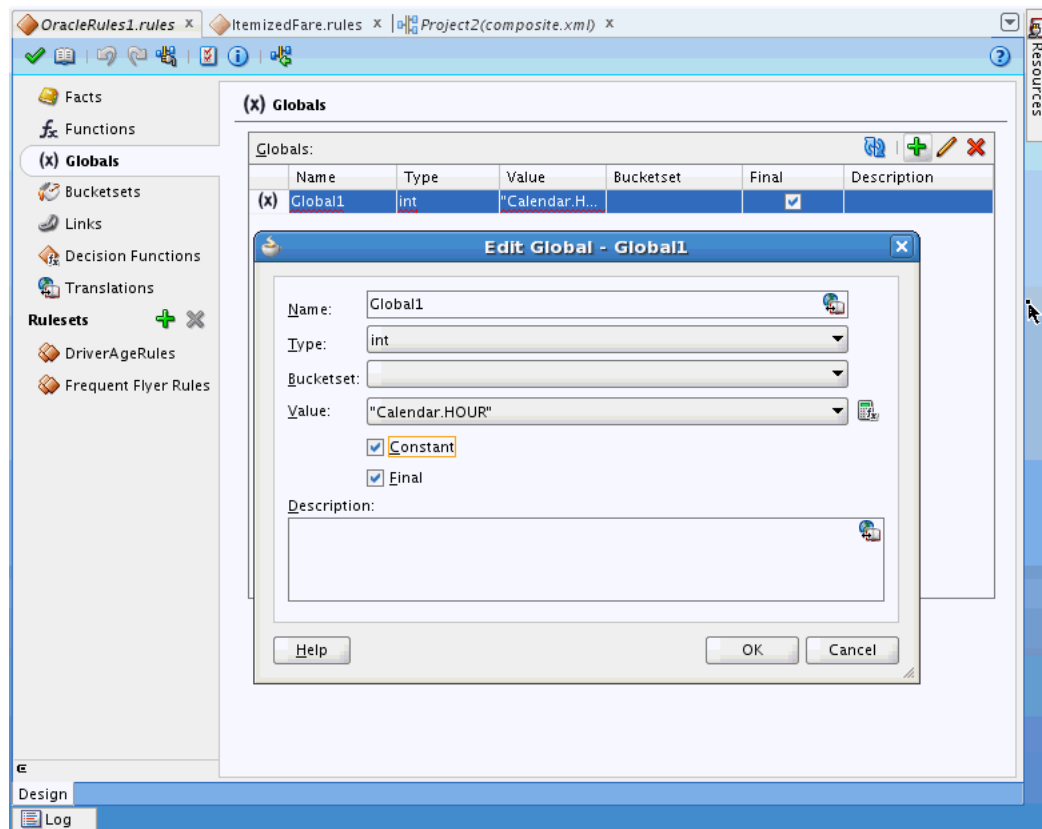
### 2.3.1 How to Add Oracle Business Rules Globals

You can use Rules Designer to add globals.

#### To add a global:

1. In Rules Designer, select the **Globals** navigation tab.
2. In the globals table, click the **Create** icon. This adds a global and displays the Edit Global dialog, as shown in [Figure 2–8](#).

**Figure 2–8 Adding a Global in Rules Designer**



3. In the **Name** field, enter a name or accept the default value.

4. In the **Type** field, select the type from the list.
5. Optionally, in the **Bucketset** field, select a value from the list.
6. In the **Value** field, enter a value, select a value from the list, or click the **Expression Builder** icon to enter an expression. For more information, see [Section 4.10, "Working with Expression Builder"](#).
7. If the global is a constant, then select the **Constant** checkbox. When selected, this option specifies that the global is a constant value. For more information, see [Section 2.3.3, "What You Need to Know About the Final and Constant Options"](#).
8. If the global is a nonfinal, then deselect the **Final** checkbox. When unselected, this option specifies that the global is modifiable, for instance, in an assign action.

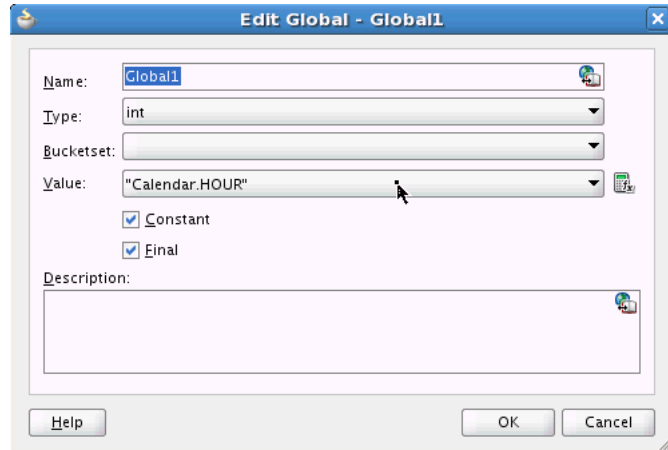
## 2.3.2 How to Edit Oracle Business Rules Globals

You can use Rules Designer to edit globals.

### To edit a Global:

1. In Rules Designer, select the **Globals** navigation tab.
2. Double-click the globals icon in a row in the Globals table. When you double-click the globals icon in a row this displays the **Edit Global - Global Name** window as shown in [Figure 2-9](#). In this window you can edit a global and change field values, including the **Final** field and the **Constant** field (the **Constant** field is only shown when you double-click a global to display the Edit Global dialog).

**Figure 2-9** Edit Global Window



## 2.3.3 What You Need to Know About the Final and Constant Options

The Edit Global dialog shows the **Constant** and **Final** checkboxes that you can select for a global.

Note the following when you use globals:

- When you deselect **Final**, this specifies that the global is modifiable, for instance, in an assign action.
- When you select **Final**, this specifies that you can use the globals in a test in a rule (nonfinal globals cannot be used in a test in a rule).

- When you select **Final**, this specifies that the global is initialized one time at runtime and cannot be changed.

When you select the **Constant** option in the Edit Global dialog, this specifies the global is a constant. In Oracle Business Rules a constant is a string or numeric literal, a final global whose value is a constant, or a simple expression involving constants and +, -, \*, and /.

Selecting the **Constant** option for a global has three effects:

- You do not have to surround string literals with double quotes.
- Only constants appear in the expression value choice list.
- The expression value must be a constant to be valid.

Selecting the **Constant** option is optional. Note that bucket values, bucket range endpoints, and ruleset filter values are always constant.

## 2.4 Working with Decision Functions

The data model includes decision functions. For information on working with decision functions, see [Section 6.1, "Introduction to Decision Functions"](#).

## 2.5 Working with Oracle Business Rules Functions

Oracle Business Rules provides functions to hide complexity when you create rules. Oracle Business Rules lets you use built-in or user-defined functions in rule and Decision Table conditions and actions.

### 2.5.1 Introduction to Oracle Business Rules Functions

In Oracle Business Rules you define a function in a manner similar to a Java method, but an Oracle Business Rules function does not belong to a class. You can use Oracle Business Rules functions to extend a Java application object model so that users can perform operations in rules without modifying the original Java application code.

You can use an Oracle Business Rules function in a condition or in an action associated with a rule or a Decision Table.

You can also use an Oracle Business Rules function definition to share the same or a similar expression among several rules, and to return results to the application.

An Oracle Business Rules function includes the following:

- **Name:** The Oracle Business Rules function name.
- **Return Type:** A return type for the Oracle Business Rules function, or void if there is no return value.
- **Bucketset:** The bucketset to associate with the Oracle Business Rules function.
- **Arguments:** The function arguments. Each function argument includes a name and a type.
- **Function Body:** The function body includes predefined actions. Using predefined actions Rules Designer assures that an Oracle Business Rules function is well formed and can be validated.

You can also use functions to test rules from within Rules Designer. For more information, see [Section 8.1.5, "How to Test a Decision Function Using an Oracle Business Rules Function"](#).

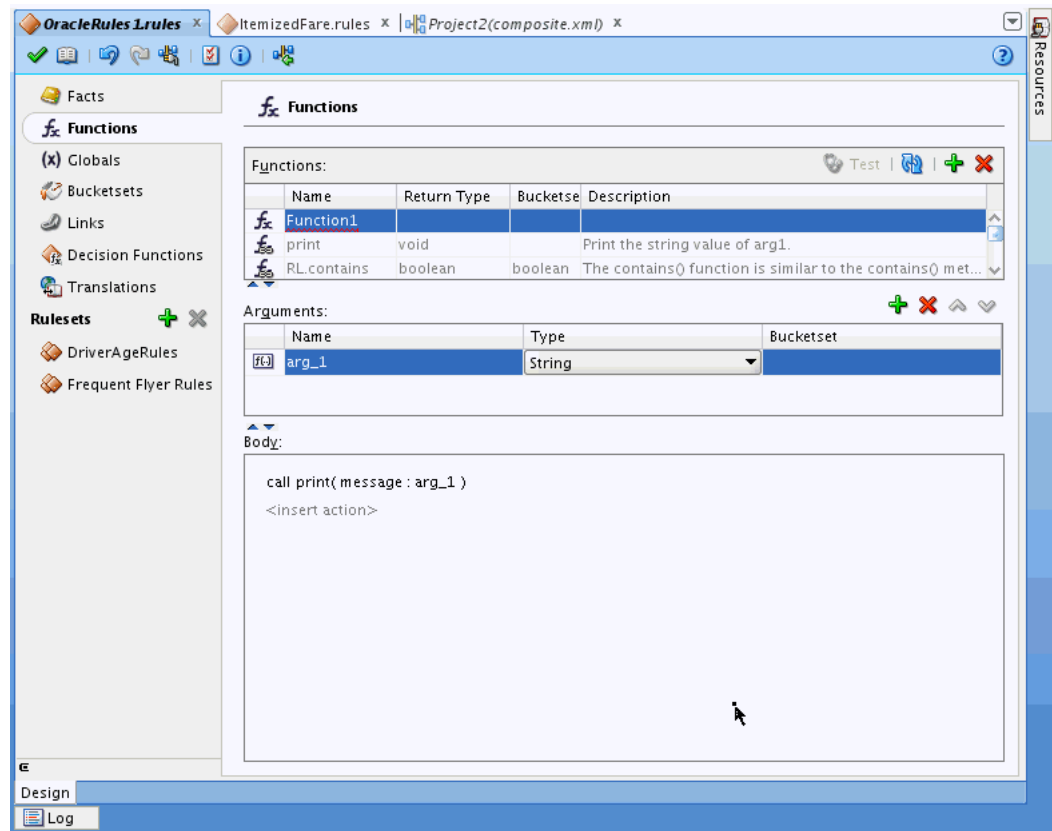
## 2.5.2 How to Add an Oracle Business Rules Function

You use Rules Designer to add an Oracle Business Rules function.

### To add an Oracle Business Rules Function:

1. In Rules Designer, select the **Functions** navigation tab.
2. Select the **Create...** icon.
3. Enter the function name in the **Name** field, or use the default name.
4. Select the return type from the **Return Type** list. For example, select `void`.
5. Optionally, select a bucketset to associate with the function return type from the list in the **Bucketset** field.
6. Optionally, in the **Description** field enter a description.
7. In the Arguments table, click **Add** to add one or more arguments for the function.
8. For each argument in the **Type** field, select the type from the list.
9. For each argument in the **Bucketset** field, to limit the argument values as specified by a bucketset constraint, select a bucketset from the list.
10. In the **Body** area, enter actions and arguments for the function body. You can add any required action ranging from `assert`, `call`, `modify` to even conditional actions such as `if`, `else`, `elseif`, `while`, `for`, `if (advanced)`, and `while (advanced)`. For example, see [Figure 2-10](#).

**Figure 2-10 Adding an Oracle Business Rules Function**



## 2.6 Localizing Oracle Business Rule Resources

You can localize the names, aliases and descriptions of rules resources. This enables better control of these resources in Workspace and SOA Composer. You can localize most of the resources like Buckets, Bucketsets, Globals, Rulesets, Rules and so on.

When you create these resources, you can add locale-specific information from the Translations tab. Each locale is stored in a separate resource bundle.

---

---

**Note:** You should not manually edit the resource bundle to add or edit localized strings. You must edit the resource bundle using the Translation tab of the Rules Designer in JDeveloper or SOA Composer.

---

---

### 2.6.1 How to Localize the Resources in Oracle Business Rules

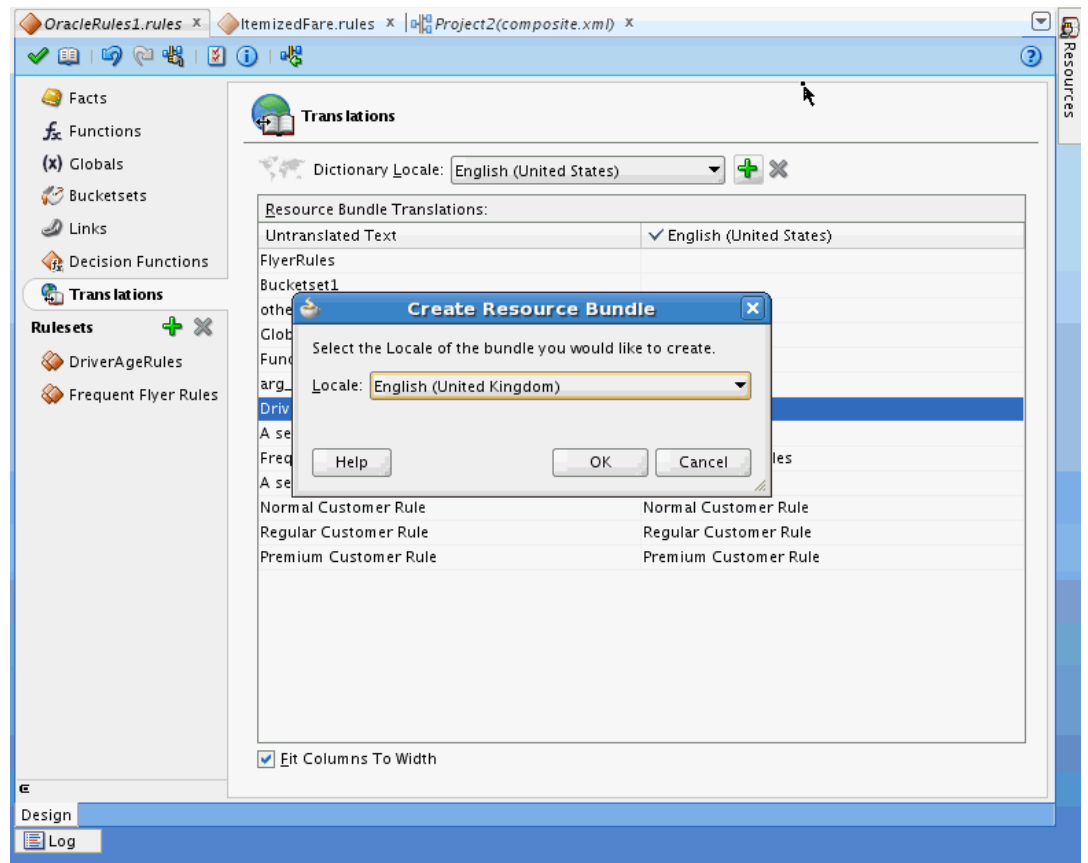
You can use the Rules Designer of JDeveloper to localize the resources of a business rule.

**To localize business rule resources:**

1. In Rules Designer, select the **Translations** tab.
2. Click the **Create Resource Bundle** icon.  
Create **Resource Bundle** screen appears.
3. Select the **Locale** from the list.
4. Click **OK**.



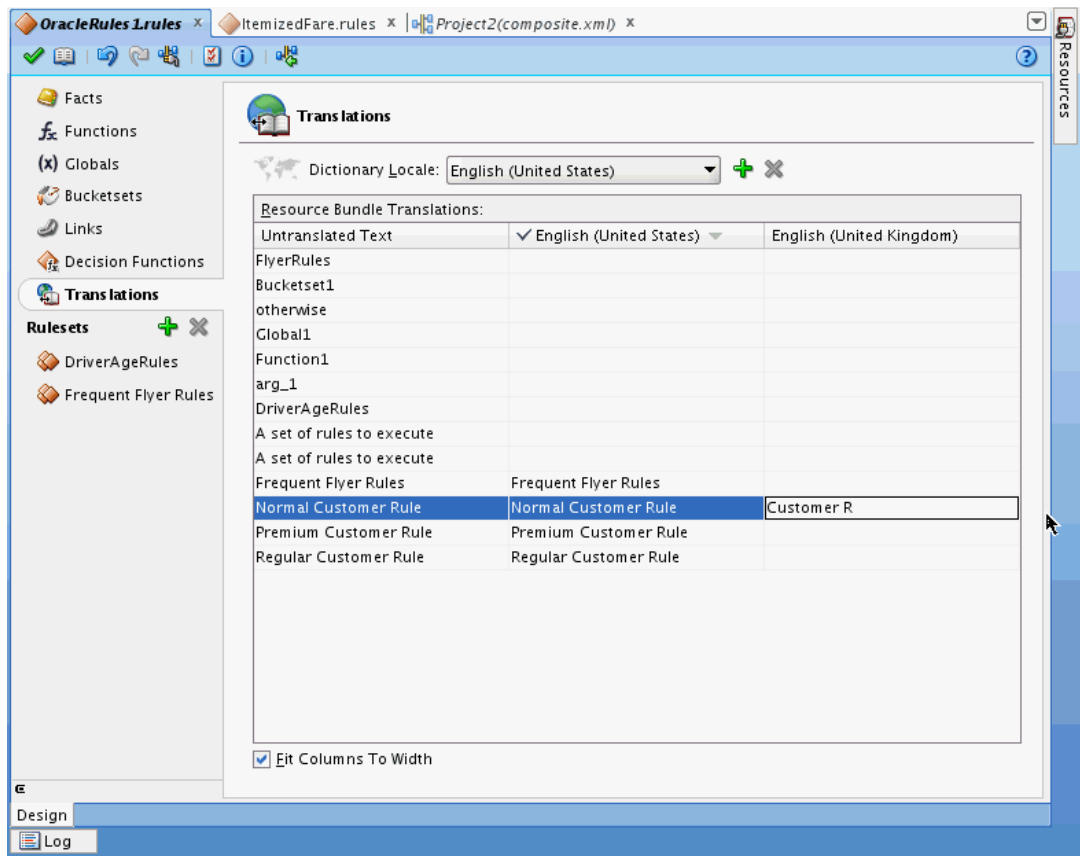
Figure 2–11 Adding New Locales



Each locale that you add appears as a column in the Resource Bundle Translations table. Each resource of the business rule appears as a row in this table. Each locale is stored as a separate resource bundle

5. Double click the cell of the table corresponding to the resource and locale and enter the localized text.

Figure 2–12 Localizing Rule Resources



---

---

## Working with Facts and Bucketsets

This chapter describes the Oracle Business Rules data model element called Facts, which are the objects that rules reason on. It also covers another element called Bucketsets that define groupings of fact property values.

The chapter includes the following sections:

- [Section 3.1, "Introduction to Working with Facts and Bucketsets"](#)
- [Section 3.2, "Working with XML Facts"](#)
- [Section 3.3, "Working with Java Facts"](#)
- [Section 3.4, "Working with RL Facts"](#)
- [Section 3.5, "Working with ADF Business Components Facts"](#)
- [Section 3.6, "Working with Bucketsets"](#)
- [Section 3.7, "Associating a Bucketset with Business Terms"](#)

### 3.1 Introduction to Working with Facts and Bucketsets

In Rules Designer, you make business objects and their methods known to Oracle Business Rules using fact types that are part of a data model.

You can create fact types and bucketsets before you create rules.

In Rules Designer you can work with the following kinds of facts:

- **XML Facts:** XML Facts are imported from existing sources by specifying XML Schema. You can add aliases to imported XML Facts or use XML Facts with RL Facts to change the data model according to your business needs.

For more information, see [Section 3.2, "Working with XML Facts"](#).

- **Java Facts:** Java Facts are imported from existing sources. You can add aliases to Java Facts or use them with RL Facts to target the data model to business needs. Java Facts are also used to import supporting Java classes for use with the rules or Decision Tables that you create.

For more information, see [Section 3.3, "Working with Java Facts"](#).

- **RL Facts:** RL Facts are the only kind of facts that you can create directly and do not have an external source. All other types of Oracle Business Rules facts are imported. An RL Fact is similar to a relational database row or a JavaBean without methods. An RL Fact contains a list of properties of types available in the data model, either RL Facts, Java Facts, or primitive types. You can use RL Facts to extend a Java application object model by providing virtual dynamic types.

For more information, see [Section 3.4, "Working with RL Facts"](#).

- **ADF Business Components Facts:** ADF Business Components Facts allow you to use ADF Business Components as Facts in rules and in Decision Tables. By using ADF Business Components Facts you can assert view object graphs representing the business objects upon which rules should be based, and let Oracle Business Rules deal with the complexities of managing the relationships between the various related view objects in the view object graph.

For more information, see [Section 3.5, "Working with ADF Business Components Facts"](#).

You typically use Java fact types and XML fact types to create rules that examine the business objects in a rule-enabled application, or to return results to the application. You use RL Language fact type definitions to create intermediate facts that can trigger other rules in the Rules Engine. ADF Business Components fact types enables you to use ADF Business Components as Facts in rules and in Decision Tables.

In Oracle Business Rules, facts that you can run against the rules are data objects that have been asserted. Each object instance corresponds to a single fact. If an object is re-asserted (whether it has been changed or not), the Rules Engine is updated to reflect the new state of the object. Re-asserting the object does not create a fact. To have multiple facts of a particular fact type, separate object instances must be asserted.

You can create bucketsets to define a list of values or a range of values of a specified type. After you create a bucketset, you can associate the bucketset with a business term of matching type. When a bucketset is associated with a business term, Oracle Business Rules uses the buckets that you define as constraints for the values for the business terms in rules or in Decision Tables.

For more information, see:

- [Section 3.6, "Working with Bucketsets"](#)
- [Section 3.7, "Associating a Bucketset with Business Terms"](#)

## 3.2 Working with XML Facts

The XML fact type allows XML Schema types, elements, and attributes to be used when writing rules. Elements and types defined in XML Schema can be imported into the data model and can then be used to create rules and Decision Tables, just as with Java fact types and RL Fact types. The mapping between the XML Schema definition and the XML Fact types uses the Java Architecture for XML Binding (JAXB). By default, Oracle Business Rules uses the JAXB 2.0 shipped with the Oracle Application Server. JAXB as defined in JSR-222 provides a mapping between the types, names, and conventions in an XML Schema definition and the available types, allowed names and conventions in Java. For example, an element named `order-id` and of type `xsd:integer` is mapped to a Java Bean property named `orderID` of type `BigInteger` (and `xsd:int` type maps to Java `int`).

Thus, with Oracle Business Rules if you have an XML document that contains data associated with your application and you have the schema associated with the XML document then you can use Rules Designer to define rules based on elements that you specify from the XML Schema.

To create XML fact types, perform the following steps:

1. Define or obtain an XML Schema.
2. Use Rules Designer to import the XML Schema into a dictionary. This step uses the JAXB compiler to generate Java classes from the XML Schema. After you compile

the XML Schema, you select the desired elements from the schema to add XML Facts in the data model and import the generated JAXB classes into the data model. For more information on these steps, see [Section 3.2.1, "How to Import XML Schema and Add XML Facts"](#).

3. Write rules or create Decision Tables based on these XML Facts that you added to the data model. For more information, see [Section 4.3, "Working with Rules"](#) and [Section 5.2, "Creating Decision Tables"](#).

Elements and types defined in XML Schema can be imported into the data model so that instances of types can be created, asserted, modified, and retracted by rules. Most XML documents describe hierarchical information, where each element contains subelements. It is common for users to want to write individual rules based on multiple elements in this hierarchy, and the hierarchical relationship among the elements. In Oracle Business Rules the default behavior when you `assert` a fact is to only assert the single fact instance, and none of the child objects it may reference in the hierarchy of subelements. When you create rules or a Decision Table it is often desirable to assert an entire hierarchy of elements based on a reference to a root element. Oracle Business Rules provides the `assertTree` action type that allows for a recursive assert for a hierarchy. For more information, see [Section 4.8, "Working with Tree Mode Rules"](#).

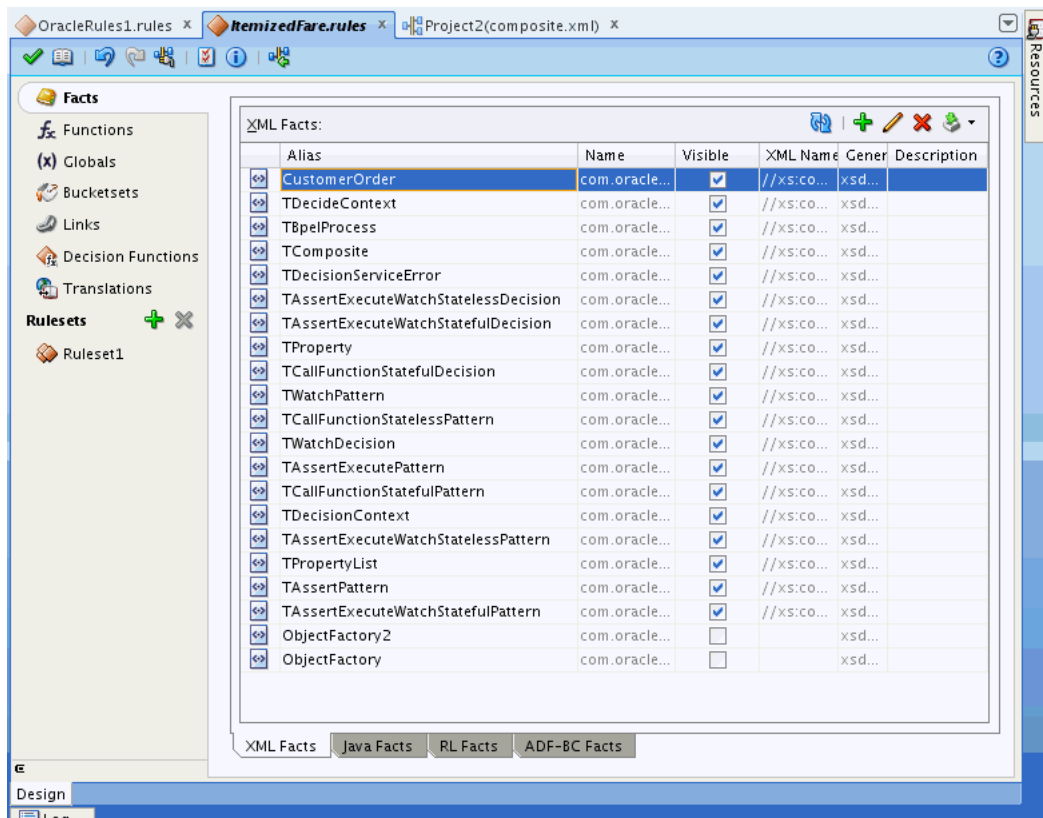
### 3.2.1 How to Import XML Schema and Add XML Facts

Before you can use XML Schema definitions in a data model you must import XML schema. This step generates the JAXB classes and makes the generated classes and packages associated with the XML schema visible in Rules Designer.

#### To import XML schema and add XML facts:

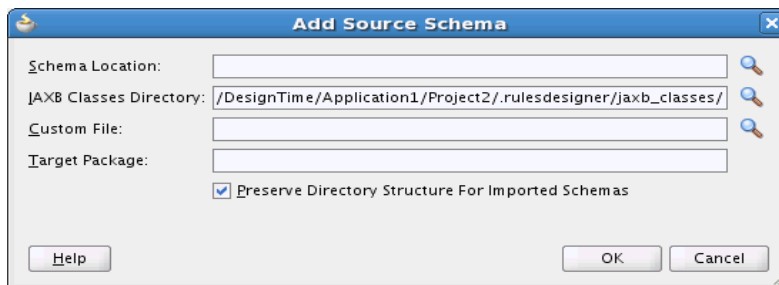
1. In Rules Designer, select the **Facts** navigation tab.
2. Select the **XML Facts** tab on the **Facts** navigation tab, as shown in [Figure 3-1](#).

Figure 3–1 The XML Facts Tab in Rules Designer



3. In the XML Facts tab, click **Create...** This displays the Create XML Fact dialog.
4. In the Create XML Fact dialog, in the **Source Schemas** area, click **Add Source Schema...** This displays the Add Source Schema dialog, as shown in Figure 3–2.

Figure 3–2 XML Fact: Add Source Schema Dialog



5. In the Add Source Schema dialog,
  - Enter the location of the XML Schema you want to import, or click **Browse** to locate the XML schema in the **Schema Location** field. During the import the file is copied into the project.

---

**Note:** Typically, the XML schema (xsd) file is located inside the xsd folder because any XML schema that is created needs to be stored inside the xsd folder under SOAContent.

---

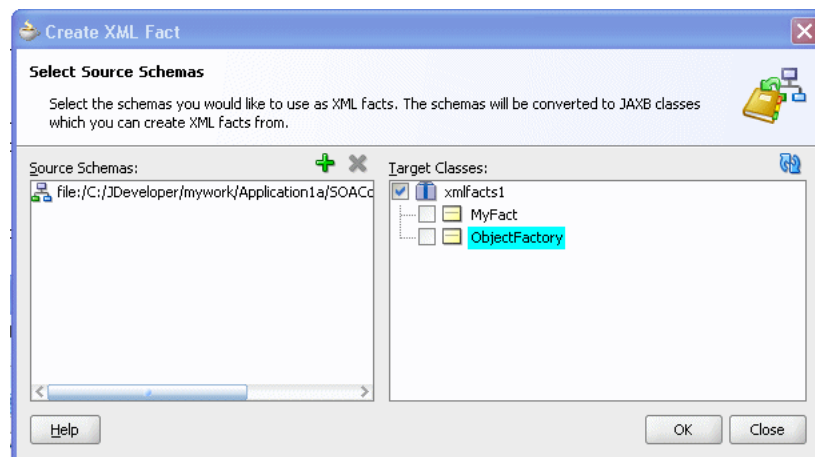
- Accept the default path or enter the directory where you want Rules Designer to store the JAXB-generated Java source and class files in the **JAXB Classes Directory** field.
- Enter a target package name or leave this field empty in the **Target Package** field. If you leave this field empty the JAXB classes package name is generated from the XML target namespace of the XML schema using the default JAXB XML-to-Java mapping rule or explicitly defined package name using annotations, or "generated" if no namespace or annotation is defined. Using the schema namespace is preferred.

For example, the namespace `http://www.oracle.com/as11/rules/demo` is mapped to `com.oracle.as11.rules.demo`.

- Click OK.

Rules Designer processes the schema and compiles the JAXB, so depending on the size of the schema this step may take some time to complete. When this step completes Rules Designer displays the Create XML Fact dialog with the **Target Classes** area updated to include the JAXB classes, as shown in [Figure 3–3](#).

**Figure 3–3 XML Fact: Create XML Fact Dialog**



6. In the Create XML Fact dialog, in the **Target Classes** area, select the classes you want to import as XML fact types.
7. Click OK.

### 3.2.2 How to Display and Edit XML Facts

To work with an XML Fact, in Rules Designer open the Edit XML Fact dialog.

#### To display and edit XML facts:

1. In Rules Designer, select the **Facts** navigation tab.
2. Select the **XML Facts** tab on the **Facts** navigation tab.
3. In the XML Facts table, double-click the icon for the XML Fact you want to edit. This displays the Edit XML Fact dialog, as shown in [Figure 3–4](#).

**Figure 3–4 Edit XML Fact Dialog**

**Edit XML Fact** - com.oracle.xmlns.oraclerules1.oraclerules1\_decisionfunction1.TCallFunctionSt

Name: com.oracle.xmlns.oraclerules1.oraclerules1\_decisionfunction1.TCallFunctionStatelessDecision

Alias: CustomerOrder

Super Class: TDecisionContext

XML Name: //xs:complexType[@name='tCallFunctionStatelessDecision']

Generated From: xsd/OracleRules1\_DecisionFunction1Types.xsd

Visible

Support XPath Assertion

Description: Customer Order Information

Attributes

Properties

Alias	Visible	Name	Type	Bucketset	List Content Type	Description
ecid	<input checked="" type="checkbox"/>	ecid	String			
resultList	<input checked="" type="checkbox"/>	resultList	Object			

Edit Columns To Width

Attribute Description:

Help OK Cancel

The Edit XML Fact dialog includes the fields shown in [Table 3–1](#).

**Table 3–1 XML Fact: Edit XML Fact Dialog Fields**

Field	Description
Name	Displays the XML Fact name. You cannot change the name of JAXB generated class.
Alias	Enter the XML Fact alias. You can change this value. This defaults to the unqualified name of the class.
Super Class	Displays Java super class associated with this fact.
Description	Enter the XML Fact description.
XML Name	Displays the XML name associated with the XML Fact.
Generated From	Displays the XML schema file that was the source for the XML Fact when it was copied into the business rules data model.
Visible	Select to show the XML Fact in lists in Rules Designer. XML Facts often reference other XML Facts, forming a tree. You should make all the XML fact types visible that contain properties that you reference in rules.
Support XPath Assertion	Select to enable XPath assertion for the fact. This feature is provided for backward compatibility only. Typically, this option is not used.
Attributes area	Select the available constructors, properties, methods, or fields associated with the JAXB class for the XML Fact to display or edit.



### 3.2.3 How to Reload XML Facts with Updated Schema

If an XML schema changes in a project, the schema must be reimported into the Oracle Business Rules dictionary. When you reimport the schema, Oracle Business Rules uses JAXB to recompile all source schemas for every XML fact type and updates the XML fact type definitions with the updated XML schema definitions. You should reimport facts if you changed the schema or classes and you want to use the changed schema or classes at runtime.

---



---

**Note:** When the XML schema on which an XML fact is based changes, on reimporting the schema, the facts are updated and imported into the base dictionary. When working with facts in a linked dictionary, you need to reload the XML facts for the changed schema from the base dictionary instead of the linked dictionary.

---



---

#### To reimport XML facts:

1. In Rules Designer, select the **Facts** navigation tab.
2. Select the **XML Facts** tab on the **Facts** navigation tab.
3. On the XML Facts page, click the **Reload XML Facts from Updated Schemas** icon.

After the reimport operation you need to correct any validation warnings that may be caused by incompatible changes (for example, the updated schema may include a change that removed a property that is referenced by a rule).

### 3.2.4 What You Need to Know About XML Facts

Keep the following points in mind when you work with XML Facts:

- When writing rules, the `assertTree` action type is available only in advanced mode. For more information on creating rules using `assertTree`, see [Section 4.8, "Working with Tree Mode Rules"](#).
- When creating a decision function, the `tree` option for the input types defines whether `assert` or `assertTree` is used to put the input facts in working memory. For more information on `assertTree`, see [Section 4.8, "Working with Tree Mode Rules"](#).
- When XML Schema contain a `restriction` definition, this allows a user to restrict the types that are valid for use in an element. A common use of `restriction` is to define an enumeration of strings which can be used for an element, as shown in [Example 3–1](#).

#### **Example 3–1 XML Schema Restriction Example**

```
<xs:simpleType name="status-type">
  <xs:restriction base="xs:string">
    <xs:enumeration value="manual"/>
    <xs:enumeration value="approved"/>
    <xs:enumeration value="rejected"/>
  </xs:restriction>
</xs:simpleType>
```

Oracle JAXB 2.0 maps a `restriction` to a Java `enum` type. When you use Rules Designer to import either a Java `enum` type or an element with an XML `restriction`, the static final fields representing the enums are available for use in expressions. Additionally, Oracle Business Rules creates a bucketset for each `enum` containing

all of the enum values and null. For more information on bucketsets, see [Section 3.6, "Working with Bucketsets"](#).

- There is a default version of the JAXB binding compiler supplied with Oracle Application Server. You can use a different JAXB binding compiler. However, to use a different JAXB binding compiler you must manually perform the XML schema processing and then import the generated Java packages and classes into the data model as Java Facts.

For more information about JAXB, see

<http://java.sun.com/webservices/jaxb/>

- You should reimport facts if you changed the schema or classes and you want to use the changed schema or classes at runtime. You should correct any validation warnings that may be caused by incompatible changes (for example, removing a property that is referenced by a rule). For more information, see [Section 3.2.3, "How to Reload XML Facts with Updated Schema"](#).
- Most users should not need to use the ObjectFactory or import it. If you do need to import and use the ObjectFactory, then use a different package name for every XML Schema that you import; otherwise the different ObjectFactory classes conflict.
- The use of XML schema with elements that have `minOccurs="0"` and `nillable="true"` has special handling in JAXB. For more information, see [Section C.12, "Why do XML Schema with `xsd:string` Typed Elements Import as Type `JAXBElement`?"](#).
- The default element naming conventions for JAXB can cause XML schema containing the underscore character in XML-schema element names to fail to compile. For more information, see [Section D.7, "Why Does XML Schema with Underscores Fail JAXB Compilation?"](#).
- There are certain restrictions on the types and names of inputs for the Decision Service. For more information, see [Section D.8, "How Are Decision Service Input Output Element Types Restricted?"](#).
- The built-in dictionary includes support for the Java wrappers `Integer`, `Long`, `Short`, `Float`, `Double`, `BigDecimal`, and `BigInteger`. These types can appear in XML Fact Types.

## 3.3 Working with Java Facts

In Rules Designer, importing a Java Fact makes the Java classes and their methods become visible to Rules Designer. Rules Designer does not copy the Java code or bytecode into the data model or into the dictionary.

A Java fact type allows selected properties and methods of a Java class to be imported to the Rules Engine so that rules can access, create, modify, and delete instances of the Java class.

Importing a Java fact type allows the Rules Engine to access and use public attributes, public methods, and bean properties defined in a Java class (bean properties are preferable because they can be modified using the modify action).

### 3.3.1 How to Import Java Classes and Define Java Facts

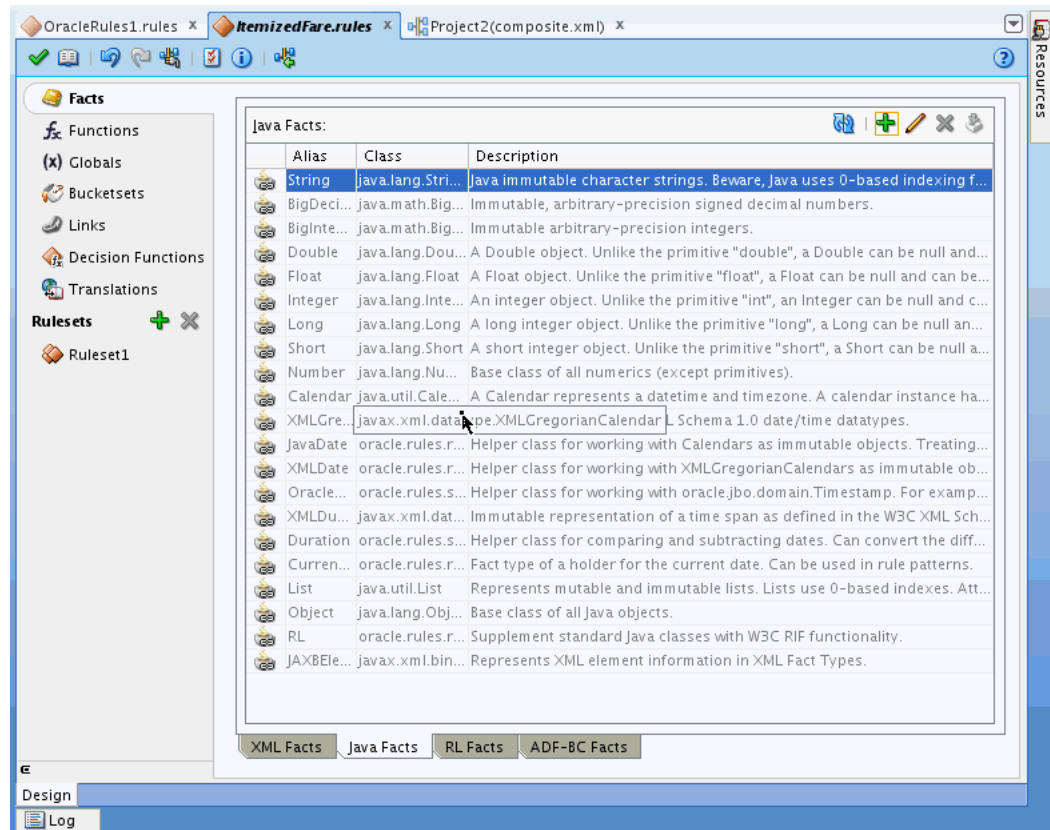
Before you can use Java Facts in rules and in Decision Tables, you must make the classes and packages that contain the Java Facts available to Rules Designer. To do this

you use Rules Designer to specify the classpath that contains the Java classes, and then you import the Java Facts.

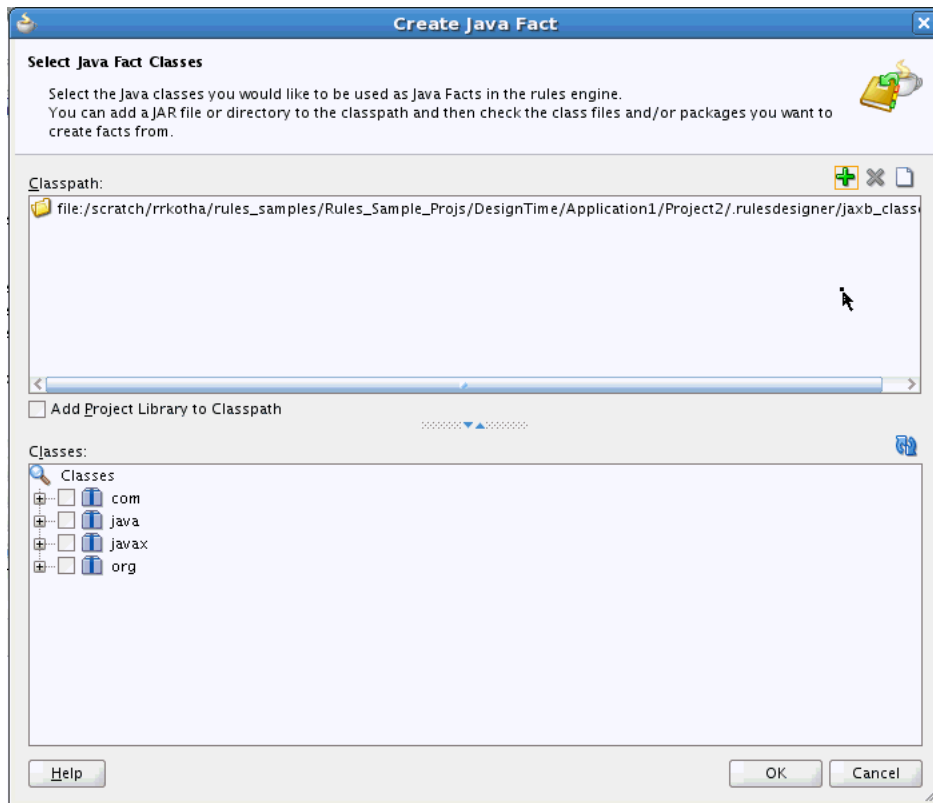
### To import and define Java Facts:

1. In Rules Designer, select the **Facts** navigation tab.
2. Select the **Java Facts** tab on the **Facts** navigation tab as shown in [Figure 3-5](#).

**Figure 3-5** The Java Facts Table in the Facts Navigation Tab



3. In the **Java Facts** tab, click **Create....** This displays the Create Java Fact dialog, as shown in [Figure 3-6](#).

**Figure 3–6 Adding a Java Fact**

4. In the Create Java Fact dialog, if the classpath that contains the classes you want to import is not shown in the **Classpath** area, then click **Add to Classpath**. This displays the Choose Directory/Jar dialog.

The default Rules Designer classpath includes three packages, `java`, `javax`, and `org`. These packages contain classes that Rules Designer lets you import from the Java runtime library (`rt.jar`). Rules Designer does not let you remove these classes from the **Classes** area (and the associated classpaths are not shown in the **Classpaths** area).

5. In the Choose Directory/Jar dialog, browse to select the classpath or jar file to add. By default, the output directory for the project is on the import classpath and any Java classes in the project should appear in the Classes importer. If they do not appear, execute the Build action for the project.
6. Click **Open**. This adds the classpath or jar file and updates the **Classes** area.
7. In the Create Java Fact dialog, in the **Classes** area select the packages and classes to import.
8. Click **OK**. This updates the Java Facts table in the **Java Facts** tab.

### 3.3.2 How to Display and Edit Java Facts

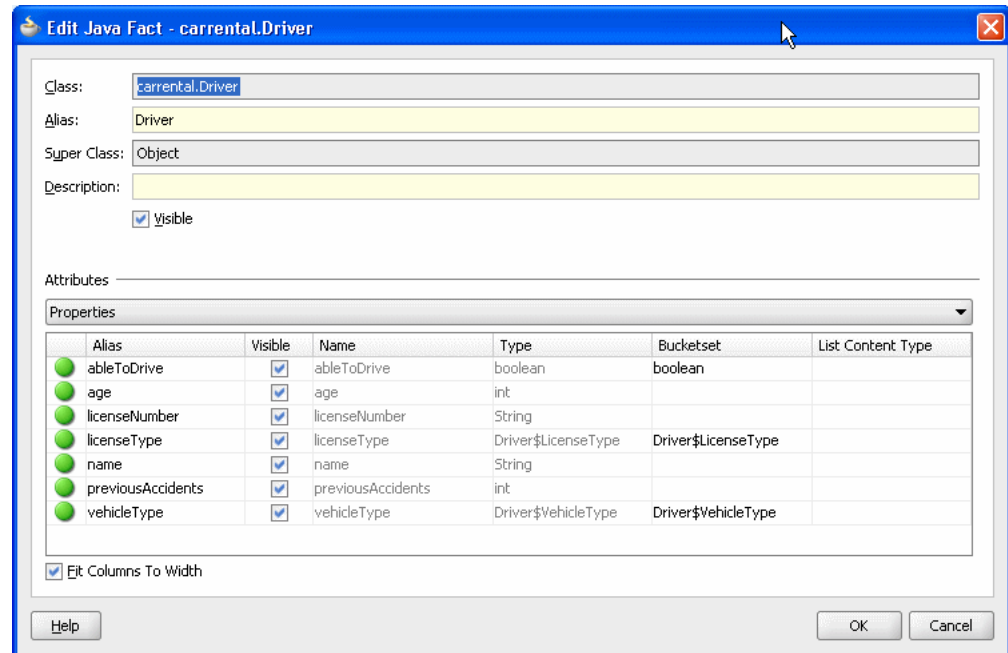
To display or edit Java Facts after you import the Java Facts, use the Edit Java Fact dialog.

#### To display and edit Java facts:

1. In Rules Designer, click the **Facts** navigation tab.

2. Select the **Java Facts** tab in the **Facts** navigation tab.
3. In the Java Facts table, double-click the Java Fact you want to edit. This displays the Edit Java Fact dialog as shown in [Figure 3–7](#).

**Figure 3–7** Edit Java Fact Dialog



The Edit Java Fact dialog includes the fields shown in [Table 3–2](#).

**Table 3–2** Edit Java Fact Dialog Fields

Field	Description
Class	Displays the Java Fact class for the source associated with the Java Fact.
Alias	Enter the Java Fact alias.
Super Class	Displays Java super class associated with this fact.
Description	Enter the Java Fact description.
Visible	Select to show the Java Fact in lists in Rules Designer.
Attributes area	Select the available class properties, constructors, methods, or fields associated with the Java class for the Java Fact act to display or edit.

### 3.3.3 What You Need to Know About Java Facts

When you define Java Facts you need to know the following:

- On Windows systems, you can use a backslash (\) or a slash (/) to specify the classpath in the **Classpath** area. Rules Designer accepts either path separator.
- Classes and interfaces that you use in Rules Designer must adhere to the following rules: If you are using a class or interface, only its superclass or one of its implemented interfaces may be made visible.

- When you specify the classpath you can specify a JAR file, a ZIP file, or a full path for a directory.
- When you specify a directory name for the classpath, the directory specifies the classpath that ends with the directory that contains the "root" package (the first package in the full package name). Thus, if the classpath specifies a directory, Rules Designer looks in that tree for directory names matching the package name structure.

For example, to import a class `cool.example.Test1` located in `c:\myprj\cool\example\Test1.class`, specify the classpath value, `c:\myprj`.

- You should reimport facts if you change the classes. After the reimport operation you may see validation warnings due to class changes. You should correct any validation warnings that may be caused by incompatible changes (for example, removing a property that is referenced by a rule).

## 3.4 Working with RL Facts

RL Facts are the only kind of facts that you can create directly and do not have an external source. All other types of Oracle Business Rules facts are imported. An RL Fact is similar to a relational database row or a JavaBean without methods. An RL Fact contains a list of properties of types available in the data model, either RL Fact, Java Fact, or primitive types. You can use an RL Fact to extend a Java application object model by providing virtual dynamic types.

For example:

```
IF customer spent $500 within past 3 months
    THEN customer is a Gold Customer
```

This rule might use a Java Fact to specify the customer data and also use an action that creates an RL Fact, Gold Customer. A rule might be defined to use a Gold Customer fact, as follows:

```
IF customer is a Gold customer
    THEN offer 10% discount
```

This rule uses the RL Fact named Gold Customer. This rule then infers, using the Gold Customer fact, that if a customer spent \$500 within the past 3 months, then the customer is eligible for a 10% discount. In addition rules could specify other ways that a customer becomes a Gold Customer.

For testing and prototyping with Rules Designer you can create RL Facts and use the RL Facts to write and test rules before you import a schema and switch to XML Facts (you might need to wait for an approved XML schema to be created or to be made available). Switching from RL Facts to corresponding XML Facts involves the following steps:

1. Delete the RL Facts (this action shows validation warnings in the rules or Decision Tables you created that use these RL Facts).
2. Import the XML Facts and give the facts and their properties aliases that match the names of the RL Facts and properties you deleted in step 1.
3. This process should remove the validation warnings if the XML Fact and property aliases and types match those of the RL Facts that you remove.

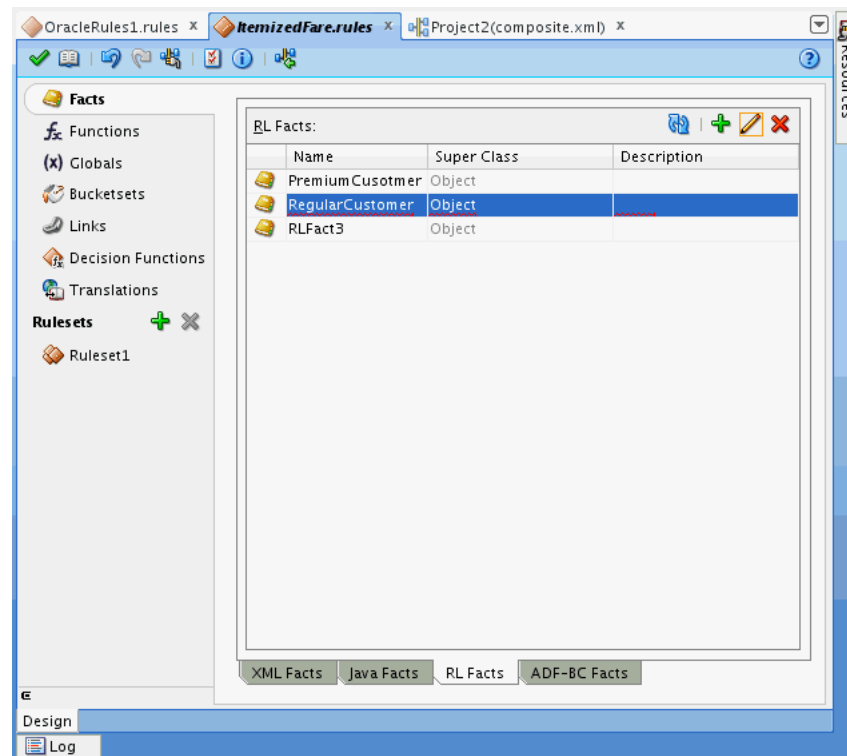
### 3.4.1 How to Define RL Facts

You add RL Facts from the **Facts** navigation tab.

**To define RL facts:**

1. In Rules Designer, select the **Facts** navigation tab.
2. Select the **RL Facts** tab in the **Facts** navigation tab as shown in [Figure 3–8](#).

**Figure 3–8** *RL Facts Tab in Rules Designer*



3. In the **RL Facts** tab, click **Create**.
4. In the **RL Facts** table, in the **Name** field, enter the name for the RL Fact or accept the default name.
5. In the **RL Facts** table, in the **Description** field, enter a description or accept the default, no description.

### 3.4.2 How to Display and Edit RL Facts and Add RL Fact Properties

You add properties to RL Facts using the Edit RL Facts dialog.

**To display and edit RL facts and add RL fact properties:**

1. In Rules Designer, select the **Facts** navigation tab.
2. In the **RL Facts** tab, double-click the icon for the RL Fact to display or edit the fact. This displays the Edit RL Fact dialog, as shown in [Figure 3–9](#).

**Figure 3–9 Edit RL Fact Dialog**

**Edit RL Fact - RLFact2**

Name: RegularCustomer

Super Class: Object

Description:

Properties: + X

Name	Type	Bucketset	Initial Value	List Content Type
Income				
Property2				

Fit Columns To Width

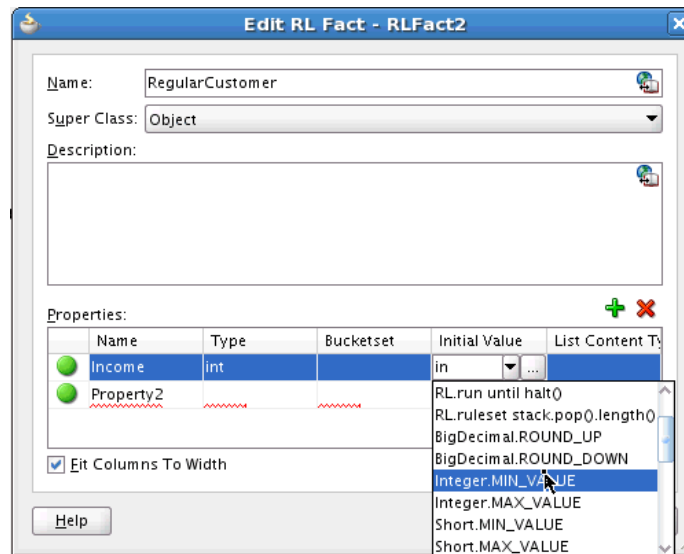
Help OK Cancel

3. To add RL Fact properties, on the Edit RL Fact dialog in the **Properties** area, click **Create**.
  - a. In the **Name** field, enter the property name.
  - b. In the **Type** field, select a type from the list or enter a property type.
  - c. To associate a bucketset with the property, from the list in the **Bucketset** field, select a bucketset.
  - d. To associate an initial value with the property enter a value in the **Initial Value** field.
4. Add additional properties by repeating these steps, as required.
5. Click **OK**.

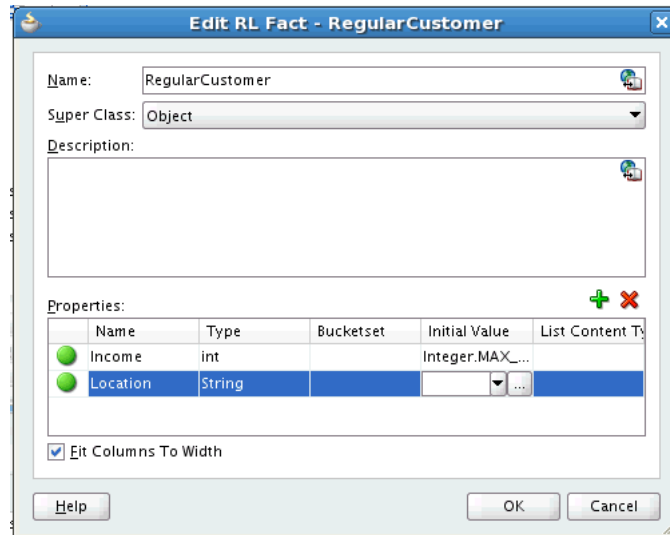
### 3.4.3 What You Need to Know About RL Facts

When you add properties to RL Facts using the Edit RL Facts dialog, in the **Properties** area the **Initial Value** field provides a list of possible values as shown in [Figure 3–10](#).



**Figure 3–10** Setting RL Fact Property Initial Value

When you are working with some fields in Rules Designer, the initial values list or other lists may be empty as shown in [Figure 3–11](#). In this case the list is an empty box. Thus, when Rules Designer does not find options to assist you in entering values, you must supply a value directly in the text entry area or click the **Expression Builder** icon to display the expression builder dialog.

**Figure 3–11** RL Fact Empty List Options for Initial Value Field

### 3.5 Working with ADF Business Components Facts

ADF Business Components Facts allow you to use ADF Business Components as Facts in rules and in Decision Tables. By using ADF Business Components Facts you can assert view object graphs representing the business objects upon which rules should be based, and let Oracle Business Rules deal with the complexities of managing the relationships between the various related view objects in the view object graph.

For more information, see [Chapter 10, "Working with Oracle Business Rules and ADF Business Components"](#).

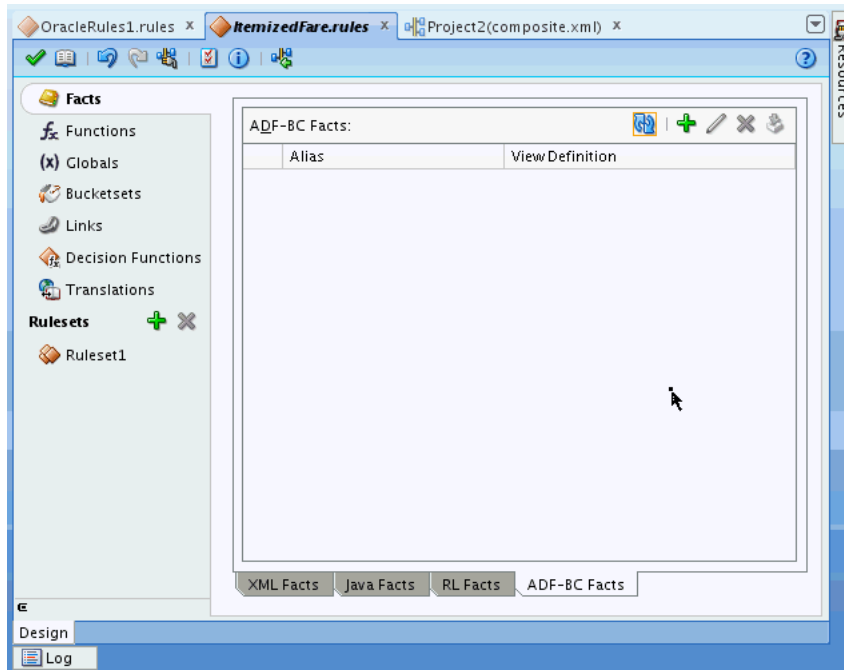
### 3.5.1 How to Import and Define ADF Business Components Facts

When an ADF Business Components view object is imported, an ADF Business Components fact type is created which has a property corresponding to each attribute of the view object.

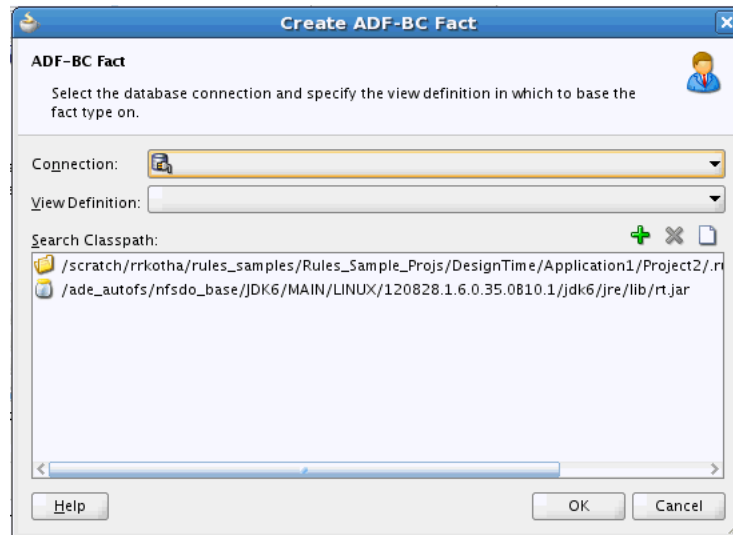
#### To add ADF Business Components facts:

1. Click the **Facts** navigation tab and select the **ADF-BC Facts** tab. This displays the **ADF-BC Facts** table, as shown in [Figure 3–12](#).

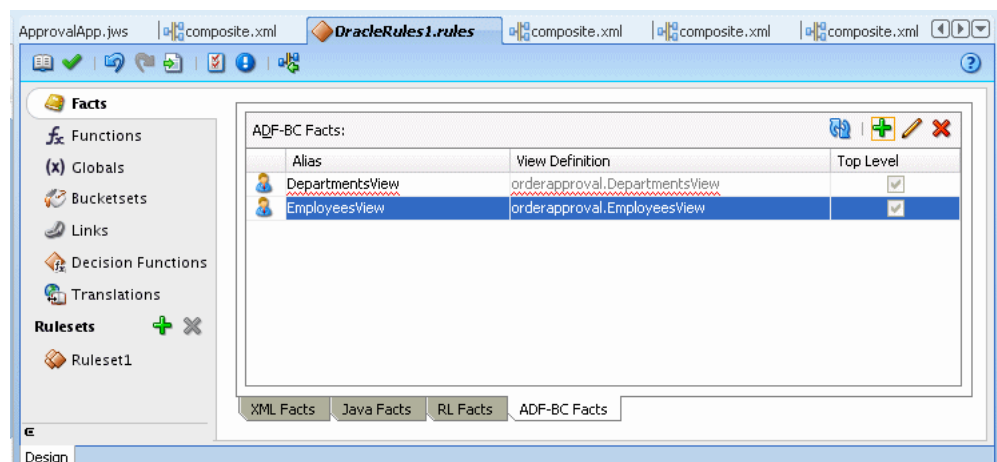
**Figure 3–12 ADF Business Components Facts Tab**



2. Click **Create....** This displays the ADF Business Components Fact dialog, as shown in [Figure 3–13](#).

**Figure 3–13 Create ADF-BC Fact Dialog**

3. In the **Connection** field, from the list, select the connection which your ADF Business Components objects use. The **Search Classpath** area shows a list of classpaths. For more information, see [Section 3.5.2, "What You Need to Know About ADF Business Components Fact Classpaths"](#).
4. In the **View Definition** field, select the name of the view object to import.
5. Click **OK**. This displays the Facts navigation tab, as shown in [Figure 3–14](#). Note that the imported fact includes a validation warning. For information on how to remove this validation warning, see [Section 3.5.3, "What You Need to Know About ADF Business Components Circular References"](#).

**Figure 3–14 ADF Business Components Facts in Rules Designer**

### 3.5.2 What You Need to Know About ADF Business Components Fact Classpaths

In the classpath list shown in the **Search Classpath** area in the Create ADF Business Components Fact dialog one of the listed classpaths allows you to see the view object definitions available in your project. In this dialog you only need to click **Add to Classpath** when you need to use a classpath that is not available to your project (this case should be very rare).

### 3.5.3 What You Need to Know About ADF Business Components Circular References

ADF Business Components Facts can include a circular reference, as shown in [Figure 3–14](#). When this warning is shown in the Business Rule validation log you need to manually resolve the circular reference. To do this you must deselect the **Visible** checkbox for one of the properties that is involved in the circular reference.

### 3.5.4 What You Need to Know About ADF Business Components Facts

Each ADF Business Components fact type contains a property named `ViewRowImpl` that references the `oracle.jbo.Row` instance that the fact instance represents and a property named `key_values` which points to an `oracle.rules.sdk2.decisionpoint.KeyChain` object that may be used to retrieve the set of key-values for this row and its parent rows.

When working with ADF Business Components Facts you should know the following:

- Relationships between view object definitions are determined by introspection of attributes on the View Definition, specifically, those attributes which are View Link Accessors.

The ADF Business Components fact type importer correctly determines which relationships are 1-to-1 and which are 1-to-many, and generates definitions in the dictionary accordingly. For 1-to-many relationships the type of the property generated is a `List`, which contains facts of the indicated type at runtime.

- It is not possible to use ADF Business Components fact types which have cyclic type dependencies. These cycles must be broken by the deselecting the **Visible** checkbox for at least one property involved in the cycle.
- ADF Business Components fact types are not Java fact types and do not allow invoking methods on any explicitly created implementation classes for the view object.

If you need to call such methods then add the view object implementation to the dictionary as a Java fact type instead of as an ADF Business Components fact type. In this case, all getters and setters and other methods become available but the trade-off is that related view objects become inaccessible and, should related view object access be required, these relationships must be explicitly managed.

- Internally, ADF Business Components fact types are instances of RL fact types.

Thus, you cannot assert ADF Business Components view object instances directly to a Rule Session, but must instead use the helper methods provided in the `MetadataHelper` and `ADFBCFactTypeHelper` classes. For more information, see *Oracle Fusion Middleware Java API Reference for Oracle Business Rules*.

## 3.6 Working with Bucketsets

You can create a bucketset to define a list of values or a list of value ranges to limit the acceptable set of values for a fact or a property of a fact in Oracle Business Rules. You can define a bucketset as a **Global Bucketset** that allows reuse, where a bucketset is named and stored in the data model, or as a **Local Bucketset** that is specified when you define a Decision Table and only applies to one condition expression. For more information on using a local bucketset, see [Section 5.2.2, "How to Add Condition Rows to a Decision Table"](#).

You can use Bucketsets for the following:

- You can associate fact type properties with bucketsets. This allows you to limit the acceptable set of values for a property of a fact. For more information, see [Section 3.7.1, "How to Associate a Bucketset with a Fact Property"](#).
- In a Decision Table a bucketset defines a list of values or value ranges in the condition expressions that are part of the Decision Table. The bucketset values or ranges determine, for each condition expression in a Decision Table, that it has two or more possibilities. Using a bucketset each possibility in a condition expression is divided into groups or ranges where a cell specifies one **Bucket** of values from the bucketset (or possibly multiple buckets of values per cell). For example, if a bucketset is defined for colors, then the buckets could include a list of strings: "blue", "red", and "orange". A bucketset that includes integers could have three buckets, less than 1, 1 to 10, and greater than 10. For more information, see [Section 5.2.2, "How to Add Condition Rows to a Decision Table"](#).
- You can associate globals, functions, and function arguments with bucketsets. Associating a bucketset with a global allows for design-time validation that an assigned value is limited to the values specified in the bucketset. Associating a bucketset with a function argument validates that the function is only called with values in the bucketset. Using bucketsets in this manner allows Rules Designer to report validation warnings for global values and function arguments that are assigned or passed a constant argument value that is not allowed. Associating a bucketset with a function automatically sets a Decision Table condition row to use that bucketset when the function is used as the expression for that condition row. This type of bucketset validation is "weak" in the sense that only design-time constant values are validated. No runtime checks are applied based on the globals or function arguments associated with bucketsets. For more information, see [Section 3.7.2, "How to Associate a Bucketset with Functions or Function Arguments"](#).
- In addition to design-time validation you can use an LOV bucketset to provide options that are displayed in lists when entering expressions in IF/THEN rule tests and actions. For more information, see [Section 4.11.3, "How to Use Bucketsets to Provide Options for Test Expressions"](#).

There are three forms for bucketsets:

- LOV: Defined by a list of values (see [Section 3.6.1, "How to Define a List of Values Global Bucketset"](#)).
- Range: Defined by a list of value ranges, defined by the range endpoints (see [Section 3.6.2, "How to Define a List of Ranges Global Bucketset"](#)).
- Enum: Defined by a list of enumerated types that is imported from either of:
  - XML types (see [Section 3.6.3, "How to Define an Enumerated Type \(Enum\) Bucketset from XML Types"](#)).
  - Java facts (see [Section 3.6.4, "How to Define an Enumerated Type \(Enum\) Bucketset from Java Types"](#)).

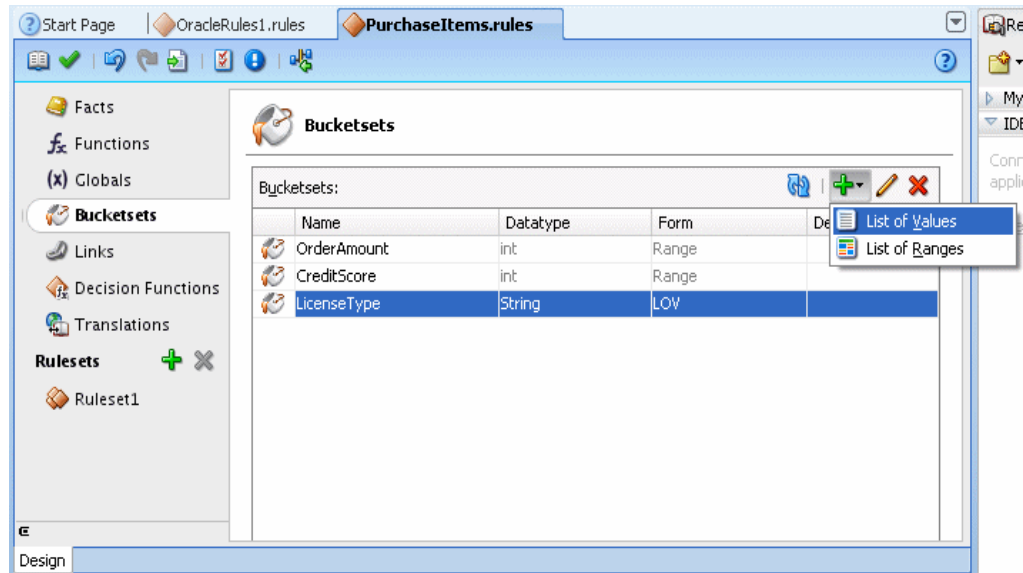
### 3.6.1 How to Define a List of Values Global Bucketset

A list of values bucketset lets you specify the type and the list of buckets for the bucketset.

For more information, see [Section 3.6.5, "What You Need to Know About List of Values Bucketsets"](#).

**To define a list of values (LOV) global bucketset:**

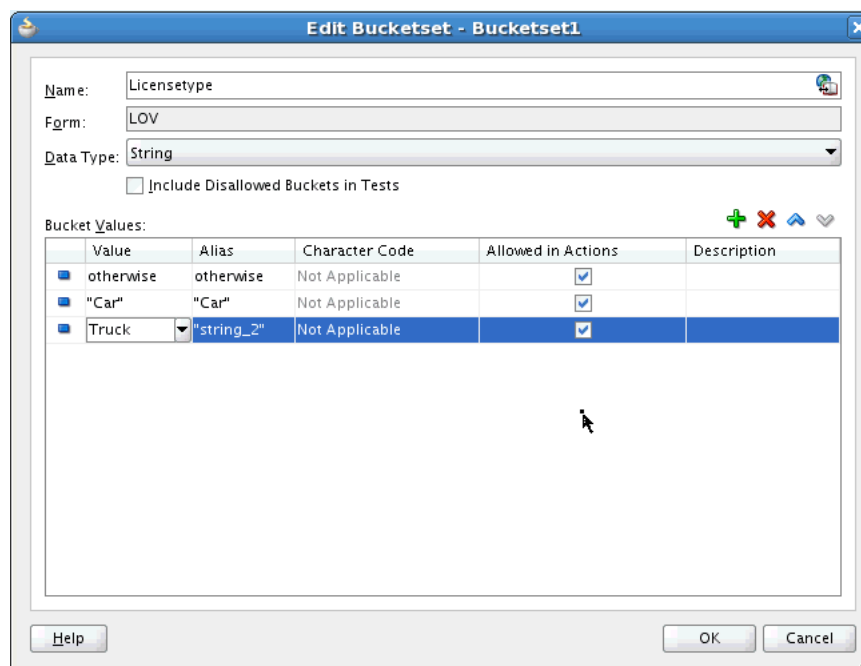
1. From Rules Designer select the **Bucketsets** navigation tab.
2. From the list next to the **Create BucketSet...** icon, select **List of Values**, as shown in [Figure 3–15](#).

**Figure 3–15 Adding a List of Values Bucketset**

3. Double-click the bucket icon for the bucket. This displays the Edit Bucketset dialog.
4. In the Edit Bucketset dialog, enter the bucketset name in the **Name** column.  
Ensure that the bucketset name is not the same as the as a fact alias, because this would result in a validation errors as the following:  
RUL-05006: The fact type "Rating" has the same alias as an unrelated bucketset.
5. In the **Data Type** column select a data type from list.  
For example, select **String** from the list.
6. Click the **Create** icon to add a value.
7. For each bucket that you add, do the following:
  - In the **Value** field, enter a value. Note that for String type values in an LOV bucket, you can select the entire string with three clicks. This allows you to enter the string and Rules Designer adds the same alias without quotation marks, as shown in [Figure 3–16](#).
  - In the **Alias** field, enter an alias.  
For more information on specifying aliases, see [Section 3.6.2, "How to Define a List of Ranges Global Bucketset."](#)
  - In the **Allowed in Actions** field, select this if the value is an allowable value.  
For more information on the **Allowed in Actions** field and the **Include Disallowed Buckets in Tests** field, see [Section 3.6.7, "What You Need to Know About Bucketset Allowed in Actions Option"](#).
  - In the **Description** field, enter a description.

8. Add additional values by clicking the **Create** icon as needed for the bucketset, as shown in [Figure 3-16](#).

**Figure 3-16 Create List of Values Bucketset**



9. On the Edit Bucketset window, click **OK**.

You can control rule ordering in a Decision Table by changing the relative position of the buckets in an LOV bucketset associated with a condition expression in a Decision Table.

#### To change the order of buckets in a list of values bucketset:

1. In the Edit Bucketset dialog for the bucketset, select the bucket you want to reorder.
2. Click the **Move Down** icon to reorder the bucket down.
3. Click the **Move Up** icon to reorder the bucket up.
4. Click **OK**.

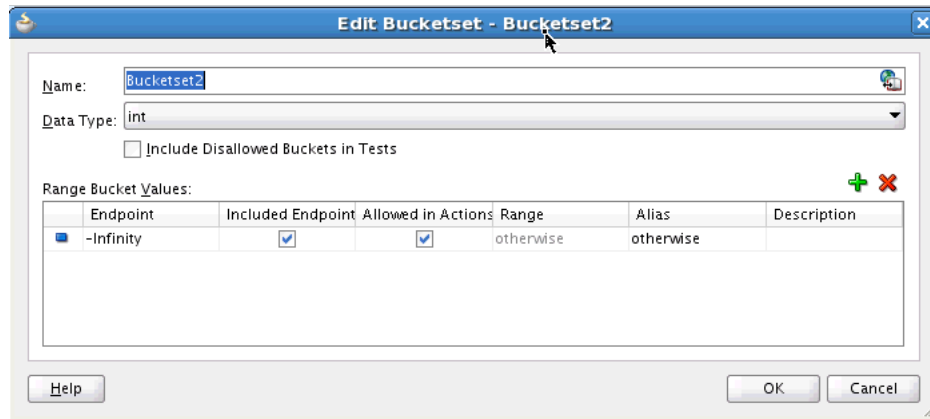
### 3.6.2 How to Define a List of Ranges Global Bucketset

A list of ranges bucketset lets you specify the type and the endpoints for buckets in the bucketset.

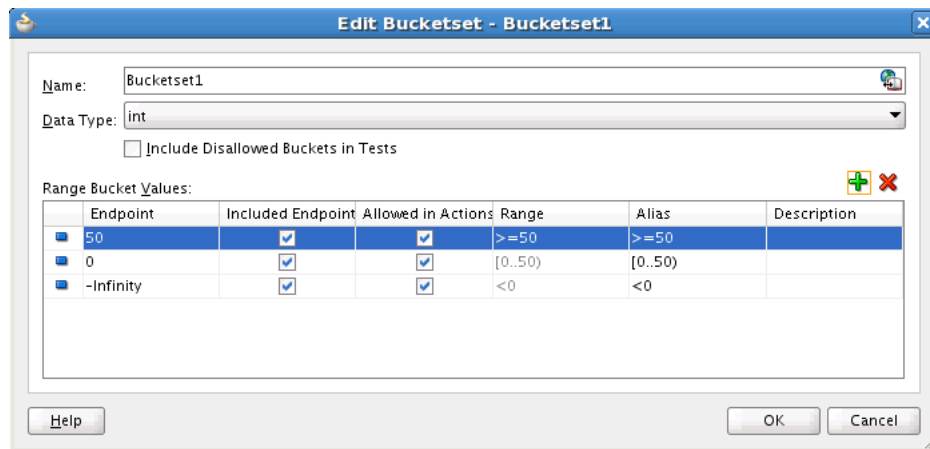
For more information, see [Section 3.6.6, "What You Need to Know About Range Bucketsets"](#).

#### To define a list of ranges (range) global bucketset:

1. From Rules Designer select the **Bucketsets** navigation tab.
2. From the list next to the **Create BucketSet...** icon, select **List of Ranges**.
3. Double-click in the **Data Type** field. This displays the Edit Bucketset dialog, as shown in [Figure 3-17](#).

**Figure 3–17 Edit Bucketset: List of Ranges**

4. In the Edit Bucketset dialog, enter the bucketset name in the **Name** field.
5. In the Edit Bucketset dialog, in the **Data Type** field, from the list, select the appropriate data type for the bucketset.  
In this example, select **int**.
6. Click the **Add Bucket** icon repeatedly to add the number of buckets you need in the bucketset as shown in [Figure 3–18](#).

**Figure 3–18 Edit Bucketset: Adding Required Buckets**

In these steps you add three buckets. You start with the default values, as shown in [Figure 3–18](#). After changing the default buckets, the buckets have the following values:

- greater than 1000
- between 500 and 1000, inclusive
- less than 500

Rules Designer added the buckets with the default values of 50 and 0 and a negative Infinity (-Infinity) bucket.

7. Starting at the first or top bucket, in the **Endpoint** field, double-click the default value and enter the top value bucket endpoint, and press **Enter**.

In this example, enter 1000 for the first bucket.



8. In the **Included Endpoint** field, select the checkbox as appropriate to include or exclude the bucket endpoint.

In this example, you can leave this checkbox checked to include the bucket endpoint.

9. In the **Allowed in Actions** field select the checkbox as appropriate to include the bucket in the bucketset allowable values.

For more information on the **Allowed in Actions** field and the **Include Disallowed Buckets in Tests** field, see [Section 3.6.7, "What You Need to Know About Bucketset Allowed in Actions Option"](#).

10. Optionally, in the **Alias** field double-click the default value and enter the desired bucket alias, and press **Enter**.

The alias appears in Decision Tables that use this bucketset. Use an alias to give a more meaningful name to the bucket than the default value (the range-based Range value).

Please note that most names and aliases in Oracle Business Rules allow only letters, numbers, embedded single spaces, and the characters \$, \_, ' , . , - , / , and : . However, bucket aliases allow additional characters, such as [0..1]. If a bucket alias contains such additional characters, then you cannot refer to the bucket by the alias in the action cells in a Decision Table. In these cases, you can use the bucket name, which is also known as the bucket value.

The Range field is read-only: it clearly identifies the actual range associated with the bucket regardless of the Alias value. For more information, see [Section 3.6.6, "What You Need to Know About Range Bucketsets"](#).

11. Moving down the list of buckets, for each subsequent bucket, repeat from Step 7. For the second bucket, enter the endpoint value 500.

[Figure 3–19](#) shows the completed bucketset.

**Figure 3–19 Edit Bucketset: Completed Range Buckets**

Endpoint	Included Endpoint	Allowed in Actions	Range	Alias	Description
1000	<input checked="" type="checkbox"/>	<input checked="" type="checkbox"/>	>=1000	>=1000	
500	<input checked="" type="checkbox"/>	<input checked="" type="checkbox"/>	[500..1000)	[500..1000)	
-Infinity	<input checked="" type="checkbox"/>	<input checked="" type="checkbox"/>	<500	<500	

12. In the Edit Bucketset dialog, click **OK**.

### 3.6.3 How to Define an Enumerated Type (Enum) Bucketset from XML Types

When you import an XML schema, if the XSD contains enumeration values Rules Designer automatically creates an enumerated type bucketset for each enumeration.

Although enumerated type bucketsets are read-only, you can change the order of buckets.

For more information, see [Section 3.2.4, "What You Need to Know About XML Facts"](#).

### To define an enumerated type (enum) bucketset from XML types:

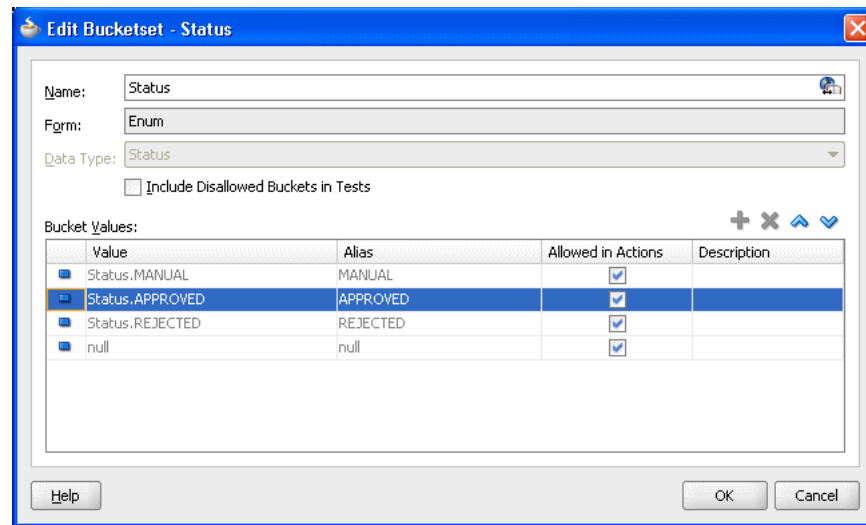
1. Obtain an XSD with the desired enumerations.

[Example 3–2](#) shows the `order.xsd` schema file which contains the enumeration `Status`.

#### **Example 3–2 Order.xsd Schema**

```
<?xml version="1.0" ?>
<schema attributeFormDefault="qualified" elementFormDefault="qualified"
  targetNamespace="http://example.com/ns/customerorder"
  xmlns:tns="http://example.com/ns/customerorder"
  xmlns="http://www.w3.org/2001/XMLSchema">
  <element name="CustomerOrder">
    <complexType>
      <sequence>
        <element name="name" type="string" />
        <element name="creditScore" type="int" />
        <element name="annualSpending" type="double" />
        <element name="value" type="string" />
        <element name="order" type="double" />
      </sequence>
    </complexType>
  </element>
  <element name="OrderApproval">
    <complexType>
      <sequence>
        <element name="status" type="tns:Status"/>
      </sequence>
    </complexType>
  </element>
  <simpleType name="Status">
    <restriction base="string">
      <enumeration value="manual"/>
      <enumeration value="approved"/>
      <enumeration value="rejected"/>
    </restriction>
  </simpleType>
</schema>
```

2. Open a dictionary in Rules Designer and create XML facts using the specified schema that contains the enumeration. For more information, see [Section 3.2, "Working with XML Facts"](#).
3. Click the **Bucketsets** navigation tab and select the Enum bucketset to see the bucketset, as shown in [Figure 3–20](#). In [Figure 3–20](#), notice that the imported `Status` enumeration values shown in [Example 3–2](#) are imported as buckets with the XSD-specified values.

**Figure 3–20 Bucketset Showing the Form Enum with Imported Values**

You can control rule ordering in a Decision Table by changing the relative position of the buckets in an enum bucketset associated with a condition expression in a Decision Table.

**To change the order of buckets in an enum bucketset:**

1. In the Edit Bucketset dialog for the bucketset, select the bucket you want to reorder.
2. Click the **Move Down** icon to reorder the bucket down.
3. Click the **Move Up** icon to reorder the bucket up.
4. Click **OK**.

### 3.6.4 How to Define an Enumerated Type (Enum) Bucketset from Java Types

When you import a Java enum, Rules Designer automatically creates an enumerated type bucketset for each Java enum. Although enumerated type bucketsets are read-only, you can change the order of buckets.

**To define an enumerated type (enum) bucketset from Java facts:**

1. Create or obtain the Java class with the desired enumerations.

[Example 3–3](#) shows the `RejectPurchaseItem.java` class which contains enumeration `OrderSize`.

**Example 3–3 Java Fact with enum OrderSize**

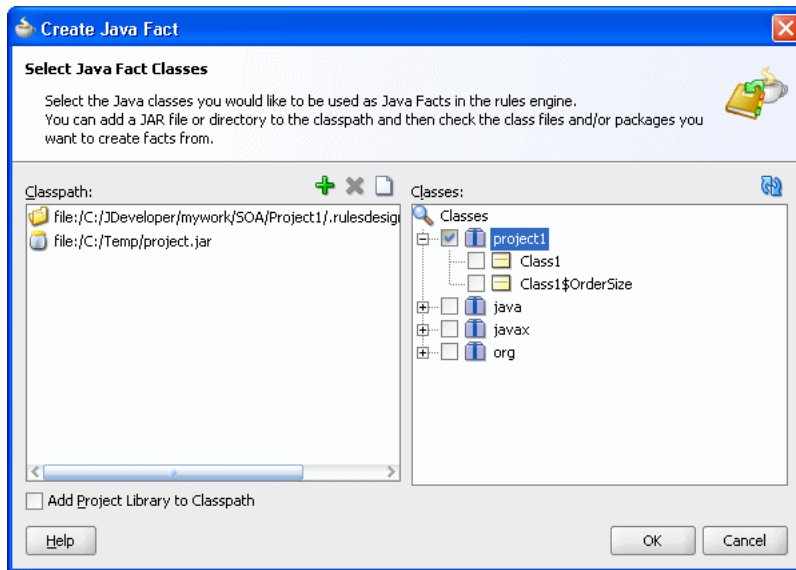
```
package com.example;

public class Class1
{
    public enum OrderSize { SMALL, MEDIUM, LARGE };
    public Class1()
    {
    }
}
```

2. In Rules Designer open a dictionary and create a Java Fact using the Java class. For more information, see [Section 3.3, "Working with Java Facts"](#).

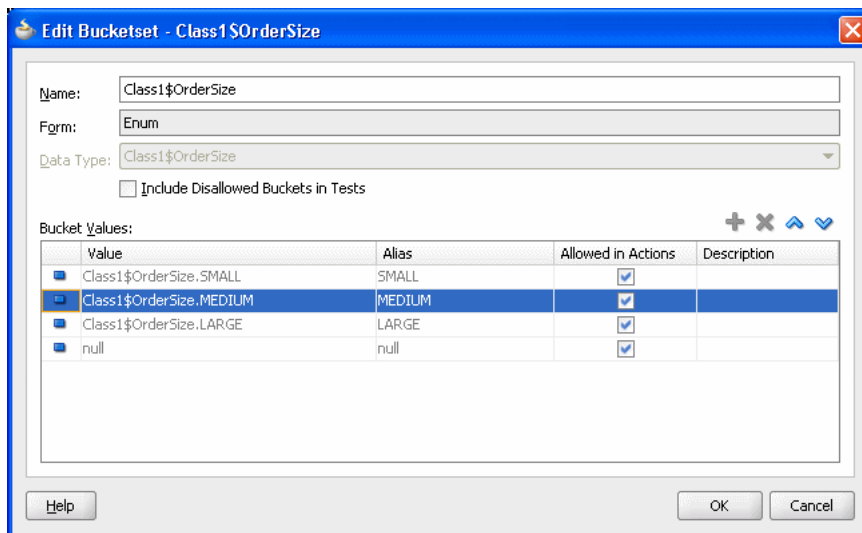
Figure 3–21 shows a how to create a Java fact for the Java enumeration `Class1$OrderSize`.

**Figure 3–21** Creating a Java Fact



3. In Rules Designer click the **Bucketsets** navigation tab and select the Enum bucketset, as shown in Figure 3–22. Note that the `Class1$OrderSize` enumeration from the enumeration in Example 3–3 is now a bucketset with the Java enum-specified values.

**Figure 3–22** Edit Bucketset Dialog for Java Enum



You can control rule ordering in a Decision Table by changing the relative position of the buckets in an enum bucketset associated with a condition expression in a Decision Table.

**To change the order of buckets in an enumerated type (enum) bucketset:**

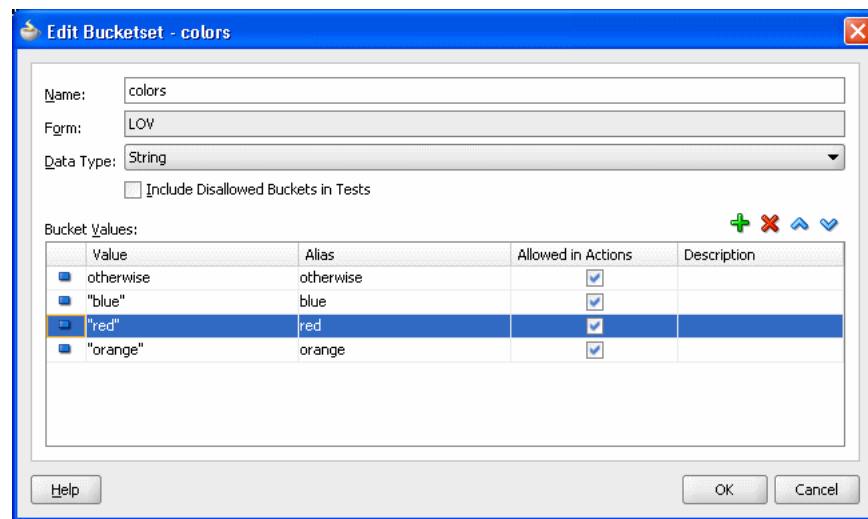
1. In the Edit Bucketset dialog for the bucketset, select the bucket you want to reorder.
2. Click the **Move Down** icon to reorder the bucket down.
3. Click the **Move Up** icon to reorder the bucket up.
4. Click **OK**.

### 3.6.5 What You Need to Know About List of Values Bucketsets

In a Decision Table the order of the buckets in a bucketset associated with a condition expression determines the order of the condition cells, and thus the order of the rules. You can control rule ordering in a Decision Table by changing the relative position of the buckets in a list of values bucketset associated with a condition expression; however, you cannot reorder range buckets.

Figure 3–23 shows a bucketset definition in Rules Designer for a bucketset named colors using a list of values.

**Figure 3–23** Bucketset Definition Using List of Values



As shown in Figure 3–23, by default with a List of Values bucketset there is a value otherwise included with the list of values (LOV). This value, otherwise, is distinct from all other values and matches all values of the type that have no other bucket. Thus, with otherwise in the list of values a condition expression that uses the bucketset can handle every value and provides a match for every value of the specified type, where a match is either a defined value or the otherwise bucket. The otherwise value cannot be removed from an LOV bucketset but it can be excluded by clearing the **Allowed in Actions** checkbox (when otherwise is excluded an attempt to assign any value that is not in the list of buckets in the bucketset causes a validation warning).

Table 3–3 shows the bucketset values that Rules Designer supports for LOV bucketsets.

**Table 3–3** Supported Types for LOV Bucketsets

Type	Description
Java primitive types	This includes int, double, boolean, char, byte, short, long, and float

**Table 3–3 (Cont.) Supported Types for LOV Bucketsets**

Type	Description
String	Contains String types
Calendar	Contains Calendar types in the current locale

**Note:** You are not required to specify an LOV bucketset when you use a boolean type in a Decision Table. For boolean types, Oracle Business Rules provides built-in buckets for the possible values (`true` and `false`).

### 3.6.6 What You Need to Know About Range Bucketsets

When you add a bucket to a List of Ranges bucketset, the value is calculated based on the currently selected bucket value and the next highest bucket value. When you change the endpoint value the value is automatically sorted in the bucketset; thus, it does not matter where a bucket is added. However, it is possible for Rules Designer to not have spaces between the current bucketset endpoint value and the endpoint value. In this case, Rules Designer shows a validation warning of the following form:

RUL-05849: Bucketset has duplicate bucket value "4999"

To correct this problem you must modify bucket endpoints to remove the duplicate bucket.

Figure 3–24 shows the Edit Bucketset window for a bucketset with an integer, `int`, range.

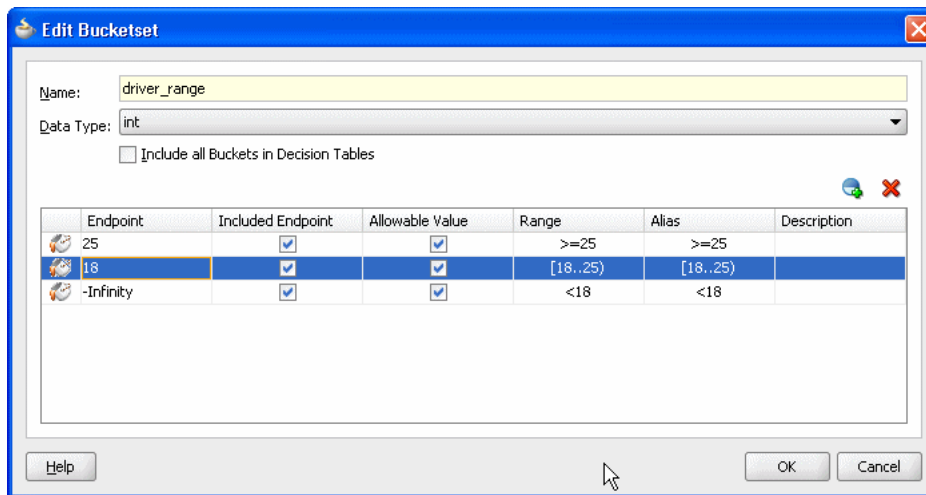
**Figure 3–24 Bucketset Definition Using List of Ranges and Three Endpoints**

Table 3–4 shows the types Rules Designer supports for Range buckets.

**Table 3–4 Supported Types for Range Buckets**

Type	Description
Selected primitive types	This includes: <code>int</code> , <code>double</code> , <code>short</code> , <code>long</code> , and <code>float</code>
Calendar	Contains Calendar types in the current locale

Note the following conventions for the Range field:

- Logical operator: specifies a range with respect to positive or negative infinity. For example, " $\geq 25$ " means "from 25 to positive infinity" and " $< 18$ " means from negative infinity up to but not including 18.
- Square bracket "[": specifies a range that includes this end point value. For example, "[18 . 25)" means "from 18 up to but not including 25".
- Round bracket ")": specifies a range that excludes this end point value. For example, "(18 . . 25]" means "over 18, not including 18, up to and including 25".

### 3.6.7 What You Need to Know About Bucketset Allowed in Actions Option

When you define buckets in a bucketset you might define some buckets corresponding to non-permissible values. For example, in a bucketset for driver ages you would typically not allow a bucket that contains values less than 0. Thus, when a fact with driver data includes an age property associated with a driver ages bucketset, then you should not be able to create or modify a fact that has the age property set to a value such as -1. In a bucketset you select **Allowed in Actions** for valid buckets and deselect this option for invalid buckets.

The bucketset option **Include Disallowed Buckets in Tests** allows you to include all the buckets, whether **Allowed in Actions** is selected or not, in Decision Table conditions and in rule tests. By including all buckets you can explicitly test for illegal values. Using the option **Include Disallowed Buckets in Tests** you can handle two possible cases:

1. The input data for the Oracle Business Rules Engine is clean and does not contain invalid data (such as a negative age). In this case, you should deselect the **Include Disallowed Buckets in Tests**. Note: the reason you do not want to make  $\text{age} < 0$  an **Allowed in Actions** is this provides design time validation warnings if you try to create an action that uses an invalid value, such as the following: `modify(driver, age: -1)`. For more information, see [Section 4.11, "Using Bucketsets as Constraints for Options Values in Rules"](#).
2. You want to consider excluded buckets in rule tests and in Decision Tables. In this case, you should select **Include Disallowed Buckets in Tests**. This is useful when the input data for the Oracle Business Rules Engine may not be clean and may contain invalid data (for example an invalid negative age). A Decision Table that provides actions for all bucketsets could include cases for excluded buckets and provide an appropriate action, such as asserting an error fact. To handle this you could either select the **Allowed in Actions** field for every bucket in the bucketset, or, leave the **Allowed in Actions** field configured as is and select the **Include Disallowed Buckets in Tests** field. Using the **Include Disallowed Buckets in Tests** field is not only convenient, you do not need to reconfigure every bucket, it also preserves the configuration of **Allowed in Actions** so that you can easily reuse this bucketset to handle the first case (when you deselect **Include Disallowed Buckets in Tests**).

### 3.6.8 What You Need to Know About Bucket Values

When you enter a bucket value in a bucketset, the value you supply must be valid for the type specified for the bucketset. If the value you enter is not valid for the bucketset type, Rules Designer makes the value you supply a string by adding quotation marks. Adding quotation marks is the only way to make a legal literal when the user provided data is not appropriate for the specified type. For example, if you add an int type LOV bucketset, and then supply a value 2.2 to a bucket, Rules Designer shows a warning such as the following:

RUL-05833: Invalid characters "2.2" in bucket value

To fix this problem either enter a valid value for the bucket value, for example in this case the value 2, or change the type of the bucketset.

For an additional example, when you enter a value for a bucket, for example if you enter a bucket value with bucketset with data type short and add a bucket with the value 999999, Rules Designer assigns this the value "999999". The maximum value for a short is 32767. In this case you see a warning related to the bucket value, similar to the previous example, because a String is not a valid bucket value for a bucketset with data type short. The solution to this is to enter appropriate values for all buckets (in this example, enter a value less than or equal to 32767).

## 3.7 Associating a Bucketset with Business Terms

After you define a global bucketset you can associate parts of the data model with the global bucketset (if their types are compatible). In this way, condition cells in the **Conditions** area can automatically be assigned a bucketset when you define a Decision Table. Also, when a bucketset is associated with a business term, Oracle Business Rules uses the buckets that you define as constraints for the values for expressions for the business terms in rules.

You can associate the following four kinds of business term with a bucketset:

- Fact Property
- Function Result
- Function Argument
- Global Value

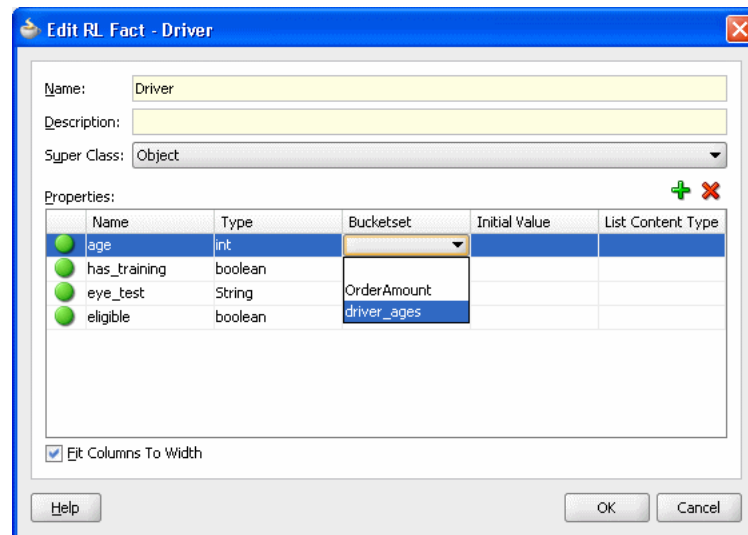
### 3.7.1 How to Associate a Bucketset with a Fact Property

To prepare for creating Decision Tables, you can associate a global bucketset with fact properties in the data model.

**To associate a bucketset with a fact property:**

1. From Rules Designer, select the **Facts** navigation tab.
2. Select the fact type to edit and click the **Edit** icon. This displays the appropriate Edit Fact dialog for the fact type you select.
3. In the Properties table, under **Bucketset**, select the cell for the appropriate fact property and from the list select the bucketset you want to associate with the property. For example, see [Figure 3-25](#).



**Figure 3–25 Defining a Bucketset for a Property**


4. On the Edit Fact page, click **OK**.

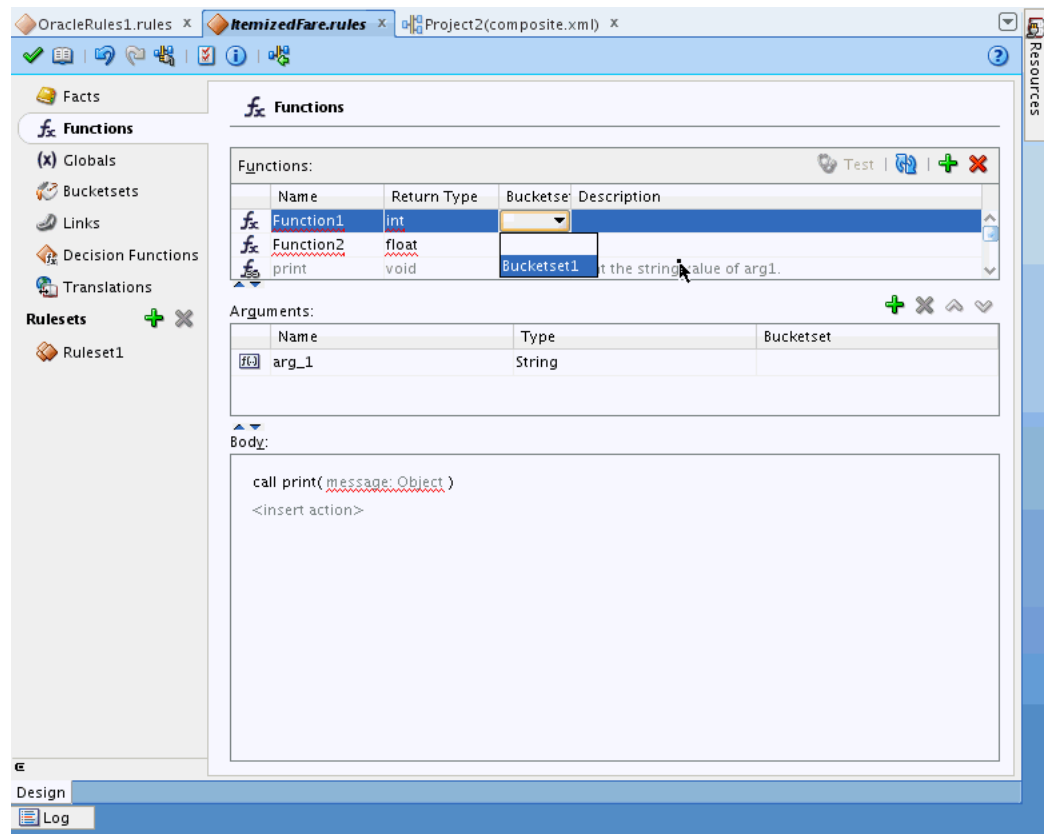
### 3.7.2 How to Associate a Bucketset with Functions or Function Arguments

To prepare for creating Decision Tables you can associate a global bucketset with functions in the data model.

#### To associate a bucketset with a function return value:

1. From Rules Designer, select the **Functions** tab.
2. Select the function to edit. This shows the function arguments and the function body for the specified function.
3. In the Functions table, under **Bucketset**, select the cell and from the list select the bucketset you want to use. For example, see [Figure 3–26](#).

**Figure 3–26 Defining a Bucketset for a Function Return Value**



**To associate a bucketset with a function argument:**

1. From Rules Designer, select the **Functions** navigation tab.
2. Select the function to edit. This shows the function arguments and the function body for the specified function.
3. In the Functions table, in the **Arguments** area select the appropriate argument.
4. For the specified argument, under **Bucketset**, select the cell and from the list select the bucketset you want to use.

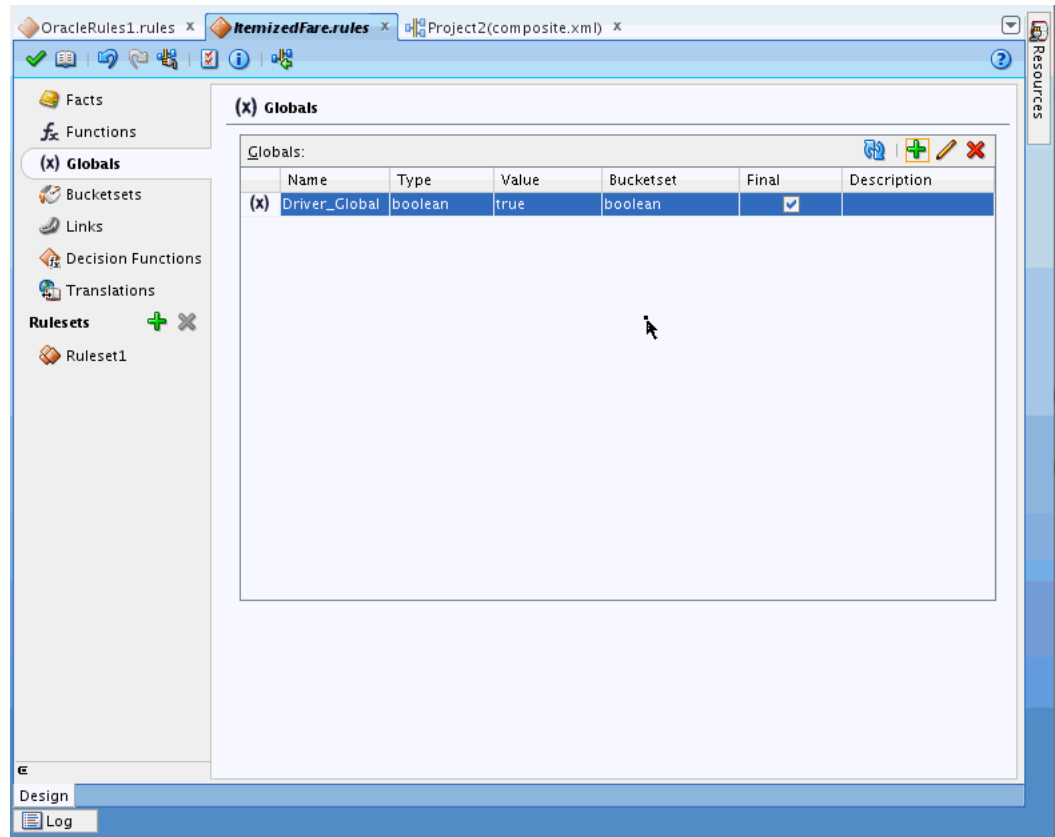
### 3.7.3 How to Associate a Bucketset with a Global Value

To prepare for creating Decision Tables, you can associate a global bucketset with global values in the data model.

**To associate a bucketset with a global value:**

1. From Rules Designer, select the **Globals** navigation tab.
2. Select the global value to edit.
3. In the Globals table, under **Bucketset**, select the cell for the appropriate global value, and from the list, select the bucketset that you want to associate with the global value. For example, see [Figure 3–27](#).

Figure 3-27 Defining a Bucketset for a Global Value





---

---

## Working with Rulesets and Rules

This chapter describes the Oracle Business Rules data model element called ruleset that you use to group one or more rules and Decision Tables. It also discusses how to work with dictionaries, nested tests, and advanced and tree mode rules, and Expression Builder.

The chapter includes the following sections:

- [Section 4.1, "Introduction to Working with Rulesets and Rules"](#)
- [Section 4.2, "Working with Rulesets"](#)
- [Section 4.3, "Working with Rules"](#)
- [Section 4.4, "Validating Dictionaries"](#)
- [Section 4.5, "Using Advanced Settings with Rules and Decision Tables"](#)
- [Section 4.6, "Working with Nested Tests"](#)
- [Section 4.7, "Working with Advanced Mode Rules"](#)
- [Section 4.8, "Working with Tree Mode Rules"](#)
- [Section 4.9, "Using Date Facts, Date Functions, and Specifying Effective Dates"](#)
- [Section 4.10, "Working with Expression Builder"](#)
- [Section 4.11, "Using Bucketsets as Constraints for Options Values in Rules"](#)

For more information, see [Section 1.1.5, "What Are Rulesets?"](#).

### 4.1 Introduction to Working with Rulesets and Rules

You can use business rules to define key decisions and policies for a business, including:

- **Business Policies:** for example spending policies and approval matrices
- **Constraints:** for example valid configurations or regulatory requirements
- **Computations:** for example discounts, premiums, or scores
- **Reasoning Capabilities:** for example offers based on customer value

Oracle Business Rules provides two ways to work with rules:

- Using IF/THEN rules
- Using rules in a Decision Table

This chapter describes working with IF/THEN rules. For information on Decision Tables, see [Chapter 5, "Working with Decision Tables"](#).

## 4.2 Working with Rulesets

A ruleset provides a unit of execution for rules and for Decision Tables. In addition, rulesets provide a unit of sharing for rules; rules belong to a ruleset. Multiple rulesets can be executed in order. This is called rule flow. The ruleset stack determines the order. The order can be manipulated by rule actions that push and pop rulesets on the stack. In rulesets, the priority of rules applies to specify the order of firing of the rules in the ruleset. Rulesets also provide an effective date specification that identifies that the ruleset is always active, or that the ruleset is restricted based on a time and date range, or a starting or ending time and date.

### 4.2.1 How to Create a Ruleset

All rules and Decision Tables are created in a ruleset. A ruleset organizes rules and Decision Tables into a unit of execution.

**To create a ruleset:**

1. In Rules Designer, go to the **Rulesets** navigation tab.
2. Click the **Create Ruleset...** icon. This displays the Create Ruleset dialog.
3. Enter a name in the **Name** field.
4. Enter a description in the **Description** field, as shown in [Figure 4-1](#).

**Figure 4-1 Adding a Ruleset**



5. Click **OK**.

### 4.2.2 How to Set the Effective Date for a Ruleset

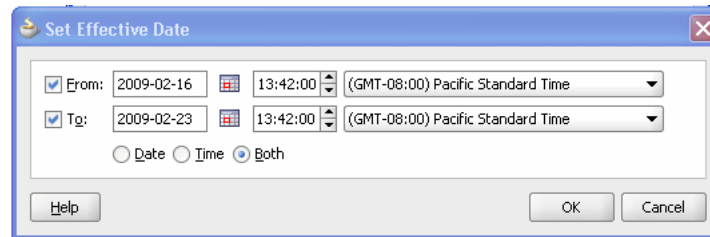
Effective date support provides the ability to specify a start date and an end date for a ruleset, a rule or a Decision Table. For a ruleset the effective date defines the date range in which the rules and Decision Tables within the ruleset are effective. For more information on effective dates, see [Section 4.9, "Using Date Facts, Date Functions, and Specifying Effective Dates"](#).

**To set the effective date for a ruleset:**

1. Select the ruleset name from the **Rulesets** navigation tab.
2. Click the navigation icon next to the ruleset name to expand the ruleset information to show the ruleset **Name**, **Description**, and **Effective Date** fields, as shown in [Figure 4-2](#).

**Figure 4–2 Ruleset Showing Effective Date Field**

3. Select the **Effective Date** entry. This displays the Set Effective Date dialog, as shown in [Figure 4–3](#).

**Figure 4–3 Using the Set Effective Date Dialog**

4. Use the Set Effective Date dialog to specify the effective dates for the ruleset. Clicking the **Set Date** icon displays a calendar to assist you in entering the **From** and **To** field data.

### 4.2.3 How to Use a Filter to Display Matching Rules in a Ruleset

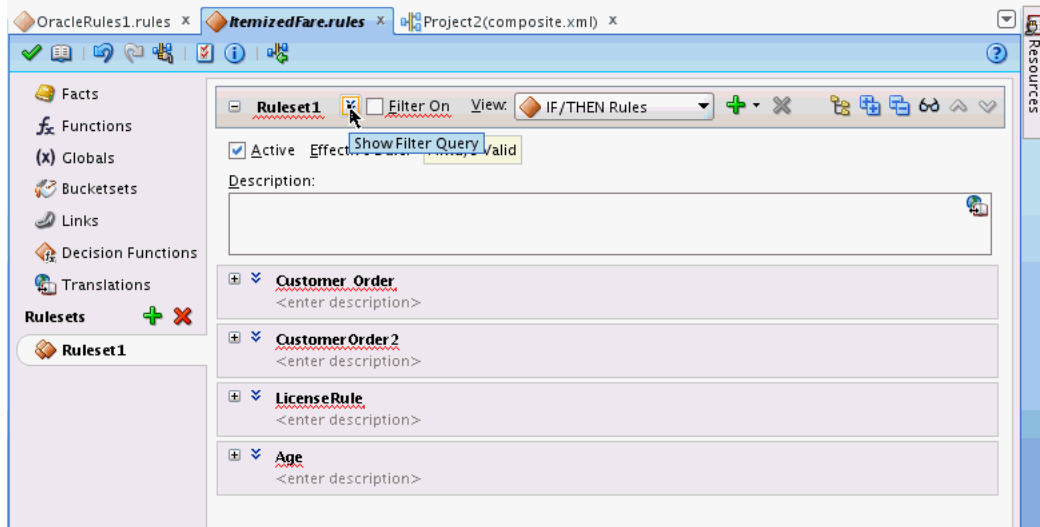
As the number of rules in a ruleset increases, it can be difficult to navigate the list of rules. You can instruct Rules Designer to filter the list of rules, to display only rules of interest. For example, you can display only active rules or only rules that have validation warnings.

For more information on creating rules, see [Section 4.3, "Working with Rules"](#).

#### To use a filter to display matching rules in a ruleset:

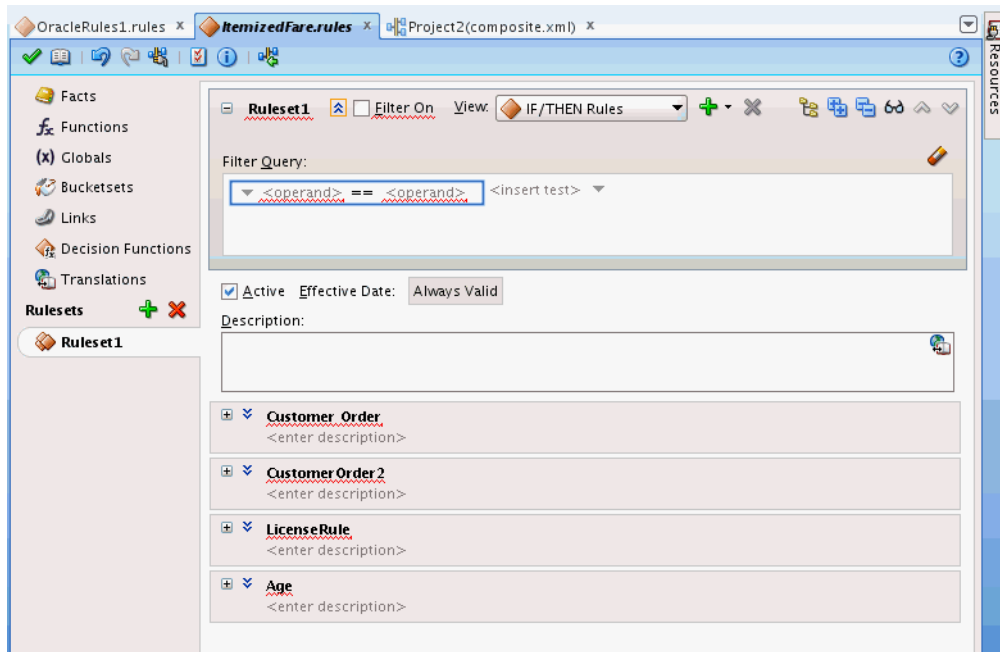
1. In Rules Designer, select a ruleset from the **Rulesets** navigation tab.
2. To show the rule filter settings, next to the ruleset name, click **Show Filter Query** as [Figure 4–4](#) shows.

**Figure 4–4** Showing a Filter Query in a Ruleset



3. In the **Filter Query** field, click **<insert test>** to insert a default test as [Figure 4–5](#) shows.

**Figure 4–5** Inserting a Default Filter Query Test



4. Configure the default test.  
In this case, as shown in [Figure 4–6](#), when you click an **<operand>** you can choose from the rule-specific options shown in [Table 4–1](#).

**Table 4–1** Rule Filter Query Operands

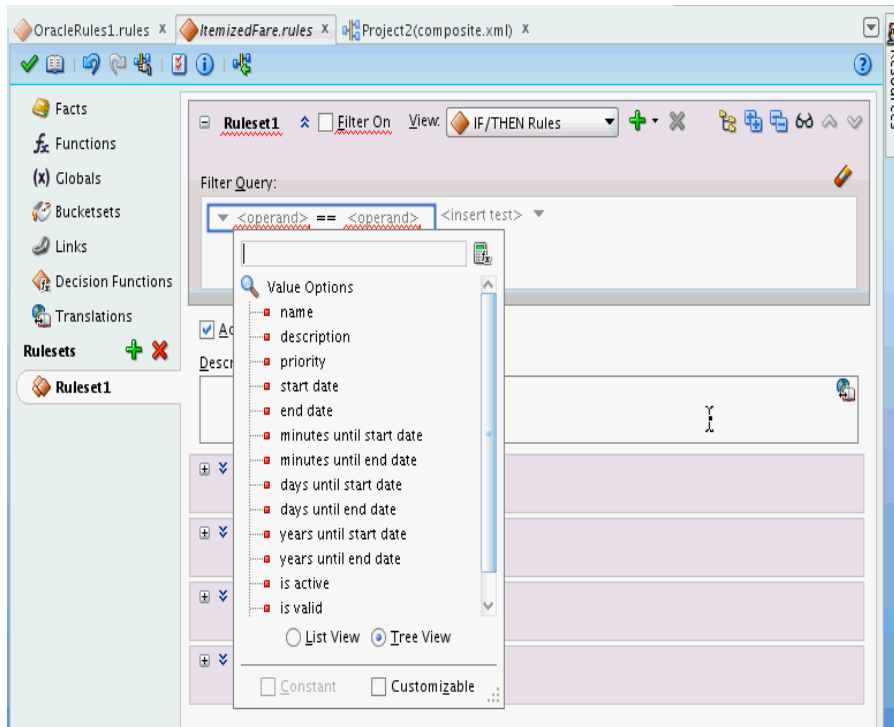
Operand	Description
name	Matches against the rule name.
description	Matches against the rule description.



**Table 4–1 (Cont.) Rule Filter Query Operands**

<b>Operand</b>	<b>Description</b>
priority	Matches against the rule priority. For more information, see <a href="#">Section 4.5.5, "How to Set a Priority for a Rule"</a> .
start date	Matches against the rule start date. For more information, see <a href="#">Section 4.9.2, "How to Set the Effective Date for a Rule"</a> .
end date	Matches against the rule end date. For more information, see <a href="#">Section 4.9.2, "How to Set the Effective Date for a Rule"</a> .
minutes until start date	Matches against a specified number of minutes until the rule start date. For more information, see <a href="#">Section 4.9.2, "How to Set the Effective Date for a Rule"</a> .
minutes until end date	Matches against a specified number of minutes until the rule end date. For more information, see <a href="#">Section 4.9.2, "How to Set the Effective Date for a Rule"</a> .
days until start date	Matches against a specified number of days until the rule start date. For more information, see <a href="#">Section 4.9.2, "How to Set the Effective Date for a Rule"</a> .
days until end date	Matches against a specified number of days until the rule end date. For more information, see <a href="#">Section 4.9.2, "How to Set the Effective Date for a Rule"</a> .
years until start date	Matches against a specified number of years until the rule start date. For more information, see <a href="#">Section 4.9.2, "How to Set the Effective Date for a Rule"</a> .
years until end date	Matches against a specified number of years until the rule end date. For more information, see <a href="#">Section 4.9.2, "How to Set the Effective Date for a Rule"</a> .
is active	Matches against whether the rule is active. For more information, see <a href="#">Section 4.5.3, "How to Select the Active Option"</a> .
is valid	Matches against whether the rule has validation warnings. For more information, see <a href="#">Section 4.4.2, "Understanding Rule Validation"</a> .
referenced fact types	Matches against one or more fact types.

Figure 4–6 Filter Query Operands

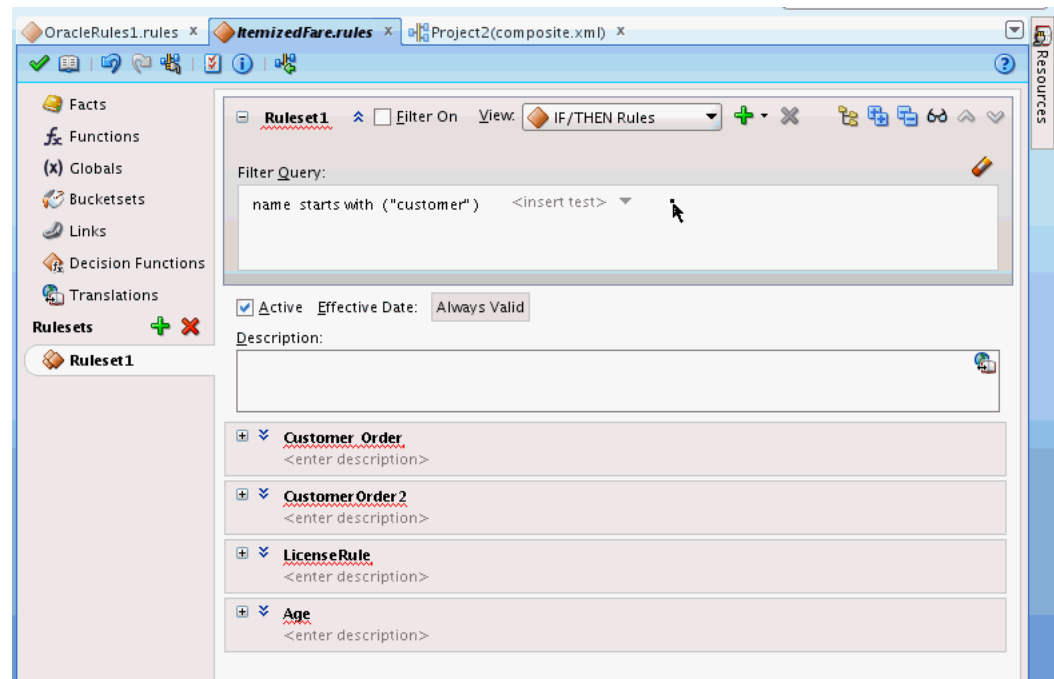


For more information, see [Section 4.3.2, "How to Define a Test in a Rule"](#).

5. Select the operator to choose an operator for the comparison. For example, for the name you can select **startsWith** from the operand list.
6. Enter a comparison operand for the right-hand-side of the filter test. For example, enter the string `Customer`.
7. When the filter query is complete you can apply the filter to the rules in the ruleset:
  - a. To apply the filter, select the **Filter On** checkbox.

Rules Designer displays only the rules that match the filter query as [Figure 4–7](#) shows.

**Figure 4–7 Enable Filter Query in a Ruleset with Filter On Option**



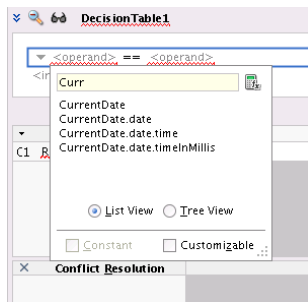
- b. To disable the filter query, deselect the **Filter On** checkbox.  
Rules Designer displays all the rules in the ruleset.
- c. To delete the filter query, select it and press **Delete** or click the **Clear Filter** icon.

#### 4.2.4 Using Auto Complete when Selecting Component Values from a List

The Rules Designer enables you to easily set values for the following components of a business rule:

- Expressions
- Conditions
- Operands
- Actions

You can edit these components by clicking them in the Rules Editor and selecting the desired value from a drop down list or tree. You can also enter the name of the desired value in the text area at the top of the list. When you begin entering text, the list of options are filtered as shown in [Figure 4–8](#).

**Figure 4–8 Using the Auto Complete Function**

In this figure, only the options beginning with the text entered are displayed.

## 4.3 Working with Rules

You create business rules to process facts and to obtain intermediate conclusions that Oracle Business Rules can process. You create rules in a ruleset, so before working with rules you need to create a ruleset (or use the default ruleset). For more information on creating a ruleset, see [Section 4.2, "Working with Rulesets"](#).

You can easily test your rules as you are designing them without having to deploy your application. For more information, see [Section 8.1.5, "How to Test a Decision Function Using an Oracle Business Rules Function"](#).

Rules Designer rule validation can assist you when you work with rules. To show the validation log window, click the **Validate** icon or select **View>Log** and select the **Business Rule Validation** tab. This displays warnings for incorrect or incomplete rules. Note that you must correct all warnings before you can test or deploy rules. For more information on rule validation, see [Section 4.4.2, "Understanding Rule Validation"](#).

As the number of rules in a ruleset increases, you can configure Rules Designer to filter the list of rules to show only rules of interest. For more information, see [Section 4.2.3, "How to Use a Filter to Display Matching Rules in a Ruleset"](#).

### 4.3.1 How to Add Rules

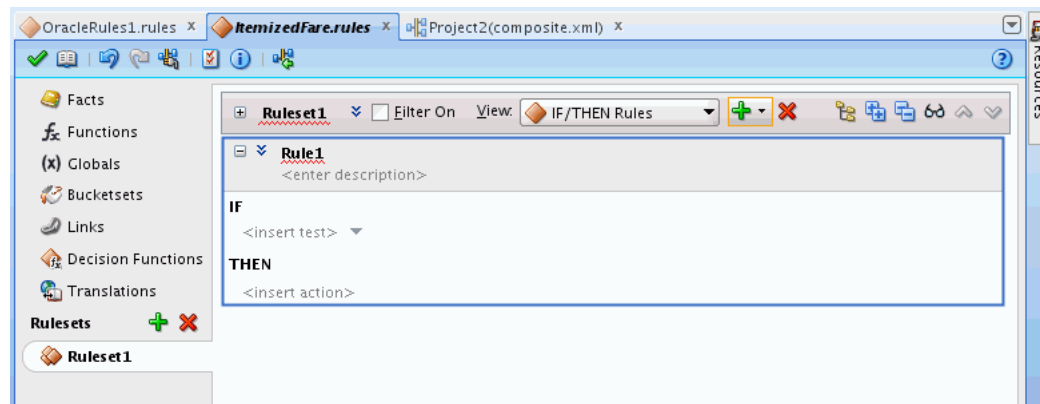
To create a rule you first add the rule to a ruleset, and then you insert tests and actions. The actions are associated with pattern matches. At runtime when a test in the **IF** area of a rule matches, the Rules Engine activates the **THEN** action and prepares to run the actions associated with the rule.

Rules Designer lets you create a rule where by default the rule fires for each matching fact. To enable other options, where the same fact type matches more than once, or never, you select **Advanced Mode**. For more information on advanced mode and showing advanced settings, see [Section 4.5, "Using Advanced Settings with Rules and Decision Tables"](#).

#### To add rules in a ruleset:

1. In Rules Designer, select a ruleset from the **Rulesets** navigation tab.
2. In the **View** field, select **IF/THEN Rules**.
3. Click **Add** to add a rule. For example, click **Add** to add a rule named `Rule_1`, as shown in [Figure 4–9](#).

Figure 4–9 Adding a Rule in a Ruleset

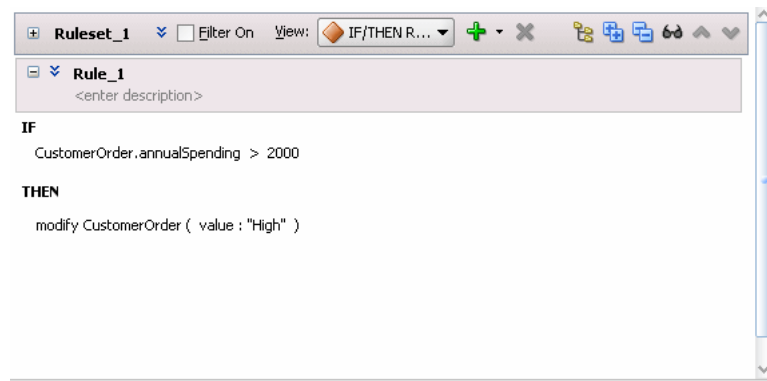


### 4.3.2 How to Define a Test in a Rule

To create a test in a rule you add conditions for facts. For example, with a sample `CustomerOrder` fact with an `annualSpending` property, you can add a test to determine if a customer order is associated with a high value of spending, based on the annual spending for the customer. Note that you can use bucketsets to limit the values for tests and actions in rules. For more information, see [Section 4.11, "Using Bucketsets as Constraints for Options Values in Rules"](#).

Figure 4–10 shows this sample rule.

Figure 4–10 Adding a Test to a Rule



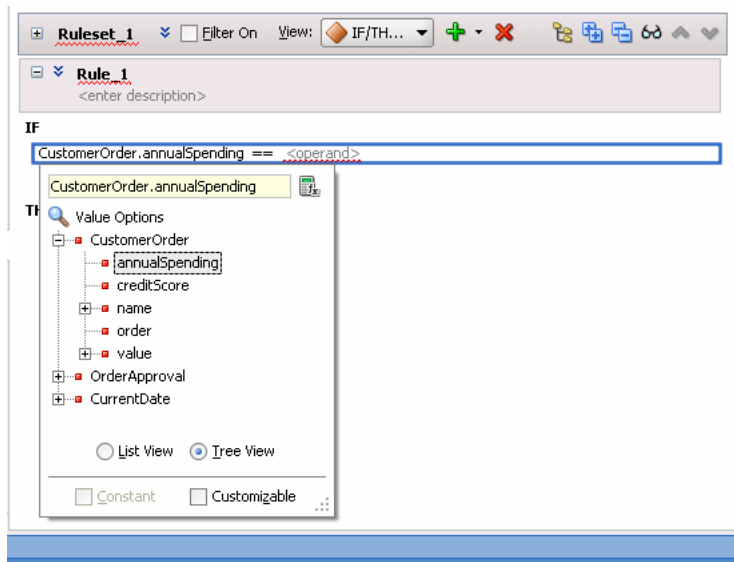
At runtime, when this rule is processed the Rules Engine checks the facts against rule pattern tests that you define to find matching facts. For this sample rule, `Rule_1`, when a fact matches the Rules Engine modifies the fact and then modifies the value property to "High".

#### To define tests in rules:

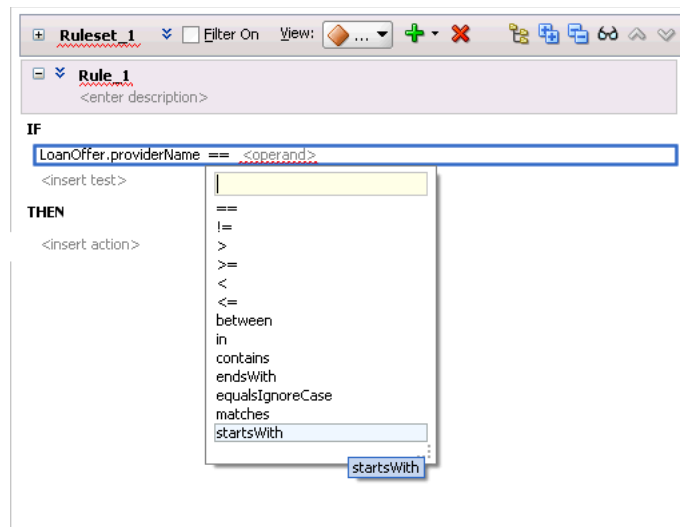
1. In Rules Designer, select a ruleset from the **Rulesets** navigation tab.
2. In the **View** field, select **IF/THEN Rules** (this is the Rules Designer default).
3. Add or select the rule you want to use, for example, select **Rule\_1**.
4. In **Rule\_1**, in the **IF** area, select **<insert test>**.
5. For a test, the **IF** area of a rule includes a left-hand-side `<operand>` and a right-hand-side `<operand>`, as shown in [Figure 4–11](#).

**Figure 4–11 Rule Test with Left-hand-side operand and Right-hand-side operand**

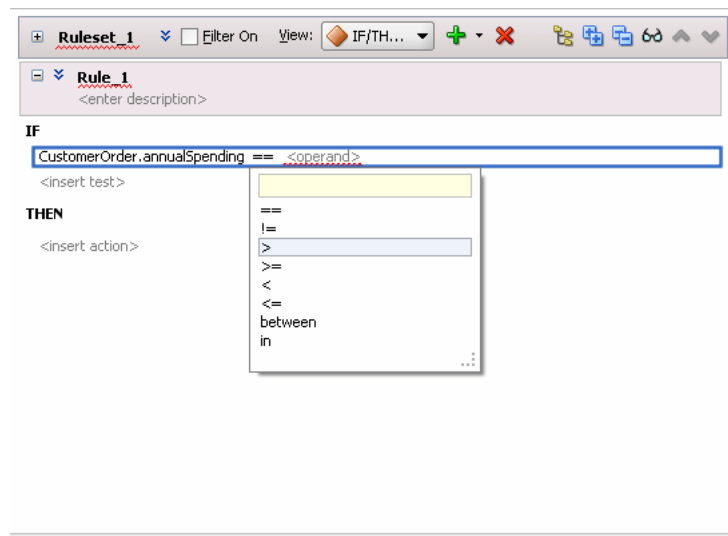
6. In a test, you replace the left-hand-side operand with a value.  
To do this, select the left-hand-side **<operand>**. This displays a text entry area and a list, as shown in [Figure 4–12](#):

**Figure 4–12 Configuring the Left-hand-side Operand of a Test in a Rule**

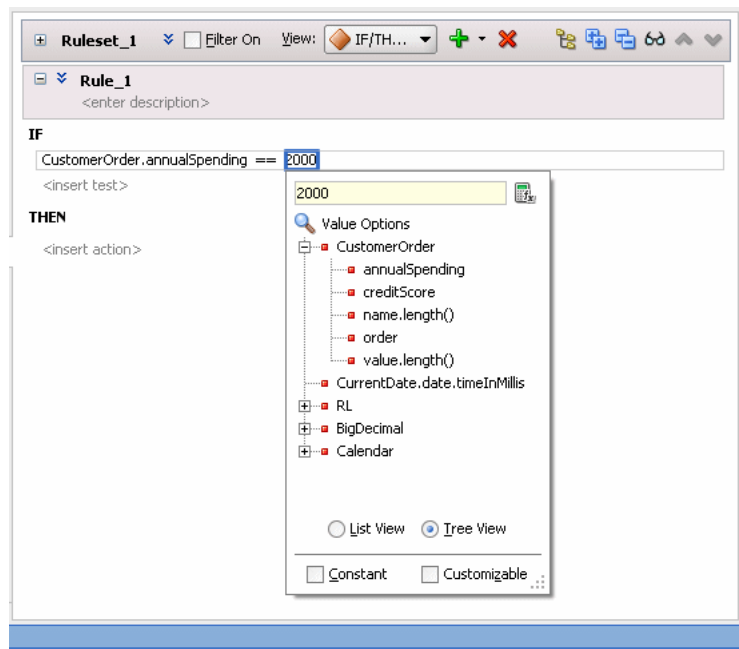
- a. To enter a value use the list to select an item from the value options.  
You can view the options using a single list, by selecting **List View**, or using a navigator by selecting **Tree View**.
  - b. To enter a literal value, type the value into the text entry area and press **Enter**.  
The value you enter must agree with the type of the corresponding operand. For example, in the test **IF** `CustomerOrder.annualSpending > <operand>`, valid values for **<operand>** must agree with the type of `CustomerOrder` field `annualSpending`.
7. In a test, you replace the operator with the desired logical operator or accept the default (`==`). To do this, select the default `==` operator. This displays a field and a list. The list may contain additional operators, depending on the datatype of the left operand. For example, to test strings, if you select a `String` operand on the left hand side, then additional `String` operators, such as `startsWith` and `equalsIgnoreCase` are available as shown in [Figure 4–13](#).

**Figure 4–13** Configuring String Operators in a Rule

Similarly, to test a logical condition between the left-hand and right-hand operands, select one of the logical operators as shown in [Figure 4–14](#): == (equality), != (not equal), > (greater than), >= (greater than or equal to), < (less than), <= (less than or equal to). For more information on the operators, see [Appendix B, "Oracle Business Rules Built-in Classes and Functions."](#)

**Figure 4–14** Configuring the Operator of a Test in a Rule

8. In a test, you replace the right-hand-side operand with a value. Configure the **<operand>** placeholder as you would for any operand. For example, enter 2000 into the text entry area and press **Enter** or **Return**, as shown in [Figure 4–15](#).

**Figure 4–15** Configuring the Right-hand-side Operand of a Test in a Rule

### 4.3.3 What You Need to Know About Oracle Business Rules Test Variables

Oracle Business Rules test variables provide a way to shorten lengthy expressions that occur in rule and decision table conditions and actions. The variable and its value can be represented as an inline business term definition. The test variables are also called as inline aliases.

The option to insert test variables appears as a list next to **<insert test>** in the rules condition section. As part of the definition of rule condition, you can define a variable to represent a complex expression, a mathematical expression, or callouts to functions.

For example you have an XML fact called `Song` that has an attribute as `composer` having a function called `size`. When referring to the attribute, instead of using `Song.composer.size()` every time, you can just define a variable as the following:

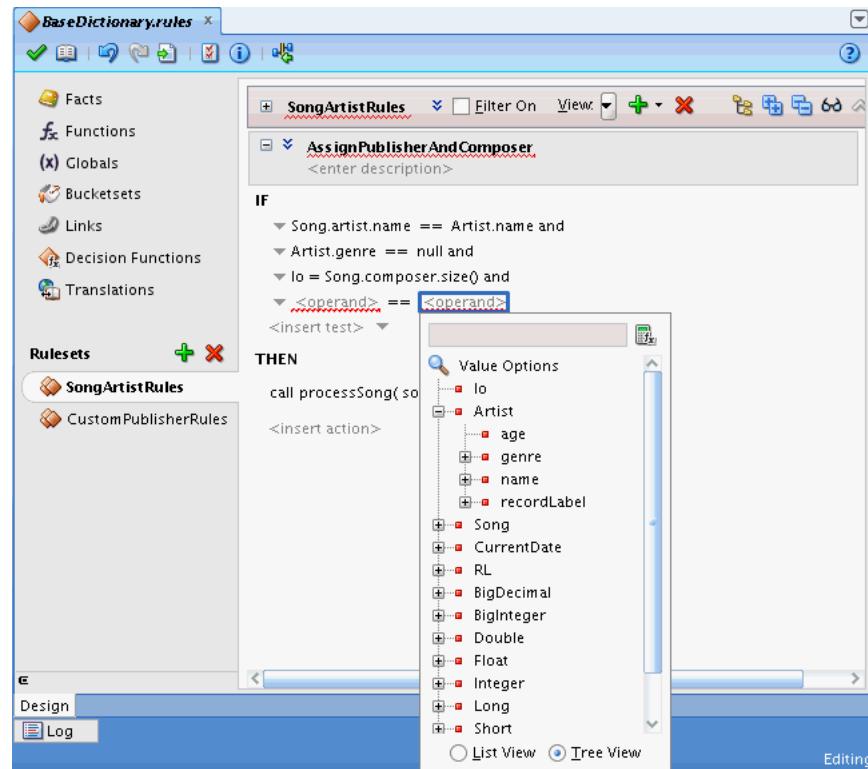
```
lo = Song.composer.size()
```

Subsequently, in tests, you can use `lo` as part of your expressions. The expression can be anything from a simple to a complex expression. For example, in the body of a function, if you click **<insert action>**, you can see expression as a part of the available options.

Figure 4–16 displays a test variable.



Figure 4–16 Rules Test Variable



Once you define an inline alias, for subsequent test conditions, the inline alias is available in the list of the operands. The scope of an inline alias is restricted to the subsequent tests in a particular rule, in which the inline alias is defined. In case of a nested test, you can still use the inline alias, because the nested test is a part of the base test where you have defined the alias. This is true even for any test that you define even within the nested test. The scope of the inline alias is not just restricted to the test conditions of the base and its nested test, but also to the actions of that rule. If the inline alias is defined as a part of a nested test condition and not as a part of the main test condition, even then the alias will be available to all the subsequent test conditions and actions within or outside the main nested test.

However, if you define an inline alias inside a not nested test, then the scope of the inline alias is restricted only to the subsequent tests inside the not nested test and not to any tests that are outside the not nested test.

The inline aliases can be used both in If-Then rules as well as Decision Tables. In a Decision Table, in advanced mode, you can show or hide patterns as well as enter a pattern by clicking **<insert pattern>**. After you insert a pattern, you can insert tests. In normal mode, you can show or hide tests as well as enter a test by clicking **<insert test>**.

#### 4.3.4 How to Define Range Tests in Rules

To create a range test in a rule, you add conditions for facts. For example, with a sample `CustomerOrder` fact with an `annualSpending` property, you can add a test to determine if the value of a customer order falls between an upper and lower range.

The following summarizes this sample rule:

```

IF
  CustomerOrder.annualSpending between 100 and 2000

```

```
THEN
    Modify CustomerOrder.value = "Normal"
```

At runtime, when this rule is processed the Rules Engine checks the facts against rule pattern tests that you define to find matching facts.

#### To define range tests in rules:

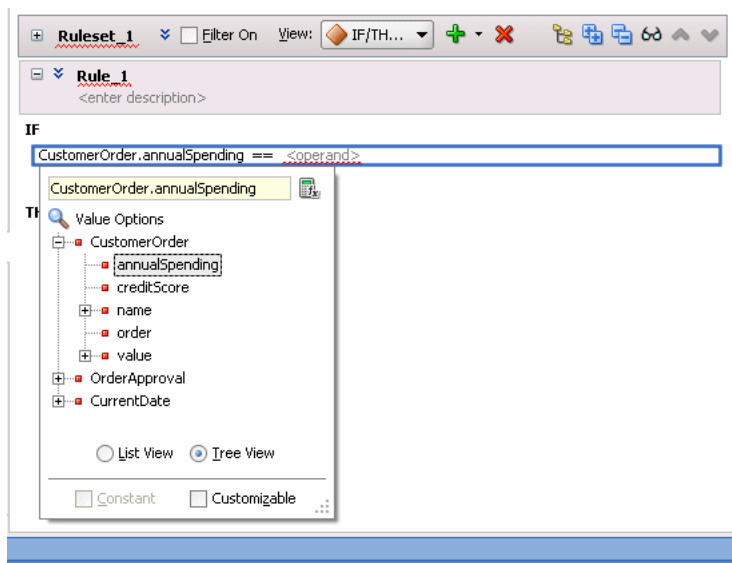
1. In Rules Designer, select a ruleset from the **Rulesets** navigation tab.
2. In the **View** field, select **IF/THEN Rules** (this is the Rules Designer default).
3. Add or select the rule you want to use, for example, select **Rule\_1**.
4. In **Rule\_1**, in the **IF** area, select **<insert test>**.
5. The test in the **IF** area of a rule includes a left-hand side **<operand>** and a right-hand-side **<operand>**, as shown in [Figure 4-17](#).

**Figure 4-17 Rule Test with Left-hand-side operand and Right-hand-side operand**



6. In a range test, you replace the left-hand-side operand with a value. To do this, select the left-hand-side **<operand>**. This displays a text entry area and a list, as shown in [Figure 4-18](#):

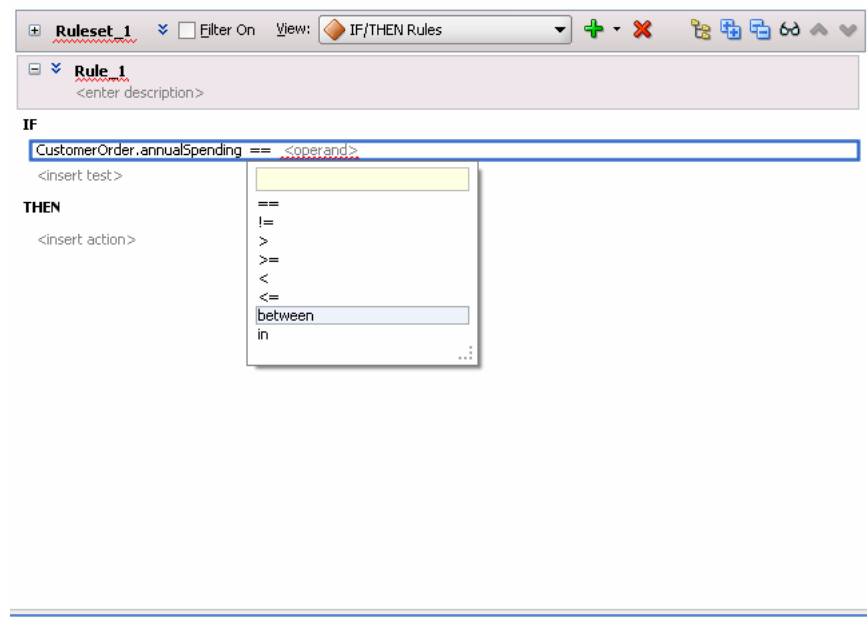
**Figure 4-18 Adding a Test Left-hand-side Operand to a Rule**



- a. To enter a value, use the list to select an item from the value options. You can view the options using a single list, by selecting **List View**, or using a navigator by selecting **Tree View**.

- b. To enter a literal value, type the value into the text entry area and press **Enter**. The value you enter must agree with the type of the corresponding operand.
- For example, in the test **IF** `CustomerOrder.annualSpending > <operand>`, valid values for **<operand>** must agree with the type of `CustomerOrder.annualSpending`.
7. In a range test, you choose the between operator. To do this, select the default `==` operator. This displays a text entry area and a list. Select **between** as shown in [Figure 4–19](#).

**Figure 4–19** Configuring the Operator of a Range Test in a Rule



This adds two more **<operand>** placeholders as shown in [Figure 4–20](#).

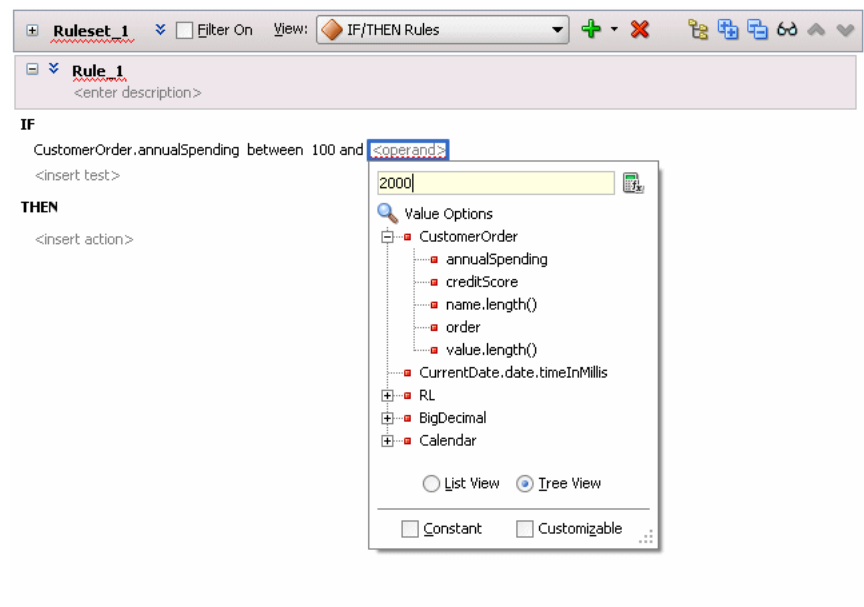
**Figure 4–20** Between Operator in a Range Test

```

IF
CustomerOrder.annualSpending between <operand> and <operand>
<insert test>
THEN
<insert action>

```

8. Configure the **<operand>** placeholders as you would for any operand as shown in [Figure 4–21](#).

**Figure 4–21** Configuring the Operand of a Range Test in a Rule

The test is true when the left-most operand (`CustomerOrder.annualSpending`) is between the values 100 and 2000.

### 4.3.5 How to Define Set Tests in Rules

To create a set test in a rule, you add conditions for facts. For example, with a sample `CustomerOrder` fact with a line item property you can add a test to determine if the line item belongs to an arbitrary set of products.

The following summarizes this sample rule:

```

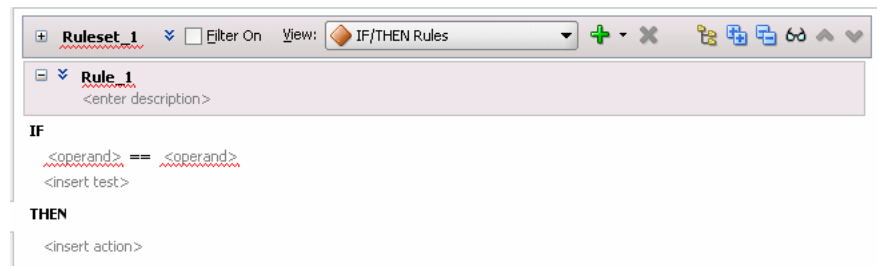
IF
    CustomerOrder.lineItem.sku in 12345, 43255, 76348
THEN
    Modify CustomerOrder.value = "High"

```

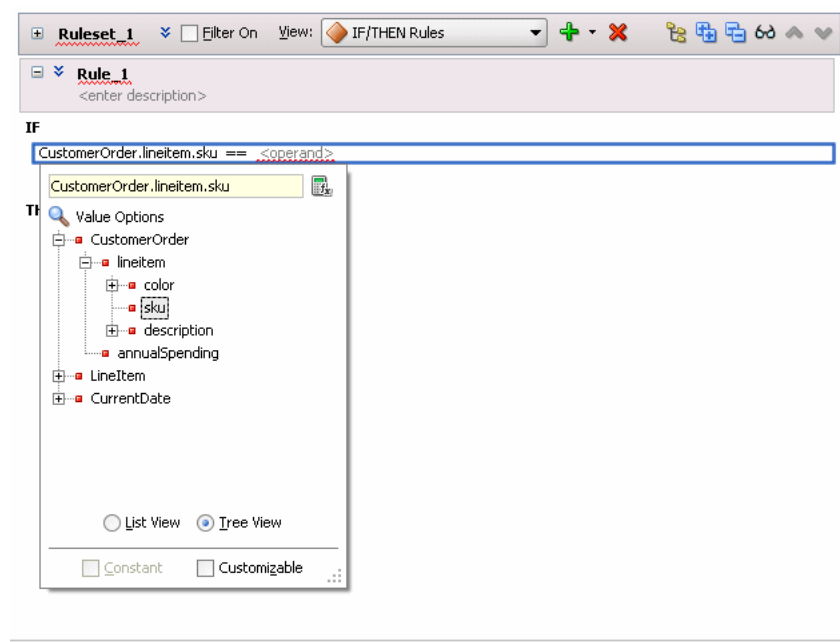
At runtime, when this rule is processed the Rules Engine checks the facts against rule pattern tests that you define to find matching facts.

#### To define set tests in rules:

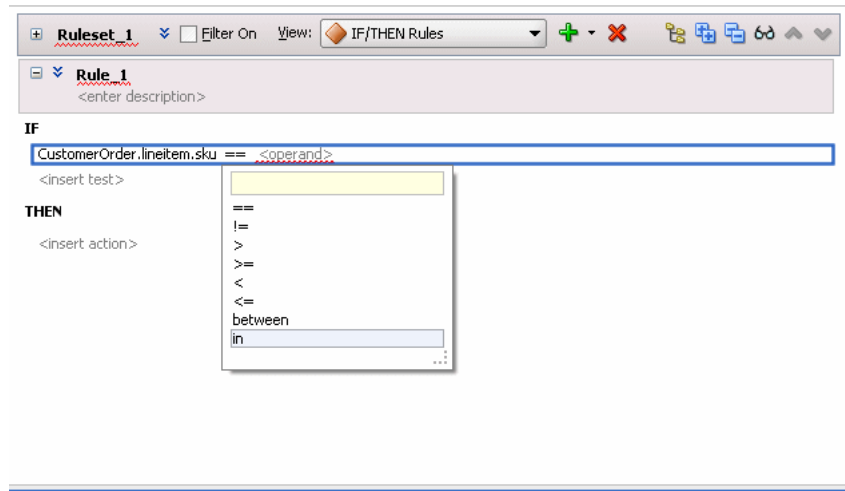
1. In Rules Designer, select a ruleset from the **Rulesets** navigation tab.
2. In the **View** field, select **IF/THEN Rules** (this is the Rules Designer default).
3. Add or select the rule you want to use, for example select **Rule\_1**.
4. In **Rule\_1**, in the **IF** area select **<insert test>**.
5. The test in the **IF** area of a rule includes a left-hand side **<operand>** and a right-hand-side **<operand>**, as shown in [Figure 4–11](#).

**Figure 4–22 Rule Test with Left-hand-side operand and Right-hand-side operand**

6. In a set test, you replace the left-hand-side operand with a value. To do this, select the left-hand-side **<operand>**. This displays a text entry area and a list as shown in [Figure 4–23](#):

**Figure 4–23 Adding a Test Left-hand-side Operand to a Rule**

- a. To enter a value use the list to select an item from the value options. You can view the options using a single list, by selecting **List View**, or using a navigator by selecting **Tree View**.
  - b. To enter a literal value, type the value into the text entry area and press **Enter**.
7. In a set test, you use the **in** operator. To do this, select the default **==** operator. This displays a text entry area and a list. Select **in** as shown in [Figure 4–24](#).

**Figure 4–24** Configuring the Operator of a Set Test in a Rule

This adds two more <operand> placeholders in a comma separated list and an <insert> placeholder as shown in [Figure 4–25](#).

**Figure 4–25** In Operator in a Set Test

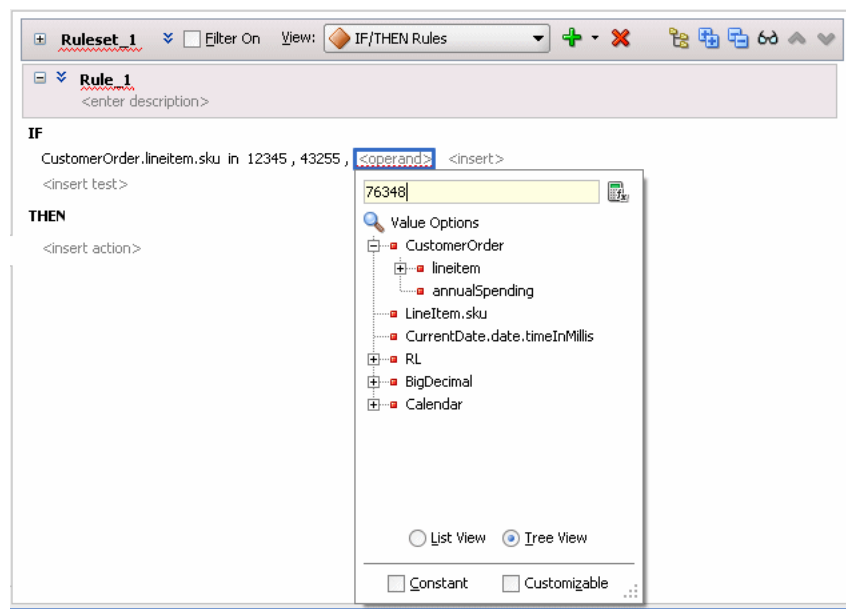
```

IF
  CustomerOrder.lineItem.sku in <operand>, <operand> <insert>
  <insert test>
THEN
  <insert action>
  
```

To add another operand to the list, click <insert>.

To delete an operand from the list, right-click the operand and select **Delete Test Expression**.

8. Configure the <operand> placeholders as you would for any operand as shown in [Figure 4–26](#).

**Figure 4–26** Configuring the Operands of a Set Test in a Rule

The test is true when the value of the left-most operand (`CustomerOrder.lineItem.sku`) is any of 12345, 43255, or 76348.

### 4.3.6 How to Define Actions in Rules

To create a rule you insert tests and you insert actions. The actions are associated with pattern matches. When a test in the **IF** area of a rule matches, the Rules Engine activates the **THEN** action and prepares to run the actions associated with the rule.

When you add an action, you use one of the forms of actions shown in [Table 4–2](#). For each form shown in [Table 4–2](#) the options that Rules Designer presents are context sensitive, so the lists and the number of items you work with may be different, depending on which action you add and the choices you make while you enter the action. [Table 4–2](#) shows the basic actions; additional actions are available with Advanced Mode. For more information on advanced mode see [Section 4.5, "Using Advanced Settings with Rules and Decision Tables"](#).

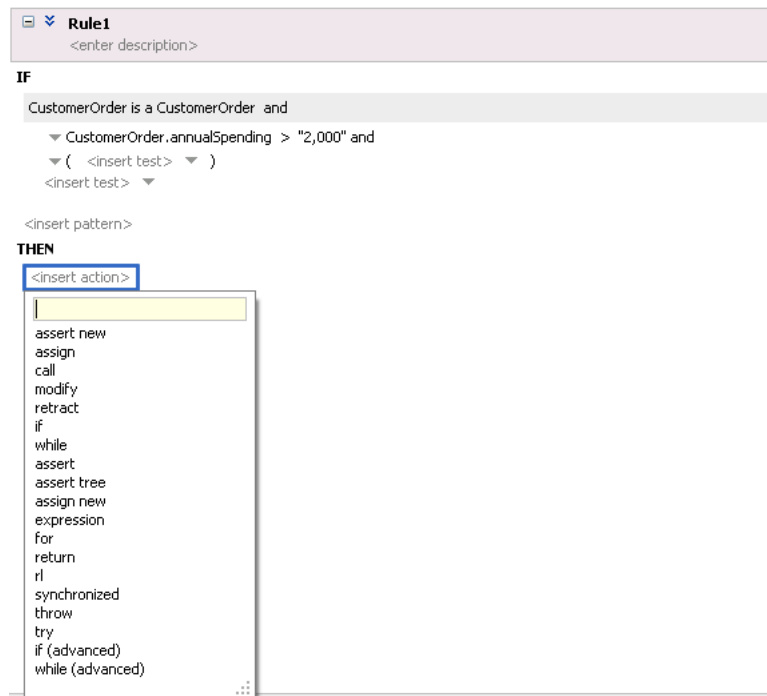
**Table 4–2** Rule Action Choices

Action Form	Description
Assert New	Assert a new fact
Modify	Modify a data value associated with a matched fact
Retract	Retract a fact
Call	Call a function
If, else, elseif, for, while	Conditional actions

#### To define actions in rules:

1. In Rules Designer, select a ruleset from the **Rulesets** navigation tab.
2. In a rule, in the **THEN** area, select **<insert action>**. This displays the add action list as shown in [Figure 4–27](#).

**Figure 4–27 Adding a Modify Action to a Rule**

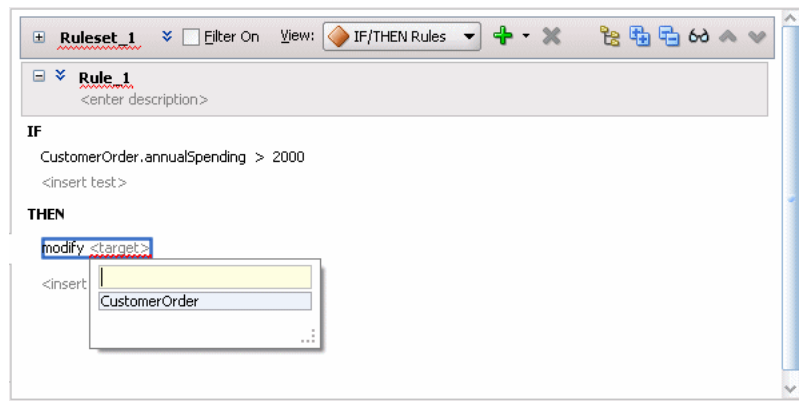


3. In the add action list, select the type of action you want to add. For example, select **modify**. You can also enter the name of the action in the text area. As you begin entering a name, the list of available choices is automatically filters. This is useful when there are a large number of options available.

You can add any required action ranging from assert, call, modify to even conditional actions such as if, else, elseif, while, for, if (advanced), and while (advanced) as shown in

4. In the **THEN** area, select **<target>** to display the option list. For example, select customerOrder as shown in [Figure 4–28](#).

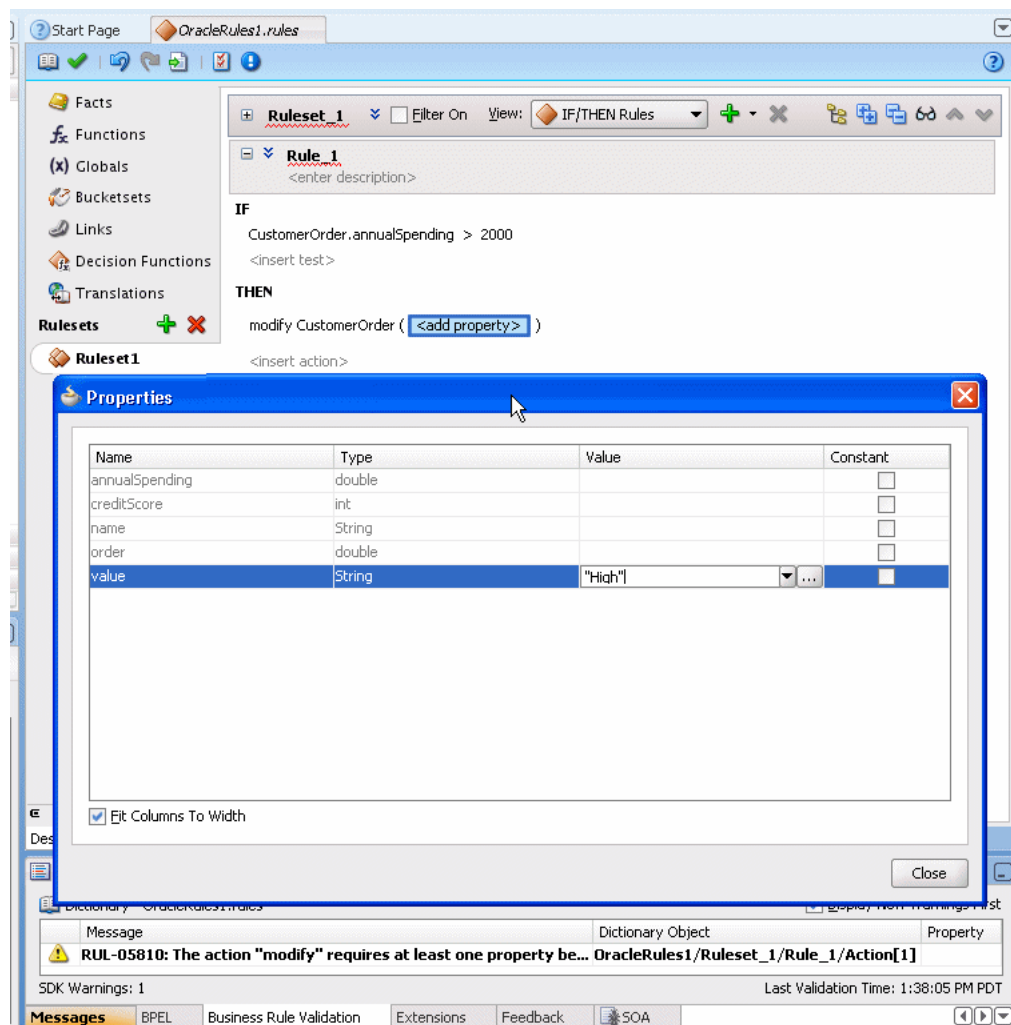
**Figure 4–28 Adding Modify Action to a Rule and Selecting the Target**



5. Select **<add property>**. This displays the Properties dialog.
6. In the Properties dialog, in the **Value** column, enter "High" (include the double quotation marks) and press **Enter** or **Return** as shown in [Figure 4–29](#).

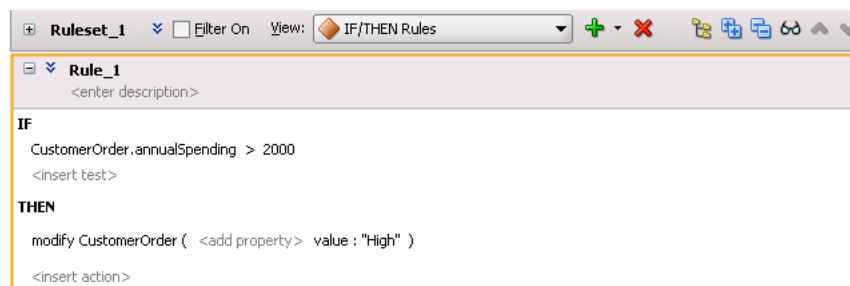


Figure 4–29 Adding Modify Action Property and Value to a Rule



- In the Properties dialog, click **Close**. This displays the rule as shown in Figure 4–30.

Figure 4–30 Rule with Test and Action Added



### 4.3.7 What You Need to Know About Rule Actions

A rule loop occurs when the value for a condition is changed by an action. Loops can occur across rules in a single rule, spread over several Decision Tables, or spread over rules and Decision Tables in the same ruleset. You need to avoid creating rule actions

that modify fact properties that are used in rule conditions. At runtime, such rules could cause an infinite loop.

### 4.3.8 What You Need to Know About Oracle Business Rules Performance Tuning

In most cases, writing of rules should not require a focus on performance. However, there are tips that can help you to enhance and maximize rule performance.

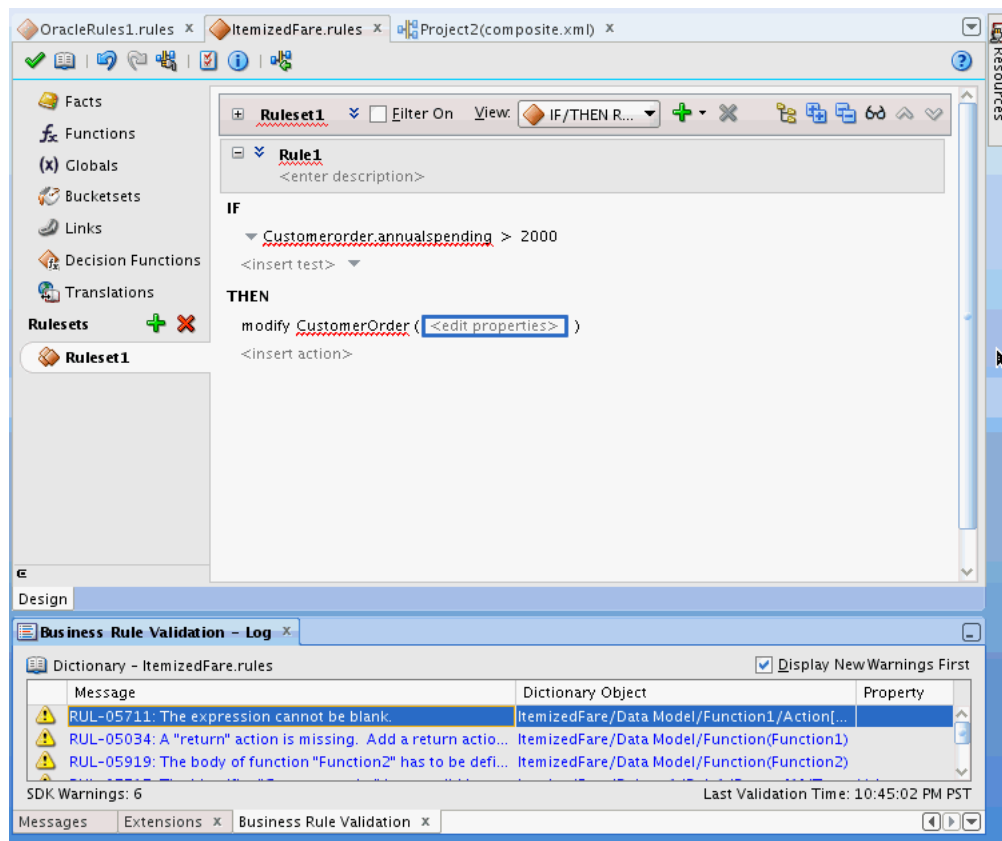
For more information on Oracle Business Rules performance tuning, see "Oracle Business Rules Performance Tuning" in *Tuning Performance*.

## 4.4 Validating Dictionaries

Rules Designer performs dictionary validation when you make any change to the dictionary. Rules Designer validation can assist you when you work with rules or Decision Tables. To show the validation log window, click the **Validate** icon or select **View>Log** and select the **Business Rule Validation** tab. This displays warnings for incorrect or incomplete rules. Note that you must correct all warnings before you can test or deploy rules.

When a dictionary is invalid, Rules Designer produces a list of warning messages and lists the associated dictionary objects. You can use the validation message information to locate the dictionary object and to correct problems. In addition, Rules Designer flags objects with validation warnings with a validation indicator (a red, wavy underline), as shown in [Figure 4-31](#).

**Figure 4-31 Validation Warnings Shown in Log and On Screen with Wavy Underline**



If a dictionary is invalid, you can save the dictionary. However, you can only generate RL Language for a dictionary that is valid and does not display warnings in the Rules Designer validation log.

In the validation log, each validation message includes the following:

- **Message:** The message provides details on the Oracle Business Rules exception that describes the problem.
- **Dictionary Object:** This field displays a path that indicates details that should allow you to identify a component in the dictionary.
- **Property:** provides information on a property of the object associated with the warning message.

When you are viewing the validation log, if you select an item and then right-click and select from the list **Select and Highlight Object in Editor**, Rules Designer moves the cursor to select the dictionary object. Note that for some validation warnings this functionality is not possible.

#### 4.4.1 Understanding Data Model Validation

Rules Designer performs dictionary validation when you make any change to the dictionary. When Rules Designer displays a warning message, the validation log includes a message that should assist you in locating the dictionary object that caused the validation warning. For example, the following string indicates that the warning originates from the data model object named `RLFact_1`. In addition, the problem is in the property named `test_int`:

```
CarRental/Data Model/RLFact_1/test_int/Expression
```

[Table 4–3](#) specifies the parts of the dictionary object name specified in a validation message.

**Table 4–3 Data Model Dictionary Property in Validation Log**

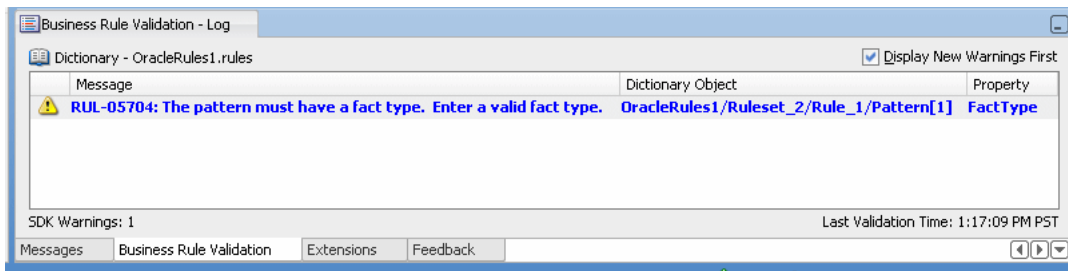
Name	Description
CarRental	Dictionary Name
Data Model	Data Model component in dictionary.
RLFact_1	Element name in data model
test_int	Property name in the specified element.
Expression	Expression part of property.

For more information, see:

- [Section 4.4.2, "Understanding Rule Validation"](#)
- [Section 4.4.3, "Understanding Decision Table Validation"](#)
- [Section 4.4.4, "How to Validate a Dictionary"](#)

#### 4.4.2 Understanding Rule Validation

When you click the **Validate** icon Rules Designer displays the validation log. When you first add a rule you see validation warnings similar to those shown in [Figure 4–32](#).

**Figure 4–32 Rules Validation Messages**

The dictionary object name part of a validation message for a rule includes details that help you to identify the ruleset, the rule, and an area in the rule that is associated with the validation warning. For example, the following dictionary object specification indicates a problem:

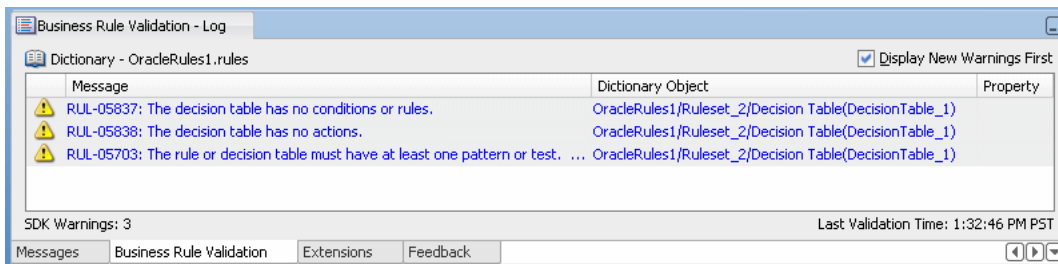
```
OracleRules1/Ruleset_2/Rule_1/Pattern[1]
```

In validation messages, the dictionary object name for a rule uses indexes that start at 1. Thus, the first pattern is `Pattern[1]`.

In addition to validating rules, you can also test them in Rules Designer as you are designing them. For more information, see [Section 8.1.5, "How to Test a Decision Function Using an Oracle Business Rules Function"](#).

### 4.4.3 Understanding Decision Table Validation

When you click the **Validate** icon Rules Designer displays the validation log. When you first add a Decision Table you see validation warnings similar to those shown in [Figure 4–33](#).

**Figure 4–33 Decision Table Validation Messages**

The dictionary object name part of a validation message for a Decision Table includes details that help you to identify the area of the Decision Table that is associated with the validation warning. For example, the following dictionary object specification indicates a problem in the first action row, and the first action cell of the Decision Table:

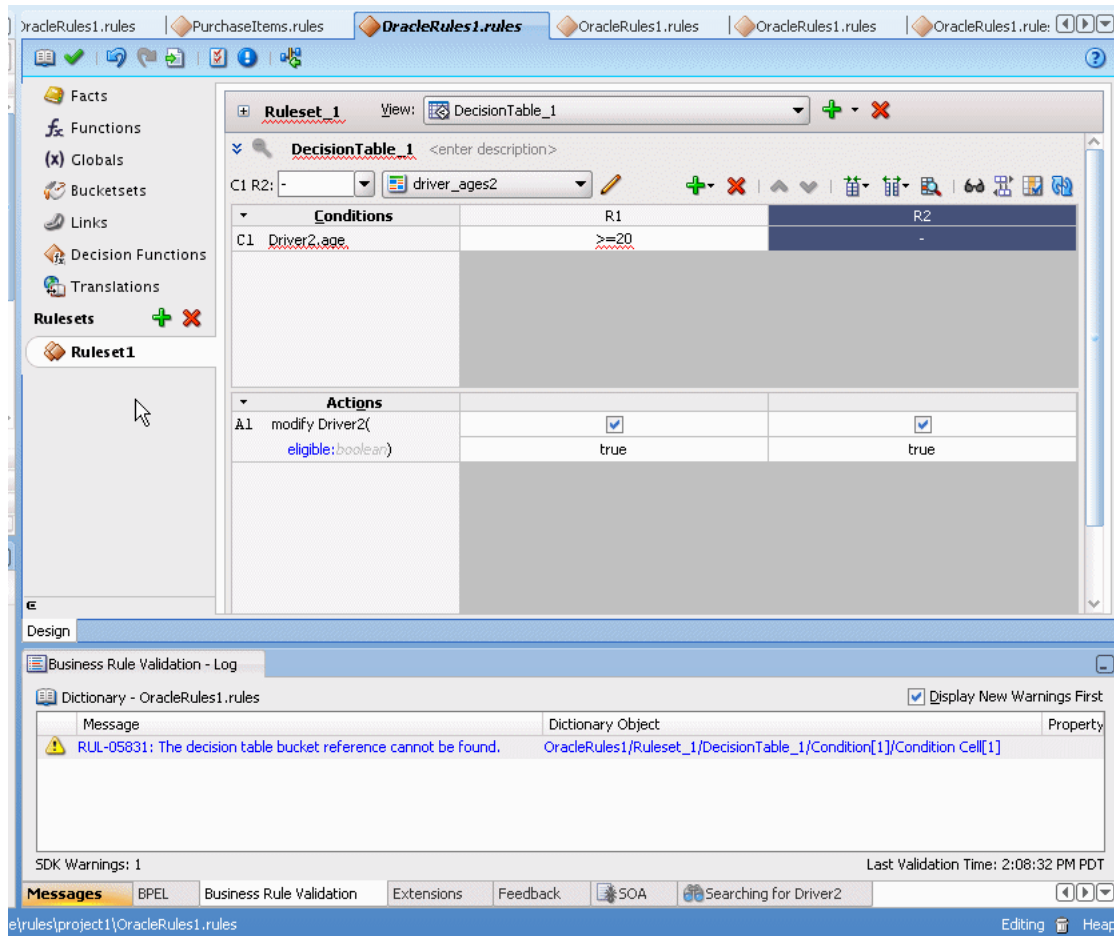
```
OR1/Ruleset_1/DecisionTable_1/Action[1]/Action Cell[1]
```

In validation messages the dictionary object name for a Decision Table object uses indexes that start at 1. For example, to indicate the first condition cell in the first row in the **Conditions** area, the message is as follows:

```
OracleRules1/Ruleset_1/DecisionTable_2/Condition[1]/Condition Cell[1]
```

This specification indicates the condition cell for the rule with the label R1 in the first row of the **Conditions** area in a Decision Table as shown in [Figure 4–34](#).

Figure 4–34 Decision Table with Warning on a Condition Cell



#### 4.4.4 How to Validate a Dictionary

Rules Designer performs dictionary validation when you make any change to the dictionary.

##### To validate a dictionary:

1. In Rules Designer, click the **Validate** icon (a checkmark).
2. Select the Business Rule Validation log from the messages area.
3. When you are viewing the validation log, if you select an item and then right-click and select from the list **Select and Highlight Object in Editor**, Rules Designer moves the cursor to select the dictionary object. Note that for some validation warnings this functionality is not possible.

### 4.5 Using Advanced Settings with Rules and Decision Tables

Advanced settings for rules and Decision Tables let you work with features that provide advanced options that not all Oracle Business Rules users need. These features include:

- **Advanced Mode:** allows additional pattern matching options and nested tests in rules.

For more information, see:

- [Section 4.5.1, "How to Show and Hide Advanced Settings in a Rule or Decision Table"](#)
- [Section 4.5.2, "How to Select the Advanced Mode Option"](#)
- [Section 4.7.5, "What You Need to Know About Advanced Mode Rules"](#)
- **Tree Mode:** makes it easier to work with master detail hierarchy, nested elements that map to a parent child relationship. These parent child relationships among facts are common with XML and ADF Business Components fact types. You can use this option with the **Advanced Mode** option.  
For more information, see [Section 4.8.2, "How to Create Simple Tree Mode Rules"](#).
- **Rule Active:** specifies that a rule or Decision Table is active or inactive. When **Rule Active** is unselected, Rules Designer does not validate the specified rule or Decision Table.  
For more information, see [Section 4.5.3, "How to Select the Active Option"](#).
- **Logical:** allows you to enable or disable logical dependence between the facts that trigger a rule and the facts asserted by a rule.  
For more information, see [Section 4.5.4, "How to Select the Logical Option"](#).
- **Allow Gaps** (available only with Decision Table advanced settings). This checkbox determines if validation messages are reported when gaps are detected in a Decision Table. The specific validation message is:  

```
RUL-05852: Decision Table has gaps
```

  
For more information, see [Section 5.3.1.3, "Understanding Decision Table Gap Checking"](#) and [Section 5.3.5, "How to Perform Decision Table Gap Checking"](#).
- **Priority:** specifies the priority for a rule or a Decision Table. Higher priority rules run before lower priority rules, within a ruleset.  
For more information, see [Section 4.5.5, "How to Set a Priority for a Rule"](#).
- **Conflict Policy:** (available only with Decision Table advanced settings). Specifies the Decision Table conflict policy, one of the following:
  - **manual:** Conflicts are resolved by manually specifying a conflict resolution for each conflicting rule.
  - **auto override:** Conflicts are resolved automatically using an override conflict resolution when this is possible, using the automatic conflict resolution policies.
  - **ignore:** Conflicts are ignored.For more information, see [Section 5.3.1.4, "Understanding Decision Table Conflict Analysis"](#).
- **Effective Date:** specifies effective dates for a rule or a Decision Table.  
For more information, see, [Section 4.5.6, "How to Specify Effective Dates"](#).

## 4.5.1 How to Show and Hide Advanced Settings in a Rule or Decision Table

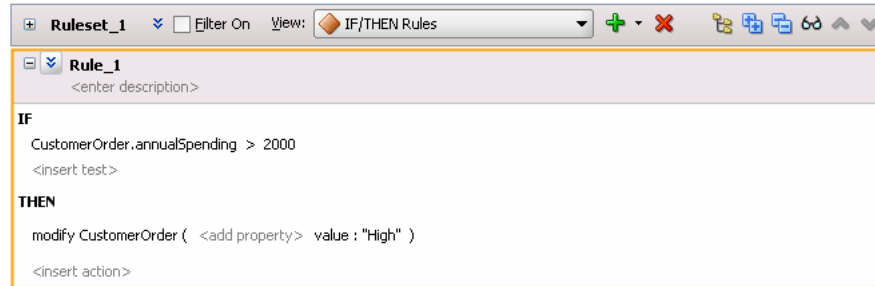
In Rules Designer, next to each rule name and Decision Table name, the show or hide advanced settings icon lets you show and hide advanced settings.

### To show and hide advanced settings in a rule or decision table:

1. Select the ruleset where you want to show advanced settings.

2. In the **View** field, from the list, select either **IF/THEN Rules** or select a Decision Table.
  - a. To show the advanced settings, next to the rule name click **Show Advanced Settings**, as shown in [Figure 4–35](#) (there is a highlighted icon shown next to the rule name, **Rule\_1**).

**Figure 4–35 Showing Rules Advanced Settings**



- b. To hide the advanced settings, next to the rule name click **Hide Advanced Settings**, as shown in [Figure 4–36](#) (there is a highlighted icon shown next to the rule name, **Rule\_1**).

**Figure 4–36 Hiding Advanced Settings in a Rule**

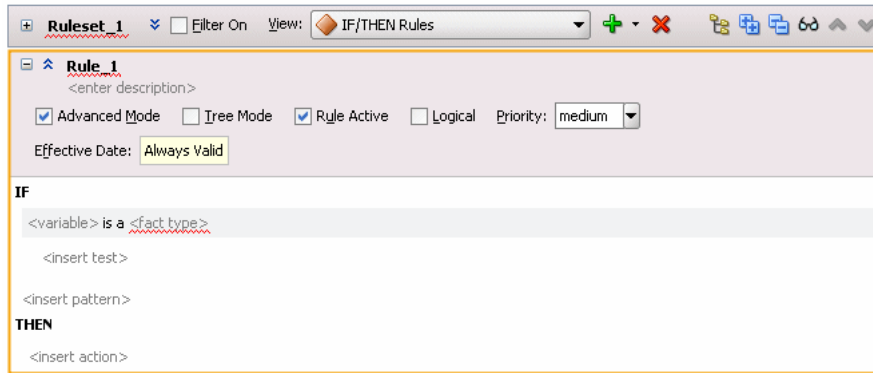


## 4.5.2 How to Select the Advanced Mode Option

Select Advanced Mode to use Rule or Decision Table features that provide additional pattern matching options and additional actions. For more information, see [Section 4.7, "Working with Advanced Mode Rules"](#).

### To select the advanced mode option:

1. Select the rule or Decision Table where you want to set Advanced Mode.
2. Click the **Show Advanced Settings** icon next to the rule or Decision Table name (see [Section 4.5.1, "How to Show and Hide Advanced Settings in a Rule or Decision Table"](#)).
3. Select **Advanced Mode**, as shown in [Figure 4–37](#).

**Figure 4–37 Setting Advanced Mode Option**

### 4.5.3 How to Select the Active Option

Oracle Business Rules includes the ability to specify that a rule or a Decision Table is active or inactive. The active option is set independent of the effective dates and may be set without changing or removing previously specified effective dates. When **Rule Active** is unselected, Rules Designer does not validate the rule.

#### To select the active option:

1. Select the rule or Decision Table where you want to set the **Rule Active** option.
2. Click the **Show Advanced Settings** icon next to the rule or Decision Table name (see [Section 4.5.1, "How to Show and Hide Advanced Settings in a Rule or Decision Table"](#)).
3. Select **Rule Active**.

### 4.5.4 How to Select the Logical Option

A ruleset or Decision Table with the **Logical** option selected specifies that rules in the generated RL Language use the logical property. The logical property allows you to enable or disable logical dependence between the facts that trigger a rule and the facts asserted by a rule.

A rule with the logical property enabled makes all facts that are asserted by an action block in the rule dependent on facts matched in the rule condition. Anytime a fact referenced in the rule condition changes, such that the rule's conditions no longer apply, the facts asserted by the rule condition are automatically retracted. For more information on the logical property, see *Rules Language Reference for Oracle Business Process Management*.

Using the ruleset and Decision Table **Logical** option you can enable or disable the logical property for the generated RL Language associated with the rules in the ruleset or the Decision Table. By default, the **Logical** option is not selected.

#### To select the logical option:

1. Select the rule or Decision Table where you want to set the **Logical** option.
2. Click the **Show Advanced Settings** icon next to the rule or Decision Table name (see [Section 4.5.1, "How to Show and Hide Advanced Settings in a Rule or Decision Table"](#)).
3. Select **Logical**.



## 4.5.5 How to Set a Priority for a Rule

You can set the priority for a rule or a Decision Table. You can select from a predefined named priority list as shown in [Table 4-4](#), or enter a positive or negative integer to specify your own priority level. Higher priority rules run before lower priority rules, within a ruleset. The default priority is `medium` (with the integer value 0).

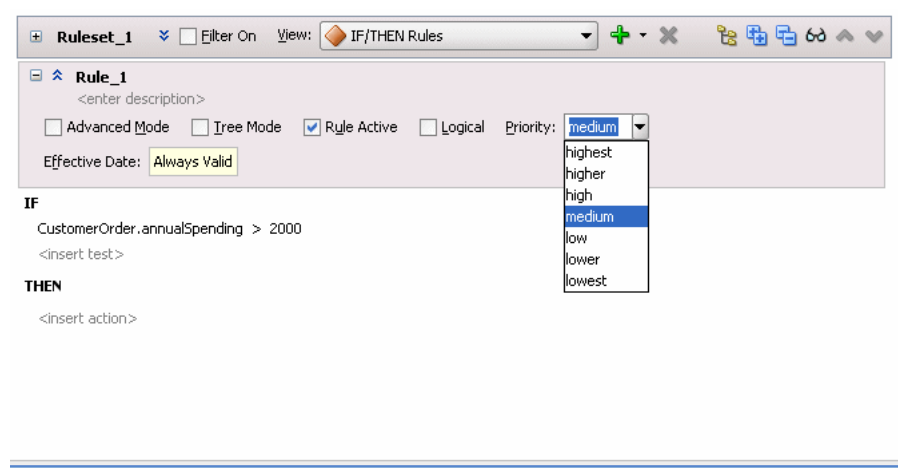
**Table 4-4** Priority String Value Mapping

Named Priority	Integer Value
highest	3000
higher	2000
high	1000
medium (Default Priority)	0
low	-1000
lower	-2000
lowest	-3000

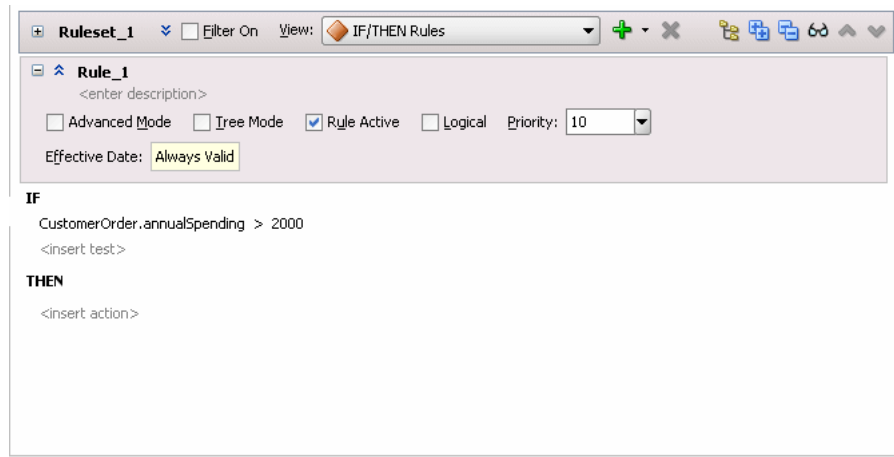
### To set a priority for a rule:

1. Select the rule or Decision Table where you want to set the priority.
2. Click the **Show Advanced Settings** icon next to the rule or Decision Table name (see [Section 4.5.1, "How to Show and Hide Advanced Settings in a Rule or Decision Table"](#)).
3. In the **Priority** field, specify the priority value:
  - a. To specify a named priority, select a named priority from the **Priority** list as [Figure 4-38](#) shows.

**Figure 4-38** Choosing a Predefined Named Priority



- b. To specify an integer priority, click in the Priority field and enter a positive or negative integer value and press **Enter**, as [Figure 4-39](#) shows.

**Figure 4–39** Choosing a User Defined Numeric Priority

## 4.5.6 How to Specify Effective Dates

You can specify effective dates for a ruleset, a rule, or a Decision Table.

### To specify effective dates:

1. Select the rule or Decision Table where you want to set the effective date.
2. Click the **Show Advanced Settings** icon next to the rule or Decision Table name (see [Section 4.5.1, "How to Show and Hide Advanced Settings in a Rule or Decision Table"](#)).
3. Select the **Effective Date** field. This displays the Set Effective Date dialog.
4. Use the Set Effective Date dialog to set the effective date.

For more information on using effective dates, see [Section 4.9, "Using Date Facts, Date Functions, and Specifying Effective Dates"](#) and [Section 4.2.2, "How to Set the Effective Date for a Ruleset"](#).

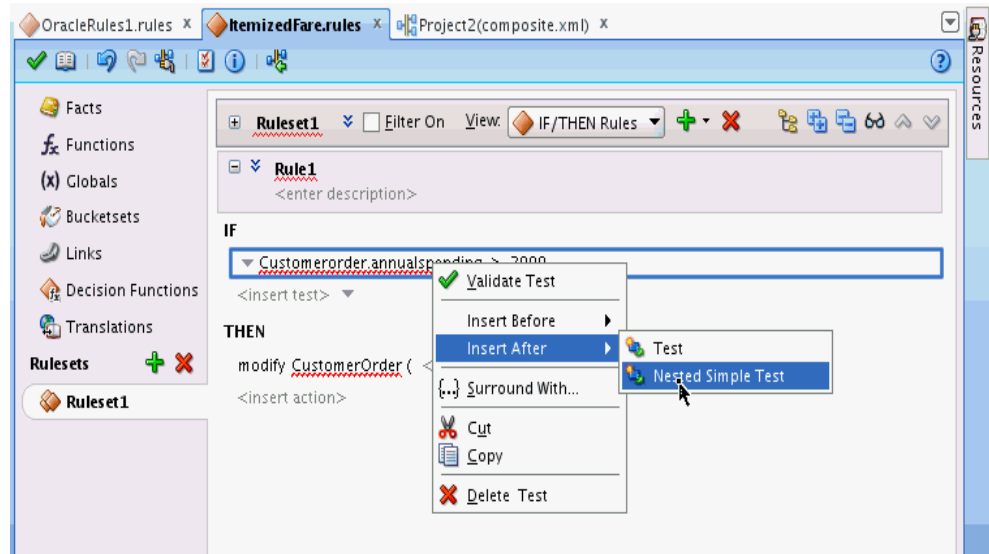
## 4.6 Working with Nested Tests

In a rule or a Decision Table you can create more complicated tests using the nested tests feature.

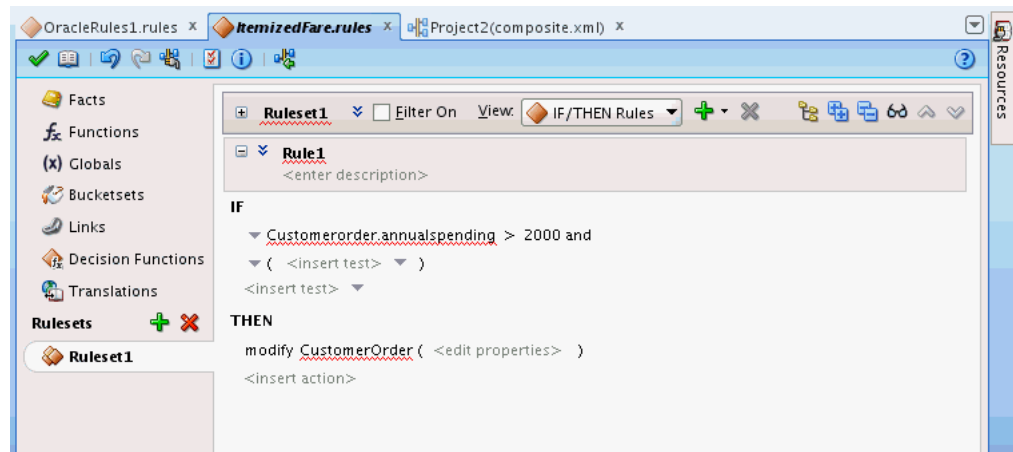
### 4.6.1 How to Use Nested Tests

#### To use nested tests:

1. Select the rule where you want to use a nested test.
2. In the **IF** area, select a test. This surrounds the test with a highlighted box.
3. With a test selected right-click to display the list, as shown in [Figure 4–40](#).

**Figure 4–40 Adding a Nested Test to a Rule**

4. To add the nested test, from the list select either **Insert Before** or **Insert After** and then select **Nested Test**. A nested test is shown in [Figure 4–41](#).

**Figure 4–41 A Nested Test Added to a Rule**

## 4.7 Working with Advanced Mode Rules

Oracle Business Rules provides features that allow you to create advanced rules that add support for the following Oracle Business Rules features:

- Additional Pattern Match options (see [Section 4.7.1, "How to Use Advanced Mode Pattern Matching Options"](#))
- Additional Matched Fact Naming options (see [Section 4.7.2, "How to Use Advanced Mode Matched Fact Naming"](#))
- Additional Supported Action forms (see [Section 4.7.3, "How to Use Advanced Mode Action Forms"](#))
- Pattern Match Aggregate Function options (see [Section 4.7.4, "How to Use Advanced Mode Aggregate Conditions"](#))

For more information, see [Section 4.7.5, "What You Need to Know About Advanced Mode Rules"](#).

## 4.7.1 How to Use Advanced Mode Pattern Matching Options

The advanced mode pattern matching options specify when a rule should fire. [Table 4–5](#) shows the available options.

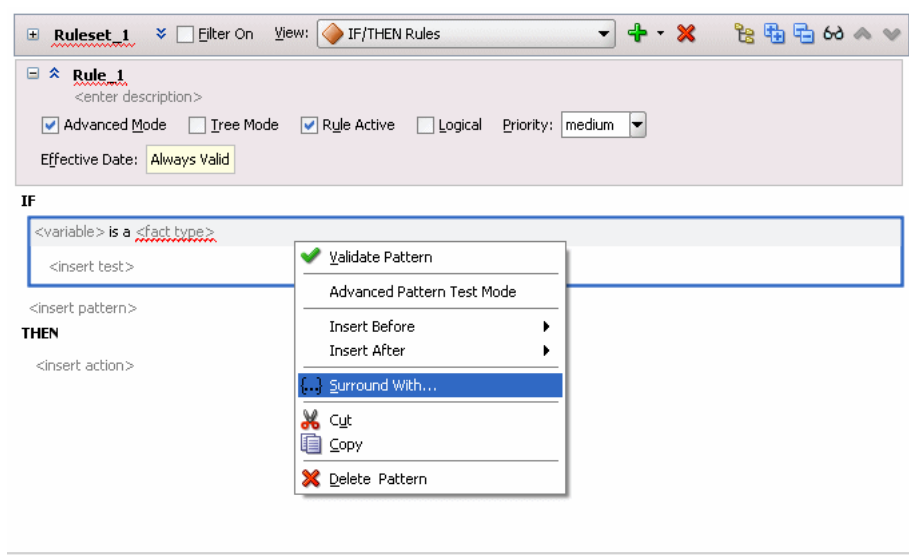
**Table 4–5 Advanced Mode Pattern Matching Options**

Option	Description
for each case where	This is the default pattern matching option. A rule should fire each time there is a match (for all matching cases).
there is a case where	This option selects one firing of the rule if there is at least one match.
there is no case where	The value specifies that the rule fires once if there are no such matches.
aggregate	This specifies an aggregate function is applied to all matches. For more information, see <a href="#">Section 4.7.4, "How to Use Advanced Mode Aggregate Conditions"</a> .

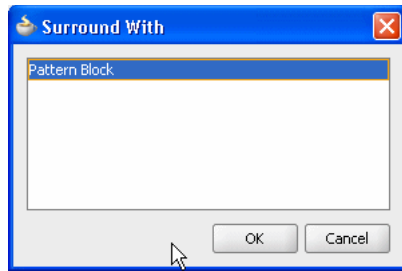
### To use advanced mode pattern matching options:

1. Select the rule or Decision Table where you want to use pattern matching options.
2. Click the **Show Advanced Settings** icon next to the rule or Decision Table name (see [Section 4.5.1, "How to Show and Hide Advanced Settings in a Rule or Decision Table"](#)).
3. Select **Advanced Mode**.
4. Right-click a test pattern and select **Surround With...** as shown in [Figure 4–42](#).

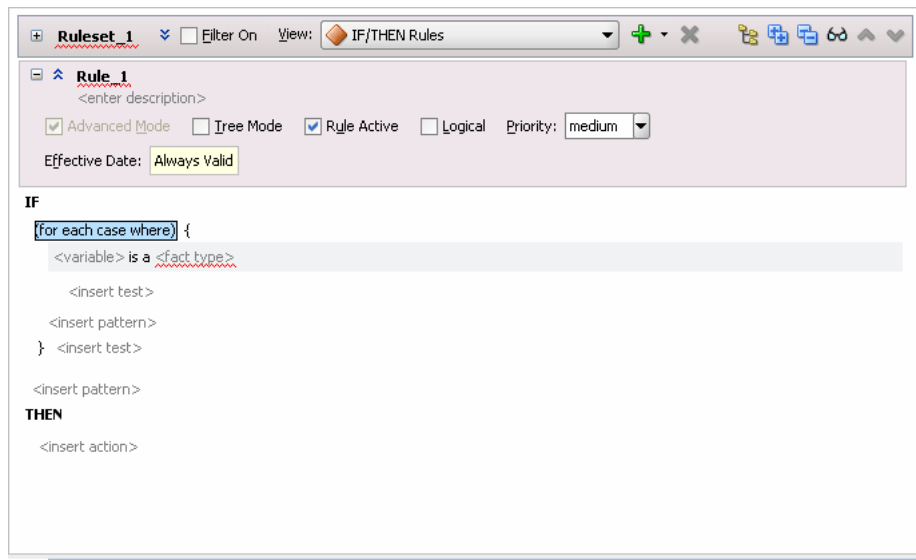
**Figure 4–42 Surrounding With Option**



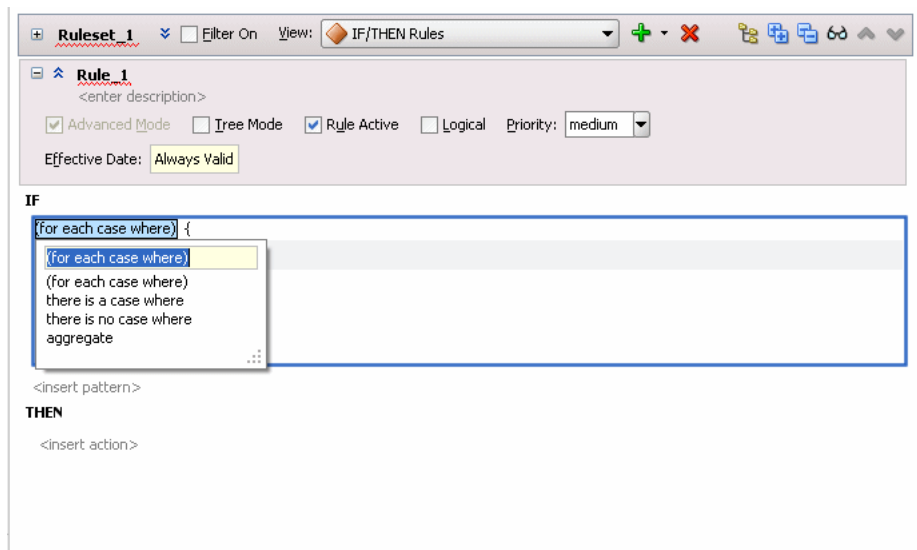
The Surround With dialog appears as shown in [Figure 4–43](#).

**Figure 4–43 Surround With Dialog**

5. Choose the **Pattern Block** option from the Surround With dialog and click **OK**.  
The pattern is surrounded by a nested pattern with the default (**for each case where**) as shown in [Figure 4–44](#).

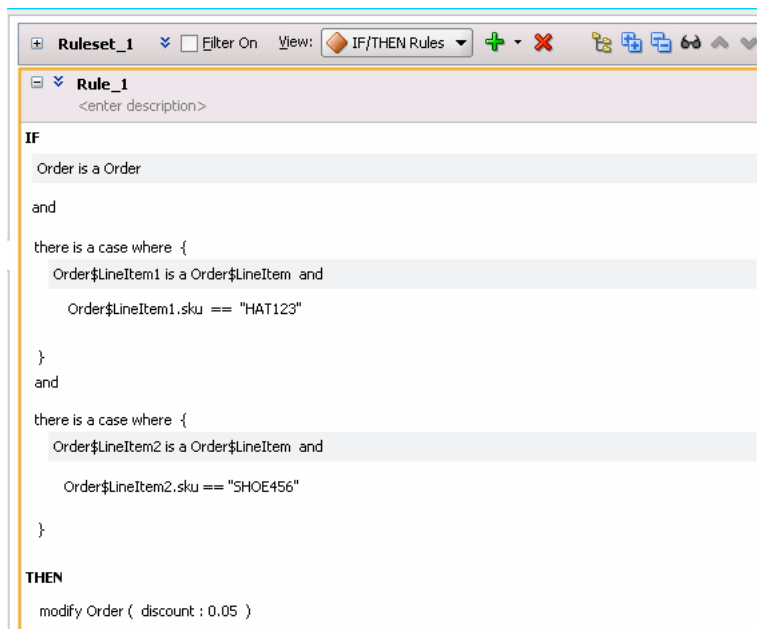
**Figure 4–44 Default Pattern Matching Option: for each case where**

6. Select the default (**for each case where**) option and select the desired pattern matching option from the list as shown in [Figure 4–45](#).

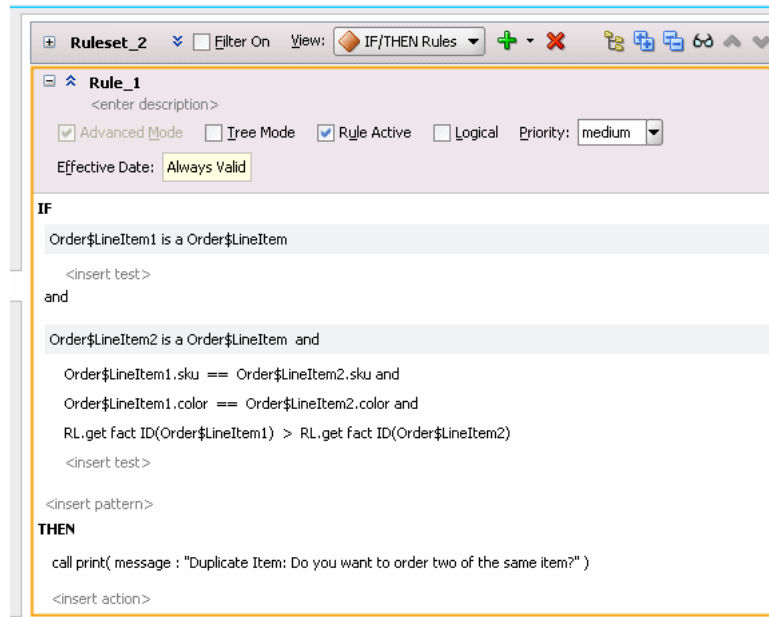
**Figure 4–45 Adding an Advanced Pattern Match Option**

## 4.7.2 How to Use Advanced Mode Matched Fact Naming

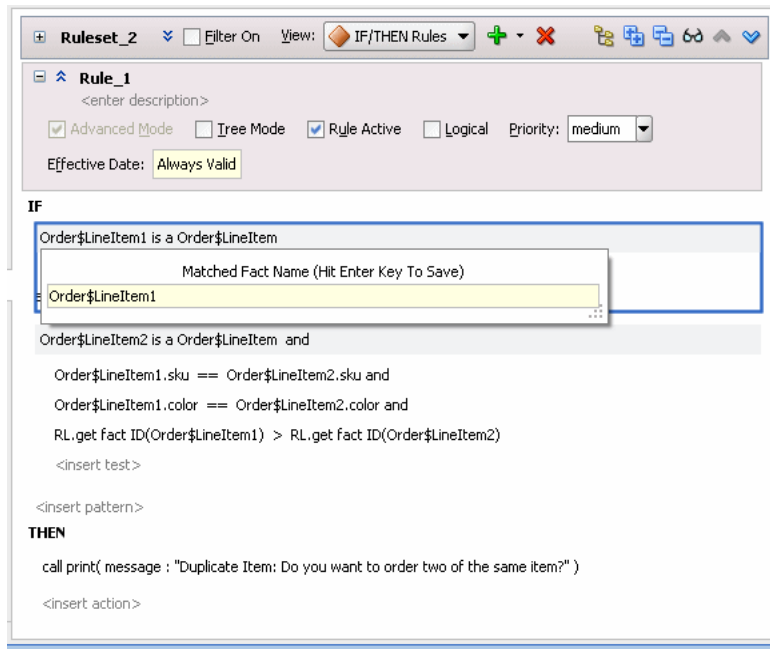
The matched fact name field, pattern binding variable, in a rule or a Decision Table lets you test multiple instances of the same type in a single rule. The matched fact name lets you enter a temporary name for the matched fact to use in a test. For example, the rules shown in [Figure 4–46](#) show the use of pattern binding variables in a rule that applies a discount on a shoe item when an order includes at least one "matching" hat item.

**Figure 4–46 Rule Using a Pattern Binding Variable**

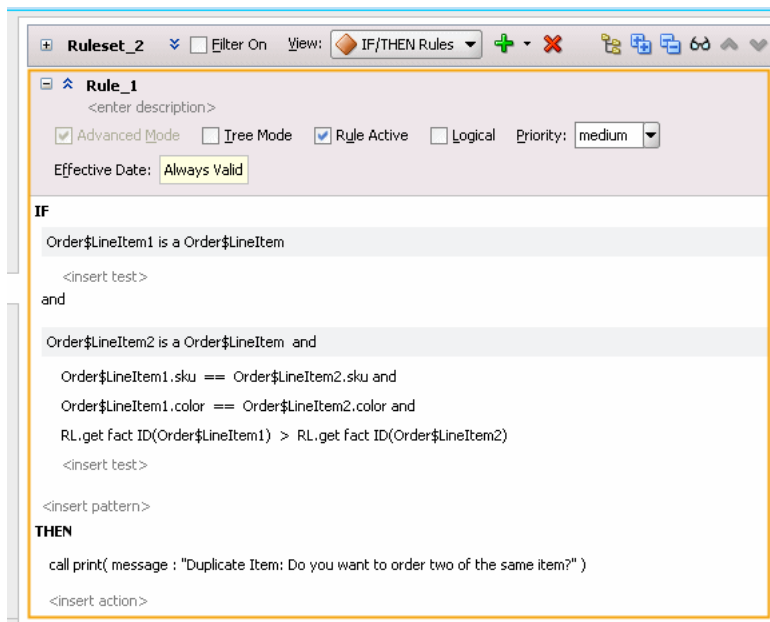
For example, you can create the rule, as shown in [Figure 4–47](#) to find duplicate items in a customer order. This example shows the use of matched in a rule.

**Figure 4–47 Rule to Find Duplicate Items in an Order****To use advanced mode matched fact naming:**

1. Select the rule or Decision Table where you want to add a matched fact name.
2. Click the **Show Advanced Settings** icon next to the rule name (see [Section 4.5.1, "How to Show and Hide Advanced Settings in a Rule or Decision Table"](#)).
3. Select **Advanced Mode**.
4. Select the **<fact type>** and enter a fact type from the list.
5. Select the supplied matched fact name and modify it as needed, as shown in [Figure 4–48](#). For example, enter the matched fact name `Order$LineItem1` and then press **Enter**.

**Figure 4–48 Adding a Matched Fact Variable Name**

6. Create the rule as [Figure 4–49](#) shows. Note that you can choose a matched fact name as an operand. Choose the `LineItem1` and `LineItem2` operands as needed to create the rule.

**Figure 4–49 Choosing a Matched Fact Variable Name as an Operand**

Note in [Figure 4–49](#) that the test checking:

```
RL.get fact ID(Order$LineItem1) > RL.get fact ID(Order$LineItem2)
```

Prevents a single instance of an `Order$LineItem` from matching both patterns that match the `Order$LineItem` fact type. The ">" is required so that the rule does not fire for different permutations of different instances. For more information, see



[Appendix C.4, "How Do I Correctly Express a Self-Join?"](#).

### 4.7.3 How to Use Advanced Mode Action Forms

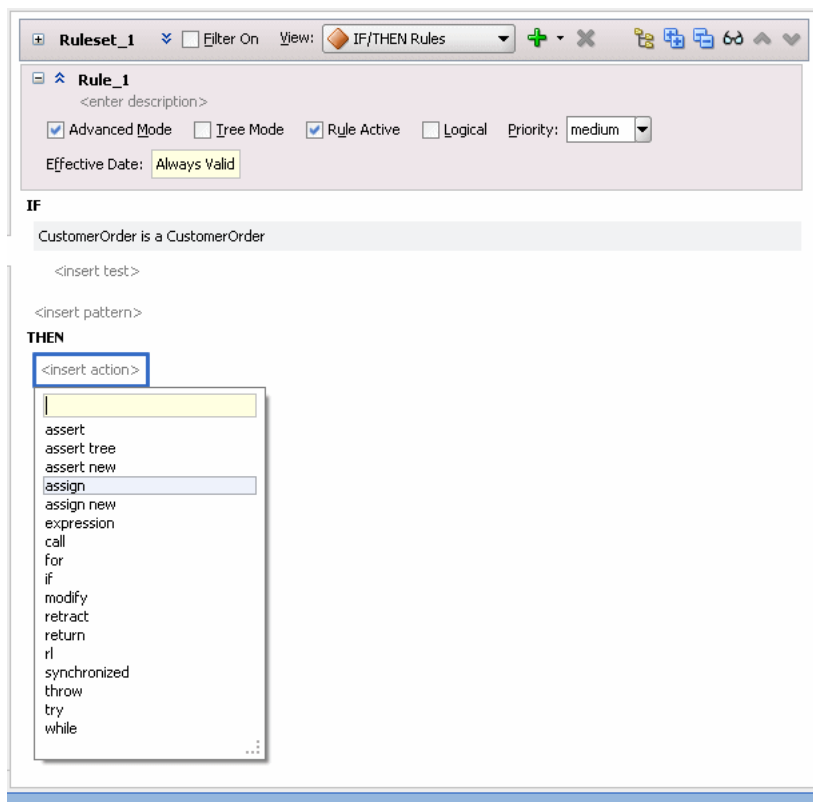
When you create a rule with **Advanced Mode**, Rules Designer presents a list with the available actions shown in [Table 4–6](#). For each form shown in [Table 4–6](#), the options that Rules Designer presents are context sensitive. Thus, the lists and the number of items you see when you work with the action types are context sensitive, depending on which action you add and the choices you make while you enter the action.

**Table 4–6** *Advanced Mode Action Options*

Action Form	Description
Assert	Assert a fact
Assert Tree	Asserts a tree of facts given the root.
Assert New	Assert a new fact.
Assign	Assign a value to a variable.
Assign New	Assign a value to a new variable.
Expression	Perform expression.
Call	Call a function.
For	Oracle RL, like Java, has a for loop. A for loop includes a type with a variable and a collection. The type and variable defines the loop variable that holds the collection value used within the loop. Collection is an expression that evaluates to a collection of the correct type for the loop variable. You can use a for loop to iterate through any collection.  A return, throw, or halt may exit the action block.
If	Using the if else action, if the test is true, execute the first action block, and if the test is false, execute the optional else part, which may be another if action or an action block. Oracle RL, unlike Java, requires action blocks and does not allow a single semicolon terminated action.
Modify	Modify a data value associated with a matched fact.
Retract	Retract a fact.
Return	The return action returns from the action block of a function or a rule. A return action in a rule pops the ruleset stack, so that execution continues with the activations on the agenda that are from the ruleset that is currently at the top of the ruleset stack.
rl	Use an Oracle RL expression that you supply.
synchronized	As in Java, the synchronized action is useful for synchronizing the actions of multiple threads. The synchronized action block lets you acquire the specified object's lock, then execute the action-block, then release the lock.
throw	Throw an exception, which must be a Java object that implements <code>java.lang.Throwable</code> . A thrown exception may be caught by a catch in a try action block.
try	The try, catch, and finally in Oracle RL is like Java both in syntax and in semantics. There must be at least one catch or finally clause.
while	While the test is true, execute the action block. A return, throw, or halt may exit the action block.

**To use advanced mode action forms:**

1. In Rules Designer, select a ruleset from the **Rulesets** navigation tab.
2. Select or add a rule or a Decision Table.
3. In the rule or Decision Table click the **Show Advanced Settings** icon next to the rule or Decision Table name (see [Section 4.5.1, "How to Show and Hide Advanced Settings in a Rule or Decision Table"](#)).
4. Select **Advanced Mode**.
5. With the insertion areas showing, in a rule in the **THEN** area select **<insert action>**. This displays the action list, as shown in [Figure 4-50](#).

**Figure 4-50 Adding an Action to a Rule in Advanced Mode**

6. In the list select the action you want to add.  
For example, select **assign new**.
7. In the **THEN** area, select the context sensitive parameters for the action and enter appropriate values.

#### 4.7.4 How to Use Advanced Mode Aggregate Conditions

When you create a rule with **Advanced Mode**, Rules Designer supports the pattern matching aggregate option. When you write rule conditions that are based not only on one fact, but on many facts, you can use an aggregate. You use aggregate functions when the conditions have a view spanning multiple facts.

[Table 4-7](#) shows the available aggregate functions.

**Table 4–7 Aggregate Functions for Advanced Mode Rules**

Function	Description
count	Count of matching facts.
average	Average of matching facts.
maximum	Maximum value of matching facts.
minimum	Minimum value of matching facts.
sum	Sum of matching facts.
collection	Builds a list of matching facts.

For example, to write a rule that specifies a special order as follows:

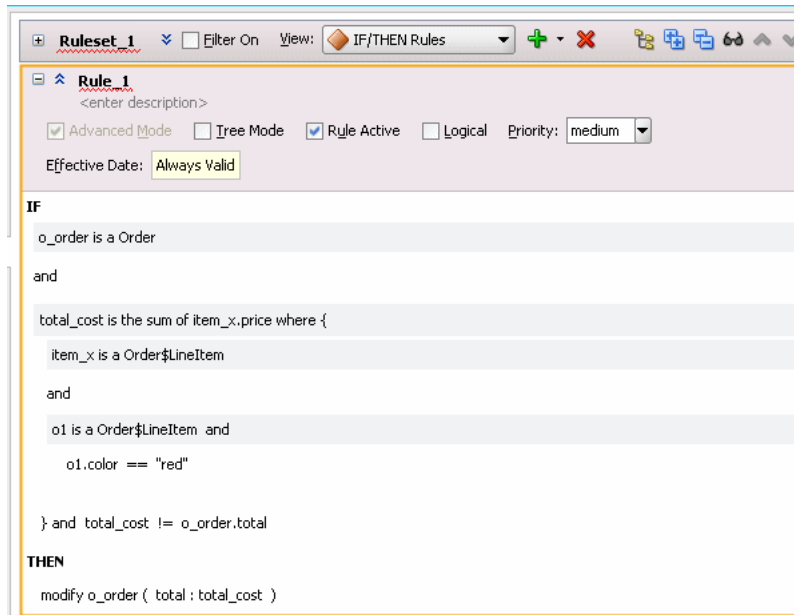
```
IF
    an order has more than 5 line items whose price is above a certain value
THEN
    the order requires manual approval
```

The five line items may span multiple facts. Thus, you can use the `count` aggregate function to write this sample special order rule.

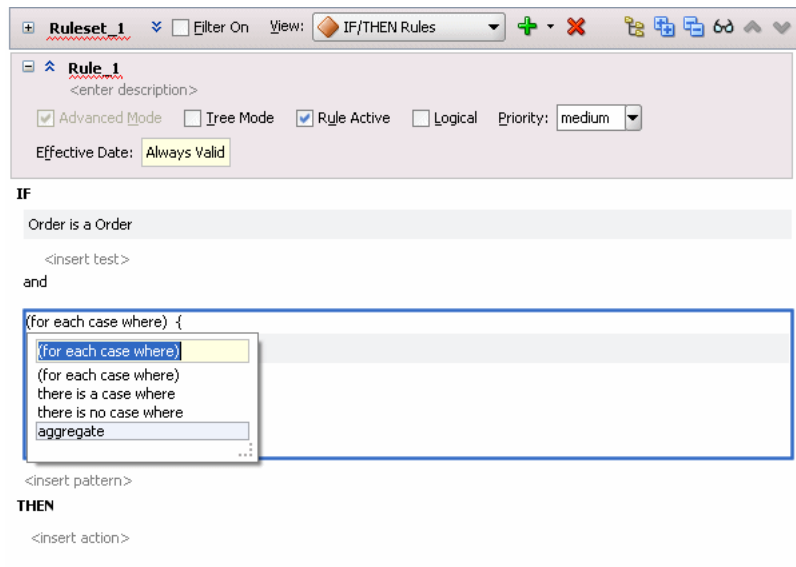
When you use an aggregate function, do the following:

- Select `aggregate` for the pattern.
- Enter a function from the list shown in [Table 4–7](#)
- Enter or select values from the context sensitive menus:
  - `<variable>` A name for the aggregate value.
  - `<expression>` The value to aggregate, for example `driver.age`. When the aggregate function you select is the `count` function the `<expression>` is not used.

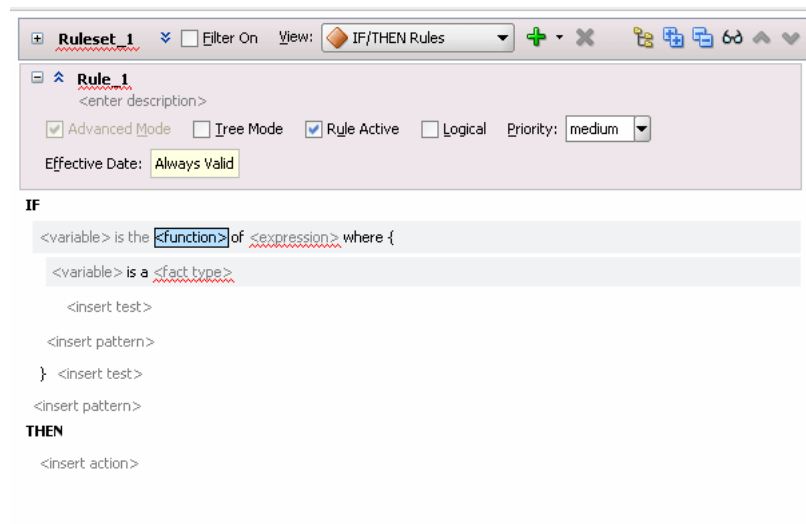
For example, you can compute the sum of the cost all the line items with color "red", as shown in [Figure 4–51](#).

**Figure 4–51 Using Aggregate Functions with Rules Red Color Total Cost Rule****To use advanced mode aggregates:**

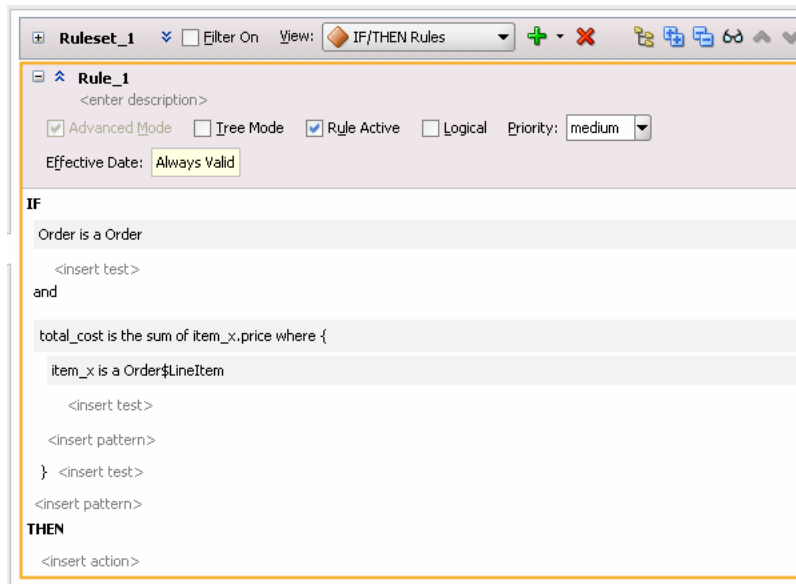
1. Select or create the rule or Decision Table where you want to use an aggregate function.
2. Click the **Show Advanced Settings** icon next to the rule or Decision Table name (see [Section 4.5.1, "How to Show and Hide Advanced Settings in a Rule or Decision Table"](#)).
3. Select **Advanced Mode**.
4. Enter the fact type you want to work with.
5. Select **<insert pattern>** to add a pattern.
6. Select the new pattern.
7. Right-click the pattern and select **Surround With....** This displays the Surround With dialog.
8. In the Surround With dialog select **Pattern Block**. For more information, see [Section 4.7.1, "How to Use Advanced Mode Pattern Matching Options"](#).
9. Click **OK**.
10. In the pattern select the first field. By default this field contains **(for each case where)**, as shown in [Figure 4–52](#).

**Figure 4–52 Adding an Advanced Pattern Match Option**

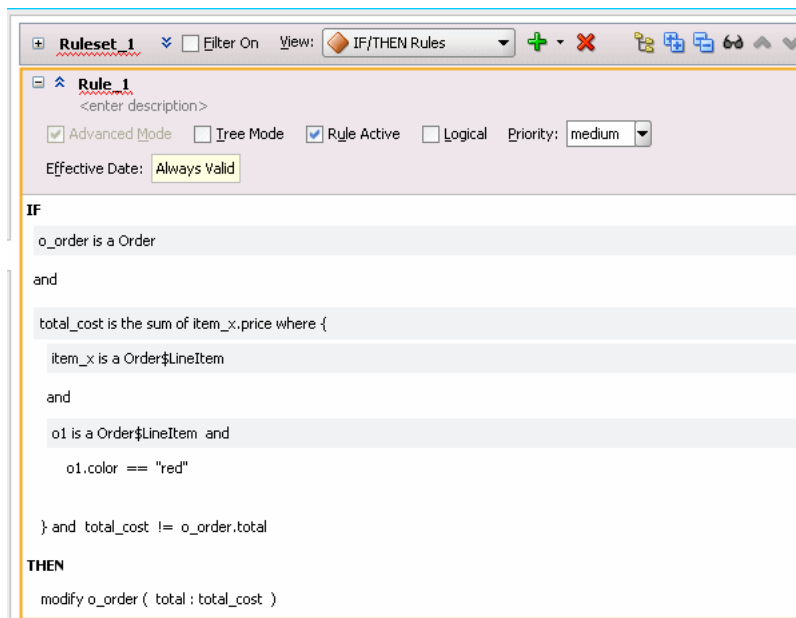
11. Select the **aggregate** option. This adds the context sensitive fields for an aggregate, as shown in [Figure 4–53](#).

**Figure 4–53 Using Aggregate Functions in a Rule**

12. Click **<function>** and select a function from the list.
13. In the condition, click **<fact type>** and select a fact type from the list.
14. Click **<expression>** and select an expression from the list.
15. Rules Designer by default constructs variable names as you create the aggregate pattern. If needed for the rule you are constructing enter variable names to replace the default variable names. [Figure 4–54](#) shows a completed rule using aggregate. In this example, for clarity the rule shows the variable names `total_cost` and `item_x`.

**Figure 4–54 Completed Aggregate Function in a Rule**

16. Enter additional tests as required. For this example you enter the test for items with color "red", as [Figure 4–55](#) shows.

**Figure 4–55 Using Aggregate Functions with Rules Red Color Total Cost Rule**

### 4.7.5 What You Need to Know About Advanced Mode Rules

There are some special cases to keep in mind when you work with **Advanced Mode** rules, including the following:

- When you work with aggregates, in actions, you do not see pattern variables. The pattern variables are only shown for action lists when you use (foreach...) patterns. Thus, you cannot see pattern variables in aggregate, "there is a case", or "there is no case patterns".

- After you select **Advanced Mode** the **Advanced Mode** stays selected and inactive (gray), as long as your rule uses advanced options such as advanced pattern matching. To deselect **Advanced Mode** you must remove or undo the advanced mode features (sometimes it is easier to start over by creating a non-advanced mode rule and then delete the advanced mode rule).

**To deselect the advanced mode option:**

1. Select the rule or Decision Table where you want to deselect **Advanced Mode**.
2. Click the **Show Advanced Settings** icon next to the rule or Decision Table name (see [Section 4.5.1, "How to Show and Hide Advanced Settings in a Rule or Decision Table"](#)).
3. Consider the state of the rule:
  - If you can simplify the rule to enable the **Advanced Mode** option (such that the **Advanced Mode** icon changes from gray to enabled). Then simplify the rule and when **Advanced Mode** is enabled, deselect **Advanced Mode**.
  - If you can use **Undo** to undo the steps you used to create the **Advanced Mode** rule, to get to a state where the rule is no longer in **Advanced Mode**, then use this technique to simplify the rule.
  - If you cannot simplify the rule, then delete the rule and re-create it.

## 4.8 Working with Tree Mode Rules

Tree Mode rules make it easier to work with a master detail hierarchy, where there are nested elements that map to a parent child relationship.

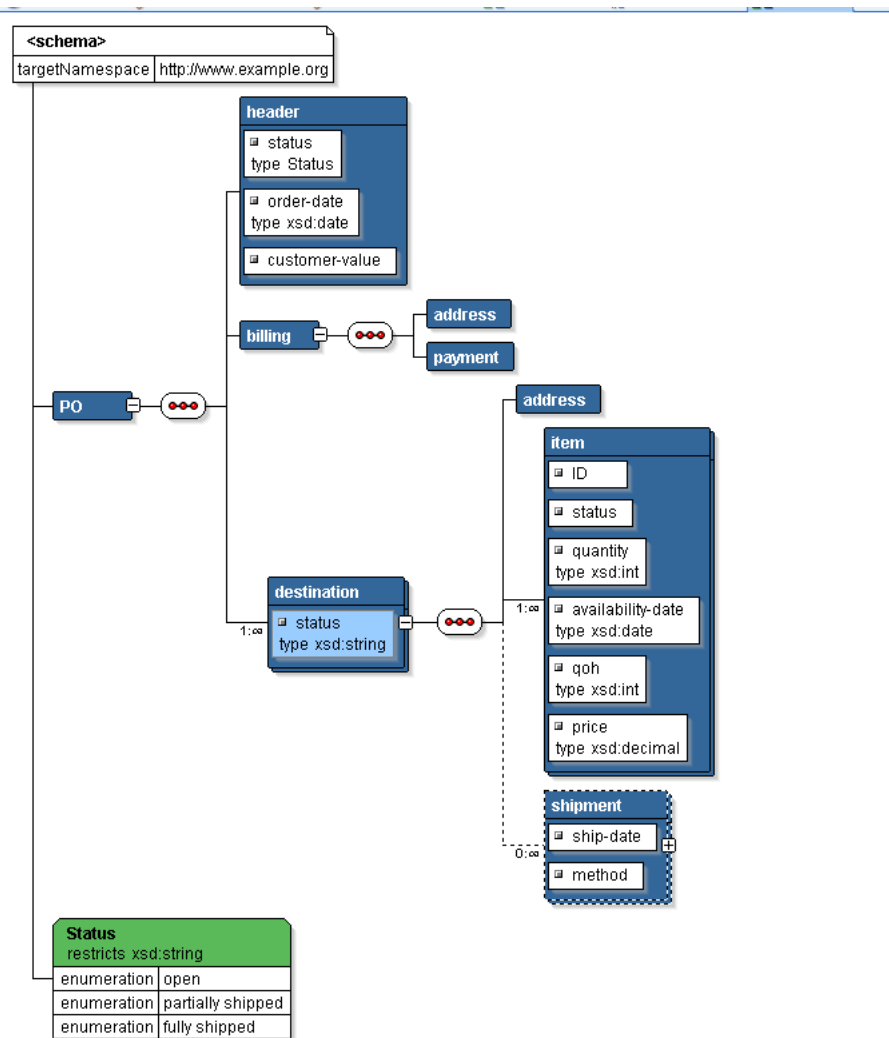
### 4.8.1 Introduction to Tree Mode Rules

To introduce tree mode rules, it is instructive to work with an example. Consider the lifecycle of an application fragment that uses business processes and rules to process a retail purchase order (PO). The purchase order has a header with business terms that apply to the entire PO. The PO also contains a list of shipping destinations. Each destination has an address, a list of items to be shipped to the destination's address, and a list of shipments.

Consider the business rule: the status of a PO is "fully shipped" if the status of every item is either "shipped" or "canceled".

[Figure 4–56](#) shows a sample XML schema representation for the PO example. The XML documents for the PO are tree structured. This allows a natural representation for the PO. For example, the PO itself is the top level document element and destinations are nested elements that contain item elements and shipment elements. Shipment elements also contain item elements that reference the ordered items. Status has a list of valid values.

Figure 4–56 PO Schema for Tree Mode Rules Sample



Example 4–1 shows the sample purchase order XML schema as represented in Figure 4–56.

#### Example 4–1 Sample Purchase Order (PO) Schema

```
<?xml version= '1.0' encoding= 'UTF-8' ?>
<xsd:schema xmlns:xsd="http://www.w3.org/2001/XMLSchema" xmlns="http://www.example.org"
targetNamespace="http://www.example.org"
elementFormDefault="qualified">
  <xsd:element name="PO">
    <xsd:annotation>
      <xsd:documentation>A sample element</xsd:documentation>
    </xsd:annotation>
    <xsd:complexType>
      <xsd:sequence>
        <xsd:element name="header">
          <xsd:complexType>
            <xsd:attribute name="status" type="Status"/>
            <xsd:attribute name="order-date" type="xsd:date"/>
            <xsd:attribute name="customer-value"/>
          </xsd:complexType>
        </xsd:element>
        <xsd:element name="billing">
          <xsd:sequence>
            <xsd:element name="address"/>
            <xsd:element name="payment"/>
          </xsd:sequence>
        </xsd:element>
        <xsd:element name="destination">
          <xsd:complexType>
            <xsd:attribute name="status" type="xsd:string"/>
          </xsd:complexType>
        </xsd:element>
        <xsd:element name="address">
          <xsd:sequence>
            <xsd:element name="item">
              <xsd:complexType>
                <xsd:attribute name="ID"/>
                <xsd:attribute name="status"/>
                <xsd:attribute name="quantity" type="xsd:int"/>
                <xsd:attribute name="availability-date" type="xsd:date"/>
                <xsd:attribute name="qoh" type="xsd:int"/>
                <xsd:attribute name="price" type="xsd:decimal"/>
              </xsd:complexType>
            </xsd:element>
            <xsd:element name="shipment">
              <xsd:complexType>
                <xsd:attribute name="ship-date"/>
                <xsd:attribute name="method"/>
              </xsd:complexType>
            </xsd:element>
          </xsd:sequence>
        </xsd:element>
      </xsd:sequence>
    </xsd:complexType>
  </xsd:element>
</xsd:schema>
```



```

</xsd:element>
<xsd:element name="billing">
  <xsd:complexType>
    <xsd:sequence>
      <xsd:element name="address" />
      <xsd:element name="payment" />
    </xsd:sequence>
  </xsd:complexType>
</xsd:element>
<xsd:element name="destination" maxOccurs="unbounded">
  <xsd:complexType>
    <xsd:sequence>
      <xsd:element name="address" />
      <xsd:element name="item" maxOccurs="unbounded">
        <xsd:complexType>
          <xsd:attribute name="ID" />
          <xsd:attribute name="status" />
          <xsd:attribute name="quantity" type="xsd:int" />
          <xsd:attribute name="availability-date" type="xsd:date" />
          <xsd:attribute name="qoh" type="xsd:int" />
          <xsd:attribute name="price"
            type="xsd:decimal" />
        </xsd:complexType>
      </xsd:element>
    </xsd:sequence>
    <xsd:element name="shipment" minOccurs="0" maxOccurs="unbounded">
      <xsd:complexType>
        <xsd:sequence>
          <xsd:element name="item" maxOccurs="unbounded">
            <xsd:complexType>
              <xsd:attribute name="ID" />
              <xsd:attribute name="quantity" />
            </xsd:complexType>
          </xsd:element>
        </xsd:sequence>
        <xsd:attribute name="ship-date" />
        <xsd:attribute name="method" />
      </xsd:complexType>
    </xsd:element>
  </xsd:sequence>
  <xsd:attribute name="status" type="xsd:string" />
</xsd:complexType>
</xsd:element>
</xsd:sequence>
</xsd:complexType>
</xsd:element>
<xsd:simpleType name="Status">
  <xsd:restriction base="xsd:string">
    <xsd:enumeration value="open" />
    <xsd:enumeration value="partially shipped" />
    <xsd:enumeration value="fully shipped" />
  </xsd:restriction>
</xsd:simpleType>
</xsd:schema>

```

**Example 4-2** shows part of the XML for an instance of the PO schema. To use tree mode rules you can create a rule that tests one or more business terms and if the tests pass, one or more business terms are added or changed. Oracle Business Rules has special support to enable error-free authoring of rules on fact trees like the sample PO instance.

For example, consider creating a rule for an instance of the PO schema that states:

IF the time between the order date and the date for availability of an item is more than 30 days  
THEN cancel the item

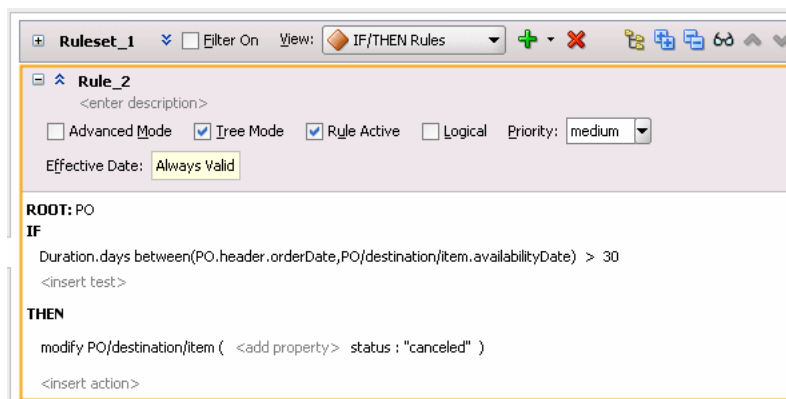
#### Example 4–2 Sample Abbreviated PO XML Instance

```
<PO xmlns:xsi="http://www.w3.org/2001/XMLSchema-instance"
  xsi:schemaLocation="http://www.example.org ../../../../Temp/PO.xsd"
  xmlns="http://www.example.org">
  <header/>
  <billing>
    <address/>
    <payment/>
  </billing>
  <destination>
    <address/>
    <item ID="a01"/>
    <item ID="a02"/>
    <item ID="a03"/>
    <shipment>
      <item ID="a01"/>
      <item ID="a02"/>
    </shipment>
  </destination>
</PO>
```

#### 4.8.1.1 Understanding Tree Mode Rules (Non-Advanced Mode)

You use non-advanced tree mode, or simple tree mode, when the **Advanced Mode** option is not selected and **Tree Mode** is selected. With this mode Rules Designer shows **ROOT: <fact type>** where you enter the root fact type, as shown in [Figure 4–57](#).

Figure 4–57 Simple Tree Mode Rule with Tree Mode Selected



When you create rules with **Tree Mode** selected and **Advanced Mode** unselected you can reference properties in the tree using qualified names, for example:

- PO/destination/item.quantity that is similar to item.quantity but only items that are a destination of PO are matched.
- PO\$Destination\$item.quantity that refers to a List<item>. This reference is unchanged from non-tree mode.

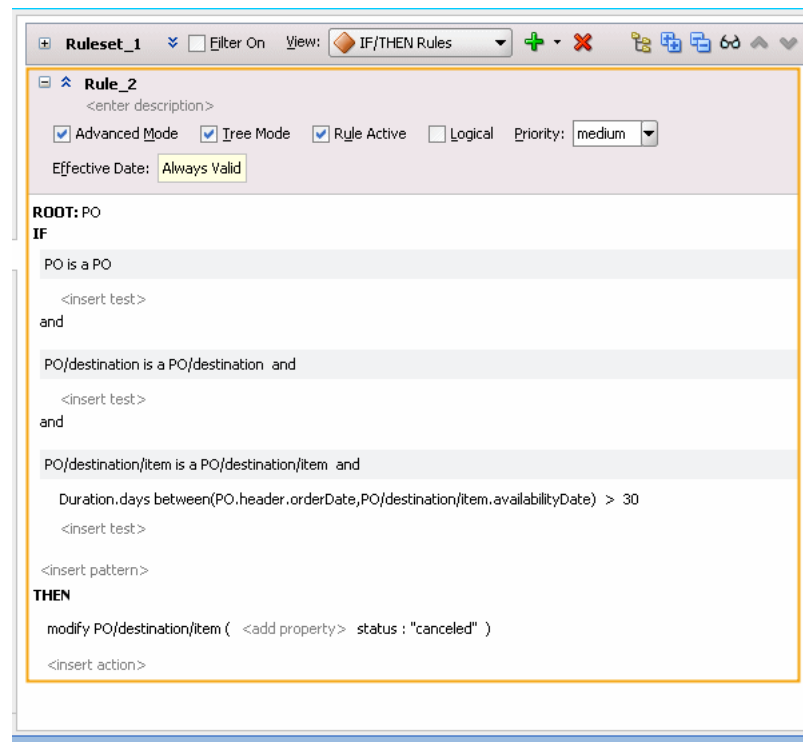
With Simple Tree Mode you can only choose terms that do not require many-to-many joins or aggregation.

For more information, see [Section 4.8.2, "How to Create Simple Tree Mode Rules"](#).

### 4.8.1.2 Understanding Advanced Tree Mode Rules

You use advanced tree mode when the **Advanced Mode** option is selected and the **Tree Mode** option is selected. With this mode Rules Designer shows **ROOT: <fact type>** where you enter the root fact type, as shown in [Figure 4–58](#). Rules Designer shows patterns for the tree structured facts but the simple tests that join the parent and child facts are hidden.

**Figure 4–58** *Advanced Tree Mode*



In advanced tree mode the tree mode patterns, except for the root, display as:

```
<operator> <variable> is a <fact path>
```

Where the <fact path> is an XPath-like path through the 1-to-1 and 1-to-many relationships starting at the root. For example, each fact path has a name like PO/destination, where PO is the root fact type and the destination is a property of type List. A 1-to-many relationship in a fact path is indicated with a "/", as in PO/destination.

A 1-to-1 relationship in a fact path is indicated with "." This unchanged from non-tree mode. For example, item.availabilityDate.

Advanced mode exposes the concept of a pattern, the simplest of which is **is a**. For example, **p is a PO** causes **p** to match, iterate over, all the PO facts, and **d is a p/destination** causes **d** to match all the destinations of **p**. The left side of **is a** is a variable, and the right side is a fact type or a fact path. By default, Oracle Business Rules sets the variable name equal to the fact type or path. For example, **PO is a PO**. A

pattern can also be a pattern block. A pattern block has a logical quantifier, negation, or aggregation that applies to the patterns and tests nested inside the block.

For more information, see [Section 4.8.3, "How to Create Advanced Tree Mode Rules"](#).

When you work with advanced tree mode rules, Rules Designer expects you to use an aggregation pattern, including exists and not exists to combine terms from different child forests into the same rule while avoiding a Cartesian product.

## 4.8.2 How to Create Simple Tree Mode Rules

Given the XML schema shown in [Example 4-1](#) and the schema instance shown in [Example 4-2](#), the following procedure creates the PO rule to cancel non 30-day availability items.

```
IF the time between the order date and the date for availability of an item is
more than 30 days
THEN cancel the item
```

### To create simple tree mode rules:

1. Create an IF/THEN rule in your ruleset.

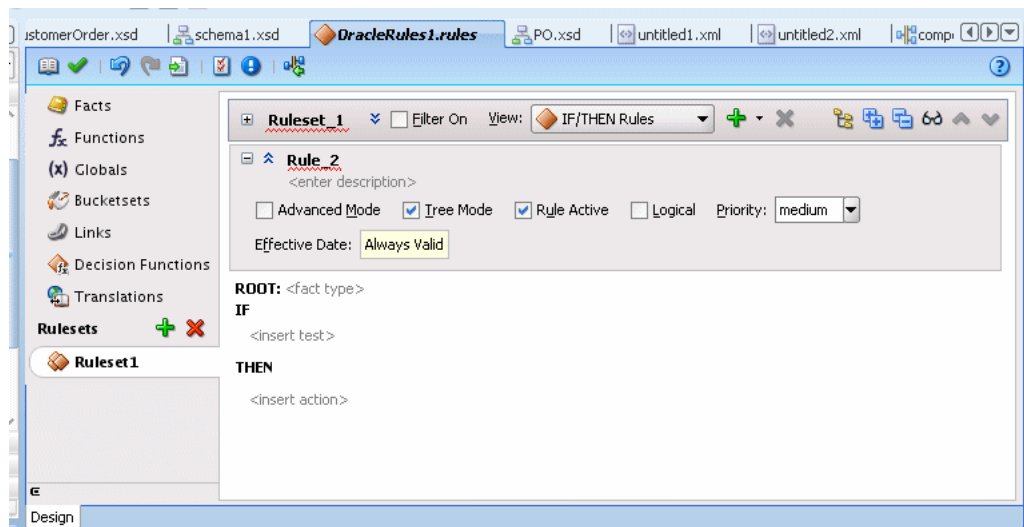
For more information, see [Section 4.3.1, "How to Add Rules"](#).

2. View advanced settings.

For more information, see [Section 4.5.1, "How to Show and Hide Advanced Settings in a Rule or Decision Table"](#).

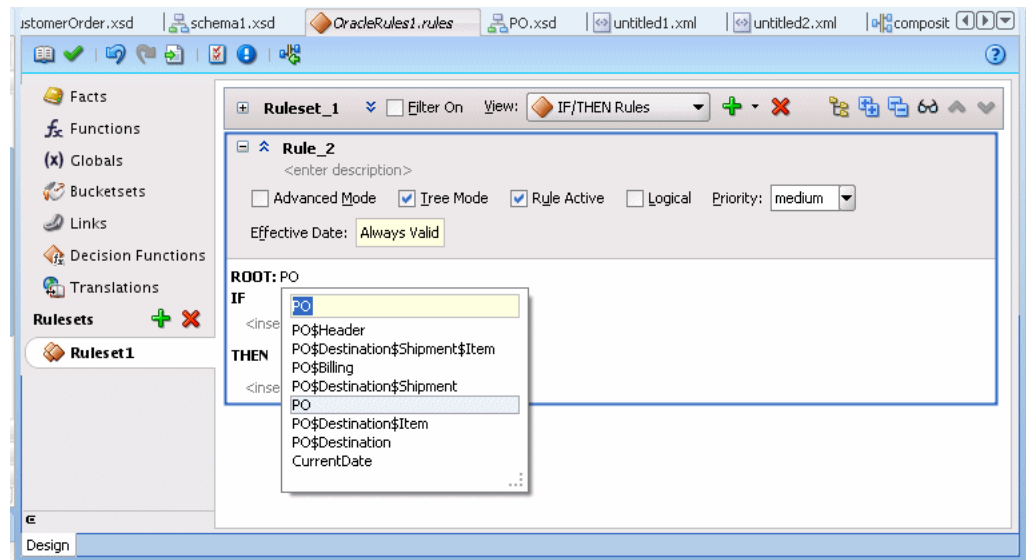
3. Select **Tree Mode** as [Figure 4-59](#) shows.

**Figure 4-59 Simple Tree Mode Advanced Settings**



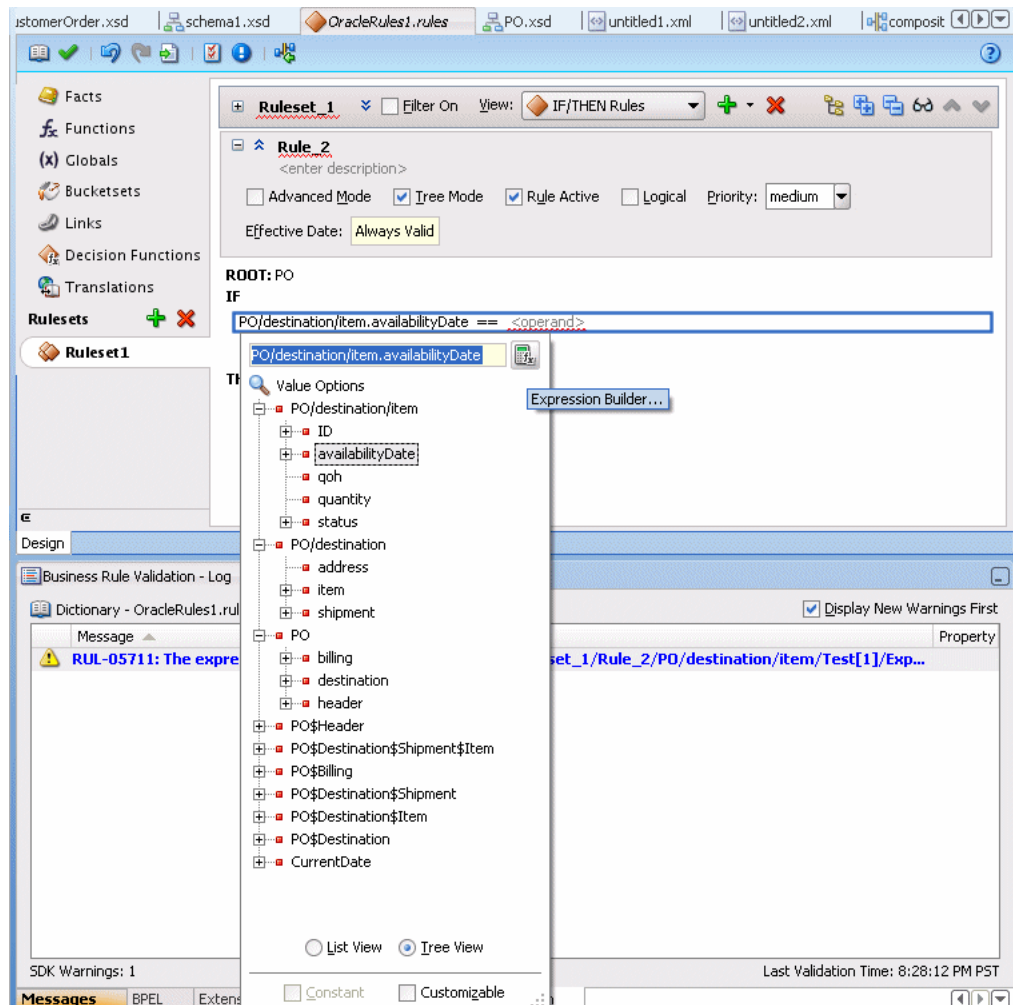
4. Next to **ROOT:**, click the **<fact type>** place holder and select **PO** from the list as [Figure 4-60](#) shows.

Figure 4–60 Simple Tree Mode: Configuring the Root

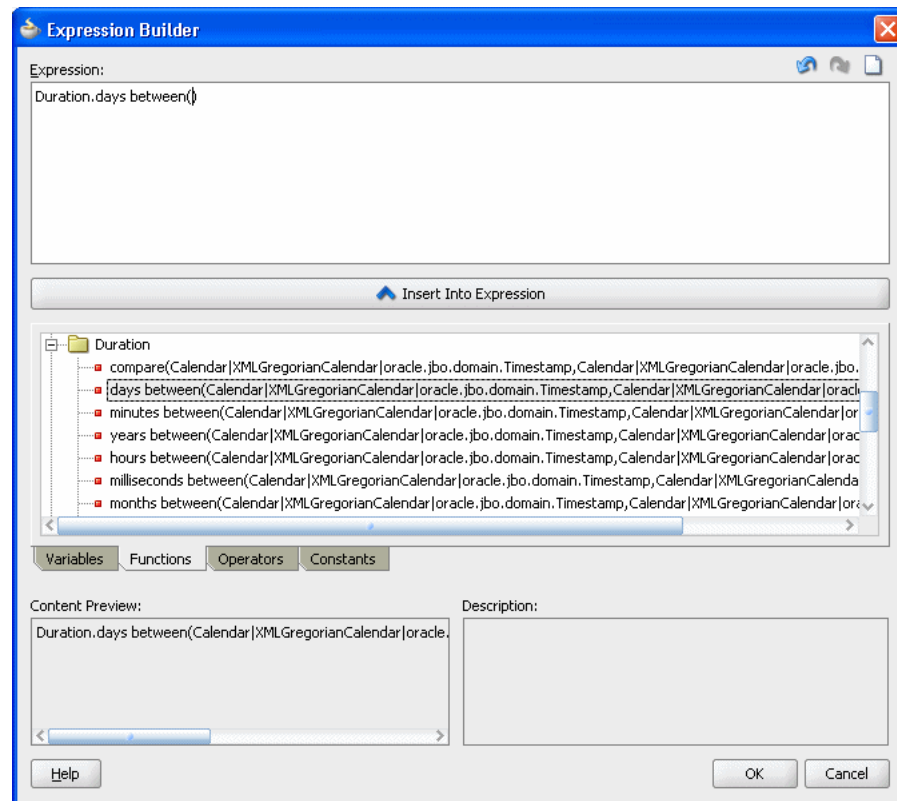


5. Select **<insert test>**.  
The IF statement now reads IF **<operand> == <operand>**.
6. Select the left-hand **<operand>**.
7. In the list, select PO/destination/item.availabilityDate.
8. Select **Expression Builder** icon, as shown in [Figure 4–61](#).

Figure 4-61 Adding Simple Tree Mode Expression

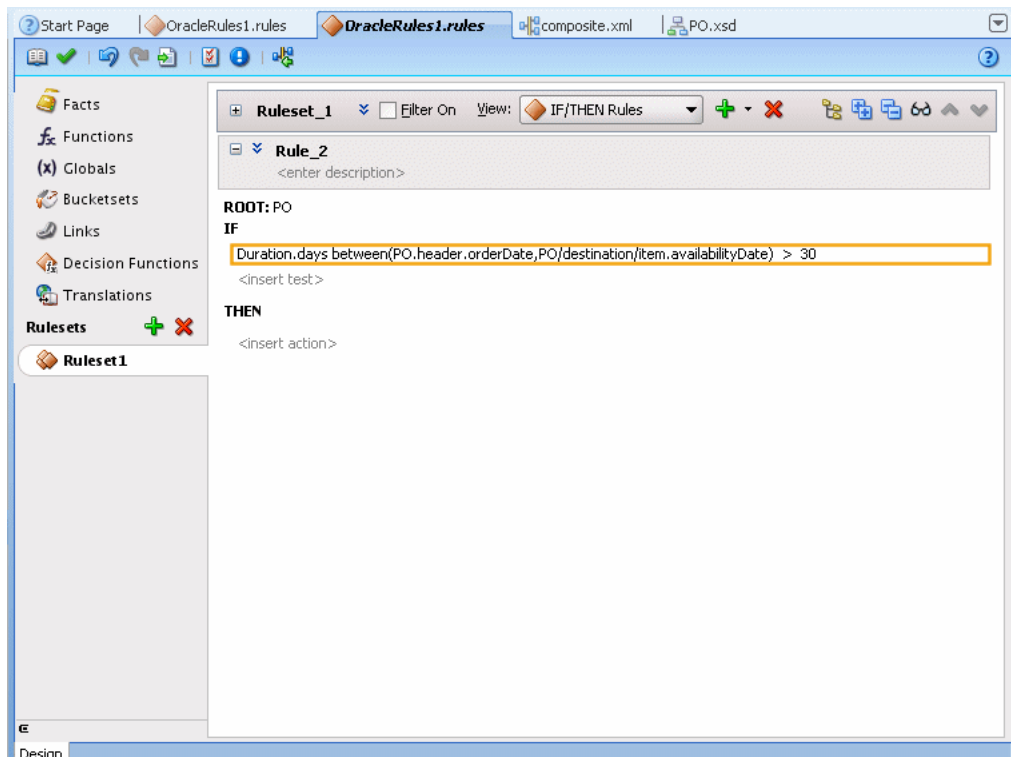


9. In the Expression Builder dialog, copy and delete the item shown in the Expression area.
10. In the Expression Builder, select the **Functions** tab.
11. In the navigator, expand **Duration** and double-click the **daysbetween** function.
12. Remove the **daysbetween** argument templates, as shown in Figure 4-62.

**Figure 4–62 Using Expression Builder to Add a Simple Tree Mode Rule**

13. In the **daysbetween** function, paste the value you previously cut as the second argument.
14. In the Expression Builder dialog, select the **Variables** tab.
15. For the **daysbetween** function first argument, use the navigator to expand **PO** and expand **header**, and double-click **orderDate**.
16. In the Expression Builder dialog, click **OK**.
17. In the list, in the expression area and press **Enter**.
18. Select the operator and enter **>**.
19. Select the right-hand **<operand>** and enter the value 30 and press **Enter**, as shown in [Figure 4–63](#).

Figure 4–63 Simple Tree Mode: Right-Hand Operand with Value 30



20. Click **<insert action>** and from the list select **modify**.

The THEN statement now reads: THEN modify <target>.

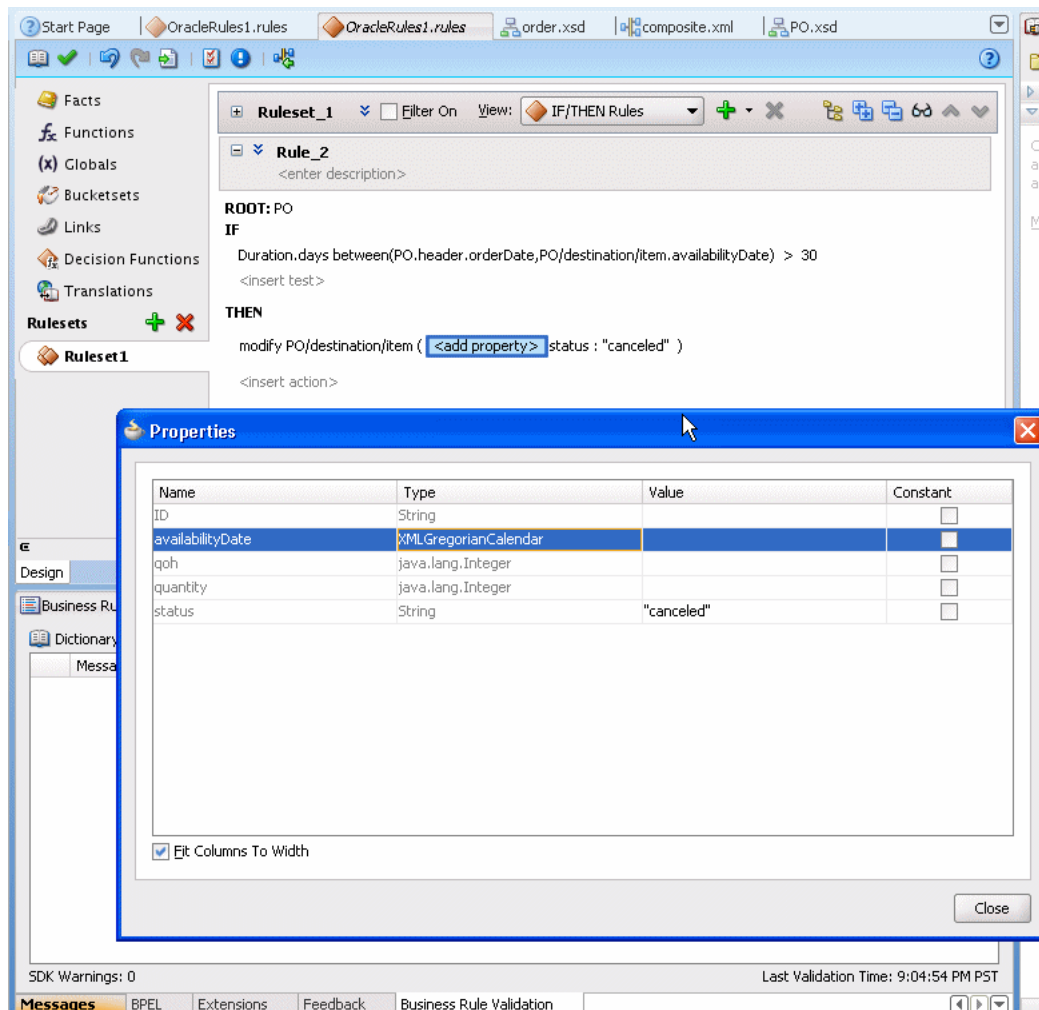
21. Click **<target>** and from the list select PO/destination/item. The THEN statement now reads:

```
THEN modify PO/destination/item ( <add property> )
```

22. Click **<add property>**. This displays the properties dialog.
23. In the properties dialog for the status name, enter the value "canceled", as [Figure 4–64](#) shows.

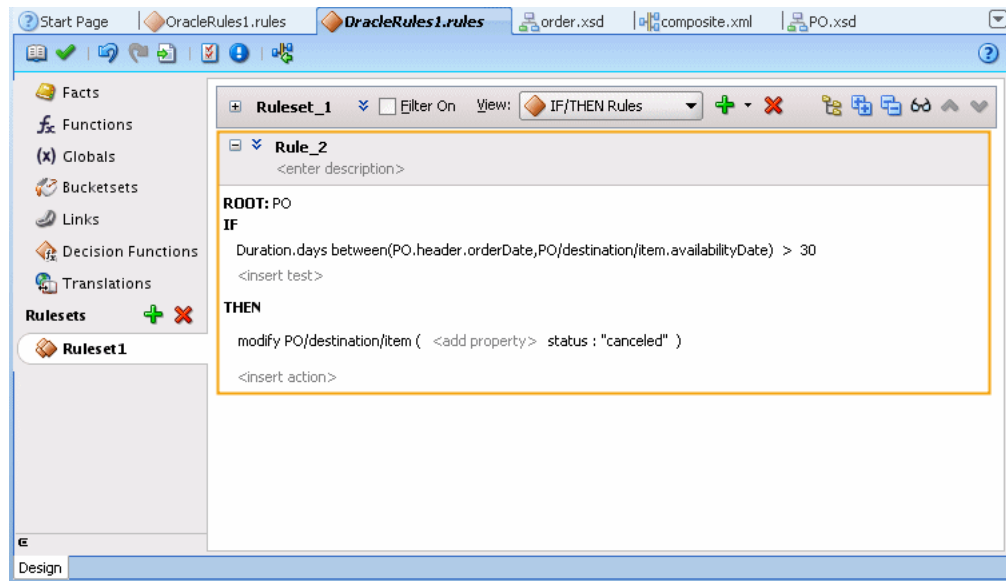


Figure 4–64 Simple Tree Mode: Action



24. In the Properties dialog, click **Close**.

25. This displays the finished rule, as shown in [Figure 4–65](#).

**Figure 4–65 Simple Tree Mode Rule Final Rule**

Note that in the modify statement, `PO/destination/item` refers to the particular item instance member.

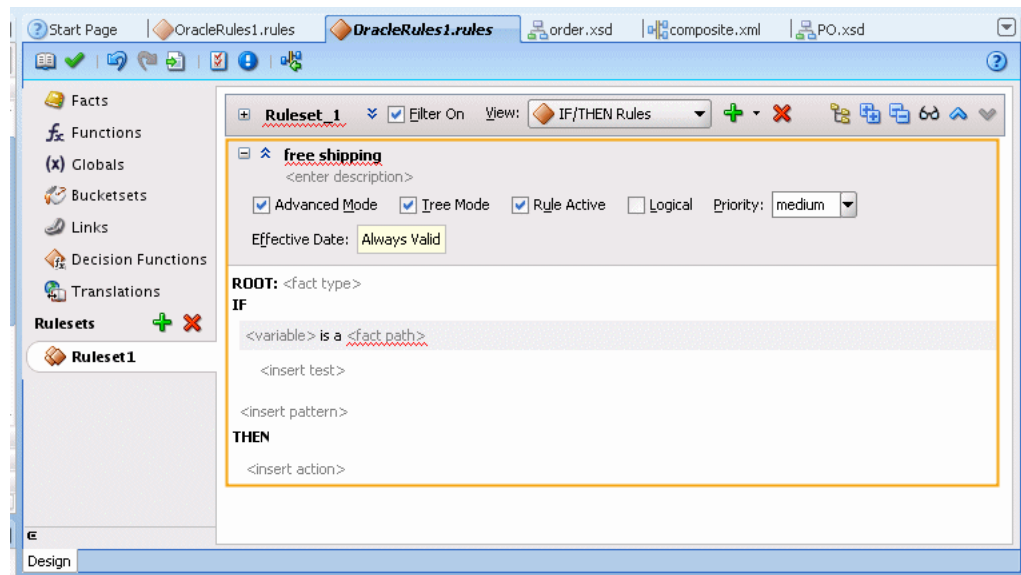
### 4.8.3 How to Create Advanced Tree Mode Rules

Given the XML schema shown in [Example 4–1](#) and the instance of these facts shown in [Example 4–2](#), the following procedure creates a free shipping rule that can be summarized as:

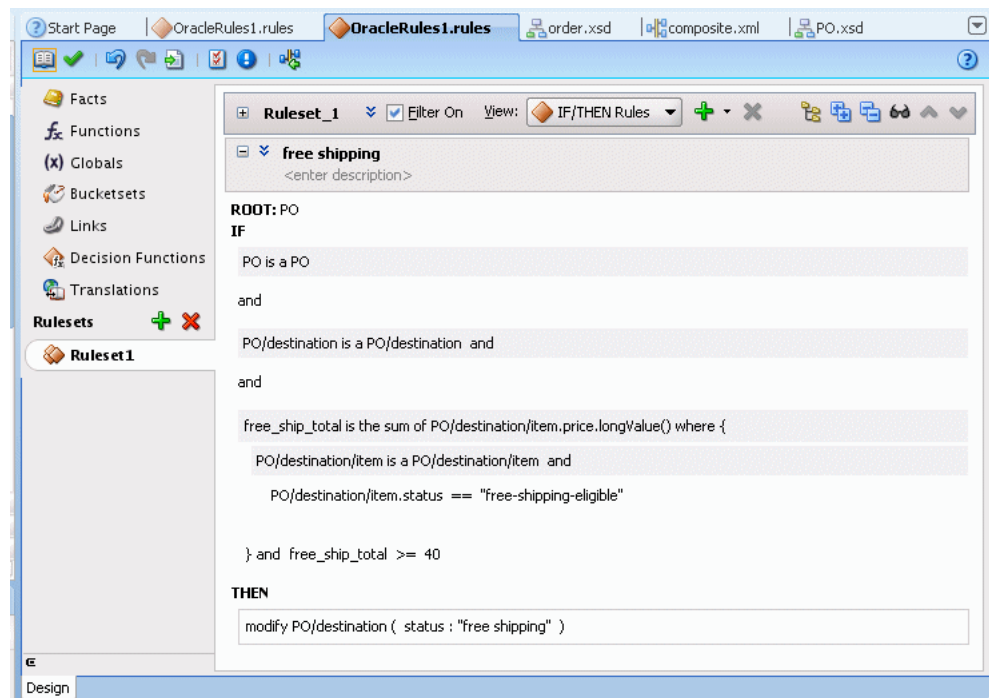
```
IF the total cost of "free shipping eligible" items to a given destination is
greater than $40
THEN shipping of those items is free
```

#### To create advanced tree mode rules:

1. Create an IF/THEN rule in your ruleset.  
For more information, see [Section 4.3.1, "How to Add Rules"](#).
2. View advanced settings.  
For more information, see [Section 4.5.1, "How to Show and Hide Advanced Settings in a Rule or Decision Table"](#).
3. Select **Advanced Mode** and select **Tree Mode** as [Figure 4–66](#) shows.

**Figure 4–66 Advanced Tree Mode Rule for Free Shipping**

4. Select the **<fact type>** place holder and from the list, select **PO**.
5. Complete the free shipping rule, as shown in [Figure 4–67](#).

**Figure 4–67 Advanced Tree Mode Free Shipping Rule**

#### 4.8.4 What You Need to Know About Tree Mode Rules

When you select **Tree Mode** and select a root fact type, the options lists show all available fact types (not just the children of the root fact type). This allows you to view all available fact types as well as the children of the root fact type. There is no option to limit the option list to only show the children of the selected root fact type.

## 4.9 Using Date Facts, Date Functions, and Specifying Effective Dates

Oracle Business Rules provides functions that make it easier for you to work with times and dates, and provides effective date features to let you determine when rules are effective, based on times and dates:

- The **CurrentDate** fact allows you to reason on a fact representing the current date.
- The **Effective Date** value lets you specify a start date and end date that defines a date or date and time range when all the rules and Decision Tables in a ruleset, an individual rule, or an individual Decision Table are effective.

Table 4–8 describes the available **Effective Date** options.

**Table 4–8 Effective Date Possible Values**

Effective Date	Description
Always Valid	Specifies to set neither "From" nor "To" dates.
From (without To date set)	Valid from a certain date indefinitely into the future.
To (without a From date set)	Valid from now until a certain date.
From Set and To set	Valid only between two dates.

An effective date specification other than **Always** can be one of the following:

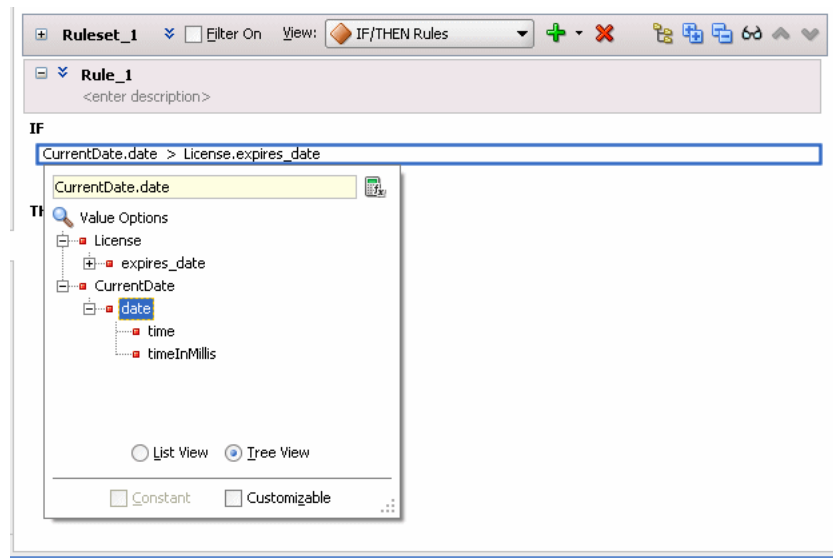
- Date only, with no time specification: In this case, an effective date assumes a time of midnight of that date in each time zone.
- Date, time zone, with no time specification: In this case, an effective date assumes a time of midnight as of the specified date in the specified time zone.
- Date, time zone, time specification: In this case, the date and time is fully specified.
- Time specification only, with no date and no time zone: applies for all days at the specified time.
- Time and time zone specified, with no date: applies for all days at the specified time.

### 4.9.1 How to Use the Current Date Fact

You can use the current date fact in a rule or a Decision Table.

**To use the CurrentDate fact:**

1. Select a ruleset from the **Rulesets** navigation tab.
2. Select a rule within the ruleset.
3. In the **IF** area, add a condition that uses the CurrentDate fact and the date method of Calendar type, as shown in Figure 4–68.

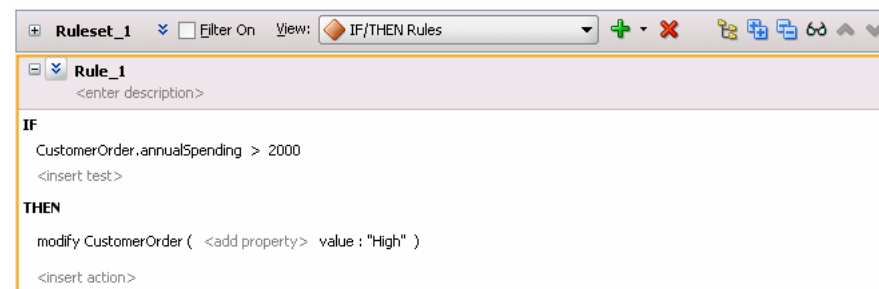
**Figure 4–68 Rule with Condition Using CurrentDate Fact**

## 4.9.2 How to Set the Effective Date for a Rule

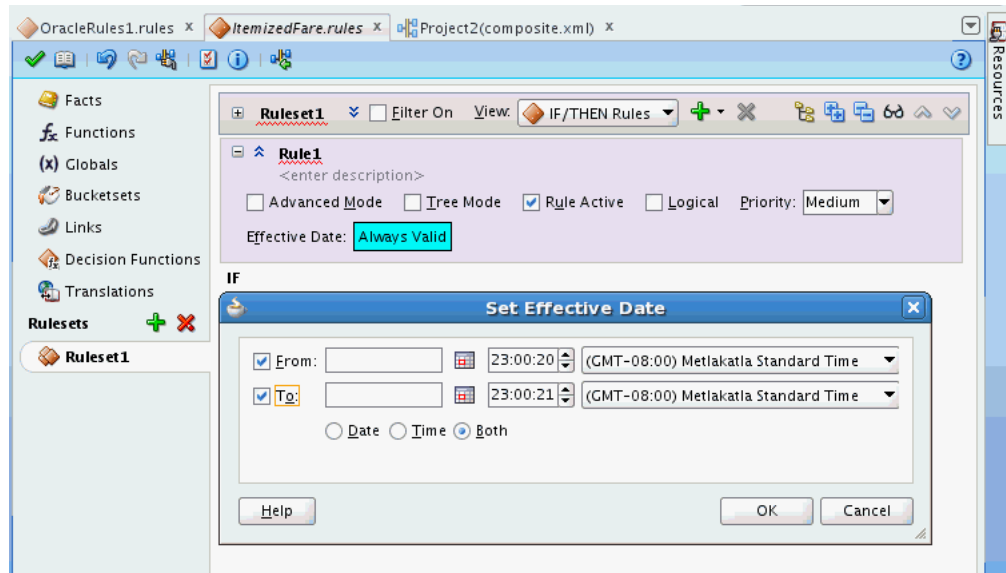
You can specify an effective start date and or an effective end date for a ruleset, a rule, or a Decision Table. For information on specifying the effective date for a ruleset, see [Section 4.2.2, "How to Set the Effective Date for a Ruleset"](#).

### To set the effective date for a rule:

1. Select the ruleset name from the **Rulesets** navigation tab.
2. Select a rule within the ruleset.
3. Next to the rule name click **Show Advanced Settings**, as shown highlighted in [Figure 4–69](#).

**Figure 4–69 Showing Advanced Settings in a Rule**

4. Select the **Effective Date** field. This displays the Set Effective Date dialog, as shown in [Figure 4–70](#).

**Figure 4–70** Setting the Effective Date for a Rule

5. Use the Set Effective Date dialog to specify the effective dates for the rule. Clicking the **Set Date** icon displays a calendar to assist you in entering the **From** and **To** field data.
6. In the Set Effective Date dialog, click **OK**.

### 4.9.3 What You Need to Know About Effective Dates

By default, the Oracle Business Rules Engine implicitly manages the clock associated with the `CurrentDate` fact and the effective date, setting each to the value of the system date. Using the RL Language functions `setCurrentDate()` and `setEffectiveDate()` you can explicitly set the current date and the effective date. For more information, see *Rules Language Reference for Oracle Business Process Management*.

An effective start date is defined as the first point in time at which a rule, Decision Table, or ruleset may actively participate in rule evaluations and fire. Thus, if a rule is effective it may fire if its condition is satisfied and if the rule is not effective, it does not fire whether the condition is satisfied or not.

An effective end date is the first moment in time at which the rule, Decision Table, or ruleset no longer actively participates in rule evaluations (not effective means the rule does not fire).

The effective start and end date can be set on a Decision Table, but these dates cannot be set individually for the rules within a Decision Table.

Rules and Decision Tables also include the **Rule Active** option. This option is set independent of the effective dates and makes dates effective without changing or removing the specified effective date. For more information on using the **Rule Active** option, see [Section 4.5.3, "How to Select the Active Option"](#).

The precedence of the effective date, when it is defined for both a ruleset and for the rules or Decision Tables within a ruleset, is as follows (with the top precedence being 1):

1. If the ruleset **Rule Active** option is unselected, then RL Language is not generated for that entity.

2. If one or both of the effective date properties are selected for a ruleset, then those effective start dates and effective end dates define the range of effective dates allowable for rules or Decision Tables that are defined within the ruleset (that is, if in the ruleset the **From** checkbox, the **To** checkbox, or both checkboxes are selected in the Set Effective Date dialog).

Thus, the effective dates specified for rules or Decision Tables within a ruleset must not violate the boundaries established by the ruleset that contains the rules or Decision Tables. For example, a rule may not have an effective end date that is later than the effective end date specified for a ruleset.

3. If any individual rule or Decision Table has **Rule Active** unselected, then RL Language is not generated for that rule or Decision Table.
4. If the Set Effective Date dialog for a ruleset includes **Time** selected or this option is selected on a rule or a Decision Table in the ruleset, then all instances of rules or Decision Tables in the ruleset must have **Time** selected when effective dates are specified. In this case, if **Both** or **Date** is selected then Rules Designer shows a validation warning:

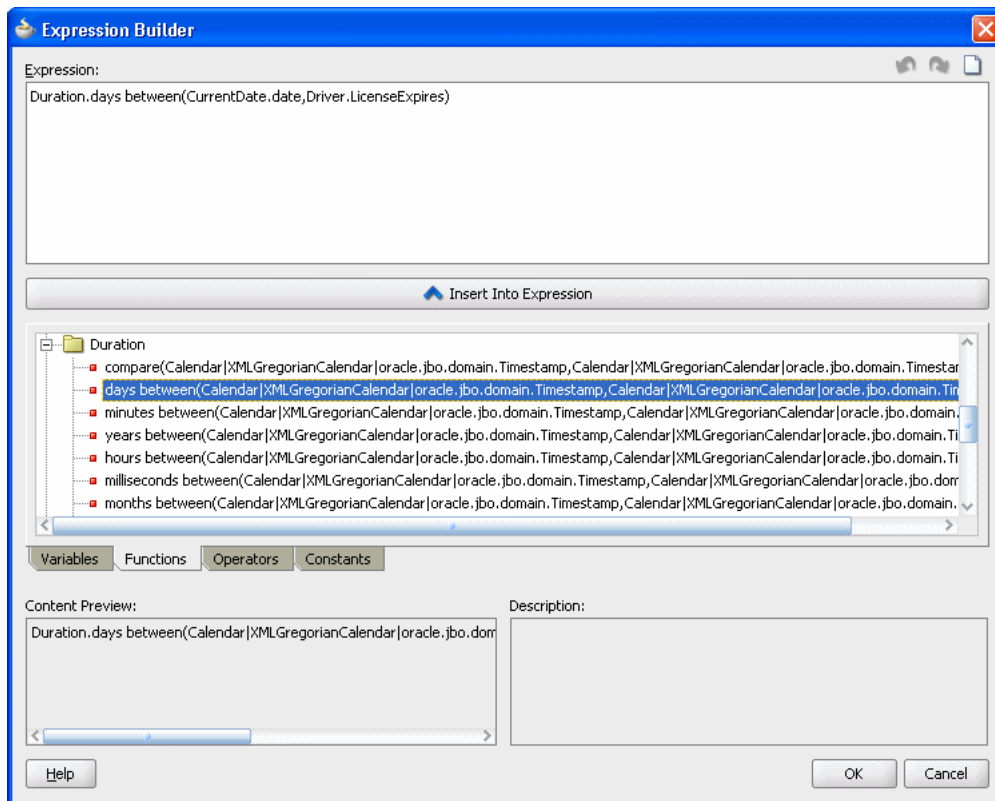
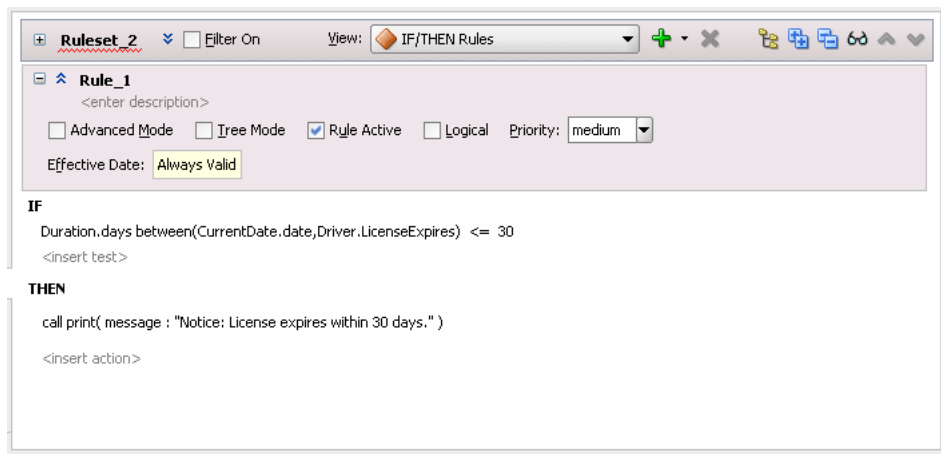
RUL-05742: Calendar form incompatibility detected with forms Time and DateTime. If the calendar form is set to Time on a rule set or any of the rules or decision tables within that ruleset then the calendar form for that entire rule set is restricted to Time.

#### 4.9.4 How to Use Duration, JavaDate, OracleDate, and XMLDate Methods

You can use the Duration, JavaDate, and XMLDate, OracleDate, and OracleDuration extension methods in a rule or a Decision Table. For more information, see [Appendix B, "Oracle Business Rules Built-in Classes and Functions"](#).

##### To use a Duration method:

1. Select ruleset from the **Rulesets** navigation tab.
2. Select a rule within the ruleset (you can also use Duration methods in a Decision Table).
3. In the **IF** area, add a condition.
4. Select an operand in the rule condition.
5. From the list, select **Expression Builder....** For more information, see [Section 4.10, "Working with Expression Builder"](#).
6. In the Expression Builder, select the **Functions** tab.
7. In the Expression Builder, in the Navigator, expand the **Duration** folder.
8. Double-click to select and insert the appropriate method as needed for your duration test.
9. Provide the appropriate arguments for the method. For example, see [Figure 4-71](#).
10. This allows you to create a rule such as that shown in [Figure 4-72](#).

**Figure 4–71 Using Duration Methods in a Rule****Figure 4–72 Adding a Rule Using Duration Function**

## 4.10 Working with Expression Builder

Use the expression builder to create and edit expressions for Oracle Business Rules.

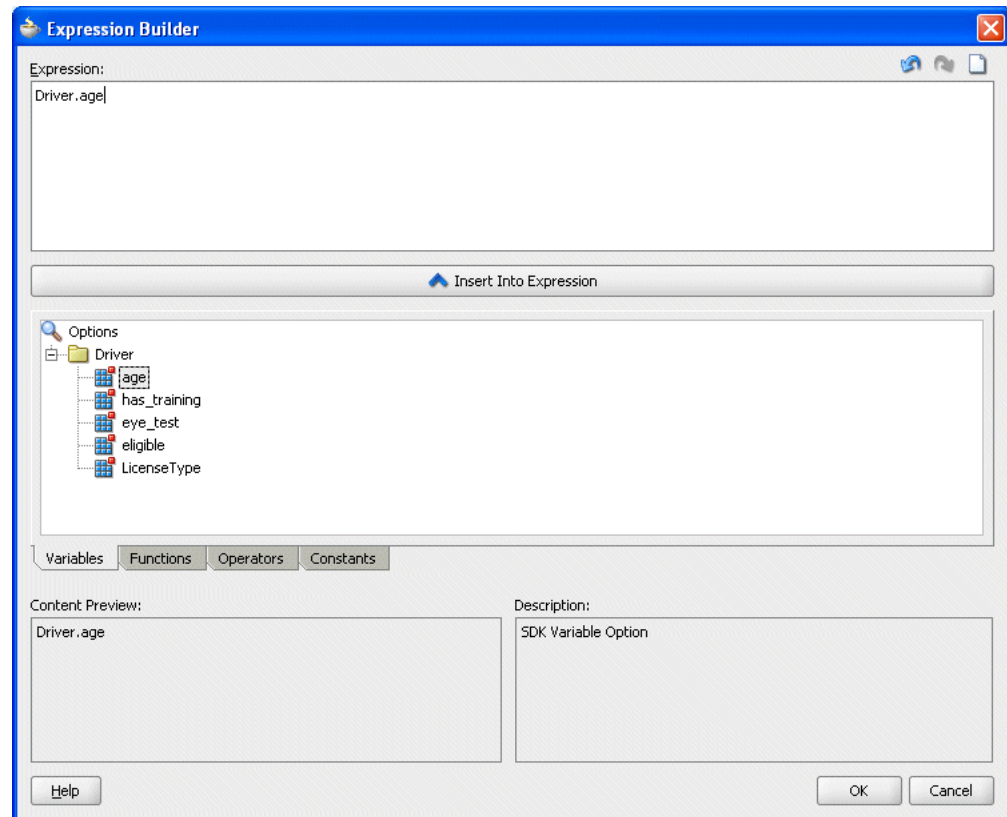
### 4.10.1 Introduction to the Expression Builder

You can access the expression builder from different parts of Rules Designer, including in the Edit Globals dialog, and in the conditions area when you work with conditions in Decision Tables, and when you enter rules and Decision Tables in advanced mode with free form expressions selected.



Figure 4–73 shows the Rules Designer expression builder.

**Figure 4–73 Rules Designer Expression Builder**



### 4.10.2 How to Use the Expression Builder

In the expression builder when you double-click items in the **Variables** or **Functions** navigation trees, or in the **Operators** tab, or in the **Constants** tab, this inserts the item into the expression in the **Expression** area. You can also create or edit expressions directly by entering text in the **Expression** area.

When you enter an expression, note that Variables are valid assignment targets and Constants are not valid assignment targets. Thus, you should use both tabs if you are unsure what type of item you want to add to the expression you are building.

Specify an argument for a selected function by placing the cursor inside the function in the **Expression** field and double-clicking the expression or function to insert. For example, place the cursor inside the parentheses of a function and select a variable. This inserts the variable in the expression at the cursor position.

### 4.10.3 What You Need to Know About Working with Expressions

XML fact types allow XML Schema types, elements, and attributes to be used when writing rules. Elements and types defined in XML Schema can be imported into the data model and can then be used to create rules and Decision Tables, just as with Java fact types and RL Fact types. The mapping between the XML Schema definition and the XML Fact types uses the Java Architecture for XML Binding (JAXB). By default, Oracle Business Rules uses the JAXB 2.0 shipped with the Oracle Application Server. JAXB as defined in JSR-222 provides a mapping between the types, names, and conventions in an XML Schema definition and the available types, allowed names and

conventions in Java. For example, an element named `order-id` and of type `xsd:integer` is mapped to a Java Bean property named `orderId` of type `BigInteger` (and `xsd:int` type maps to Java `int`).

You can use expressions in Oracle Business Rules. Expressions allow arithmetic using the operators `*`, `+`, `/`, `%`, and other supported operators on primitive numerics, for example `double`, `int`, and the numeric types `Integer`, `Long`, `Short`, `Float`, `Double`, `BigDecimal`, and `BigInteger` that are available in the built-in dictionary. For more information on supported primitive numerics, see *Rules Language Reference for Oracle Business Process Management*.

Expressions allow casting between any two numeric types, for example, `(short)((BigInteger)1 + (Long)2)`. [Example 4-3](#) shows a few additional sample expressions.

The expression processor uses the XPath/Xquery rules for type promotion (XML Path Language (XPath) 2.0). For example, `BigDecimal` is promoted to `float/double`; type promotion going the other direction requires a cast, except for literals such as `3.3`.

**Example 4-3 Sample Expressions in Actions with Types and Casting**

```
assign new double db = 3.3
assign new BigDecimal bd = 3.3 // no cast required
assign db = bd // no cast required
assign bd = (BigDecimal)db // cast is required
```

## 4.11 Using Bucketsets as Constraints for Options Values in Rules

You can use List of Values Bucketsets and List of Ranges Bucketsets to specify constraints for business terms in rules. This allows you to use Rules Designer to produce validation warnings for possible errors where a value supplied is out of range, or not within a set of possible values as specified in a bucketset. Oracle Business Rules also lets you use bucketsets to specify constraints for global initial values, function return values, or function argument values. For more information, see [Section 2.3, "Working with Oracle Business Rules Globals"](#) and [Section 3.7, "Associating a Bucketset with Business Terms"](#).

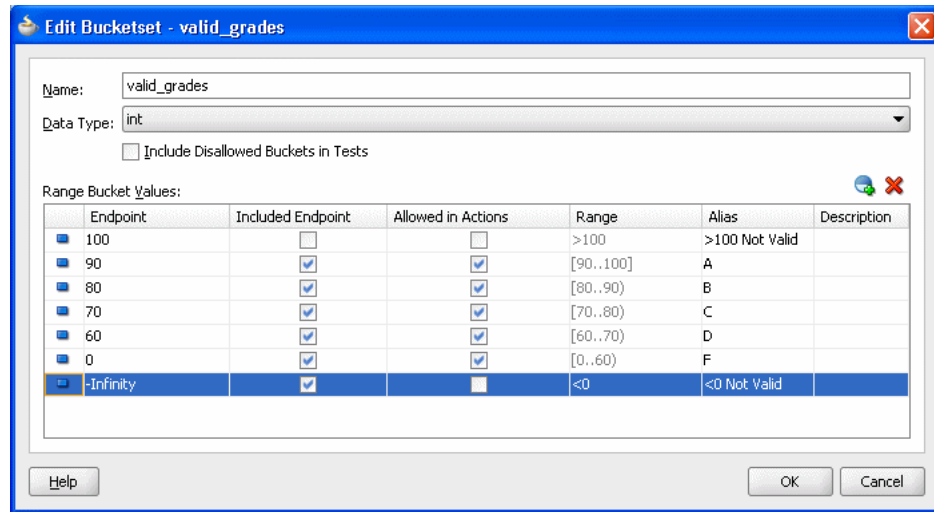
### 4.11.1 How to Use a List of Ranges Bucketset as a Constraint for a Business Term

You can use a list of ranges bucketset as a constraint for any business term other than a function result.

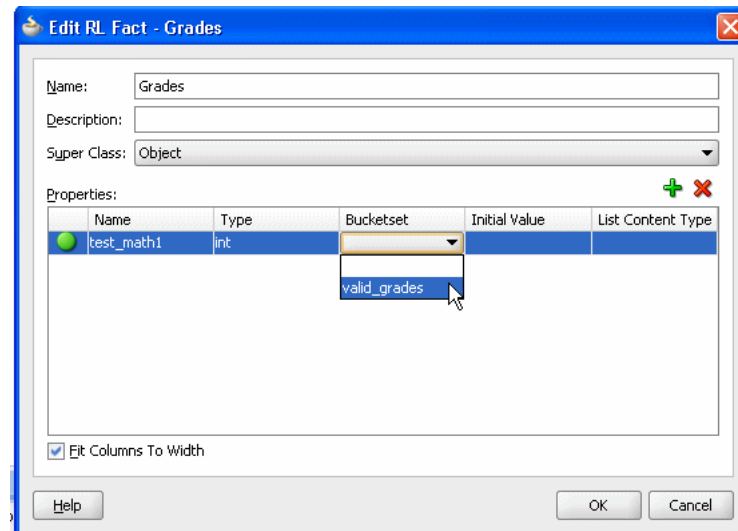
For more information on using a list of values bucket set as a constraint, see [Section 4.11.2, "How to Use a List of Values Bucketset as a Constraint for a Fact Property"](#).

**To use a List of Ranges bucketset as a constraint for a fact property:**

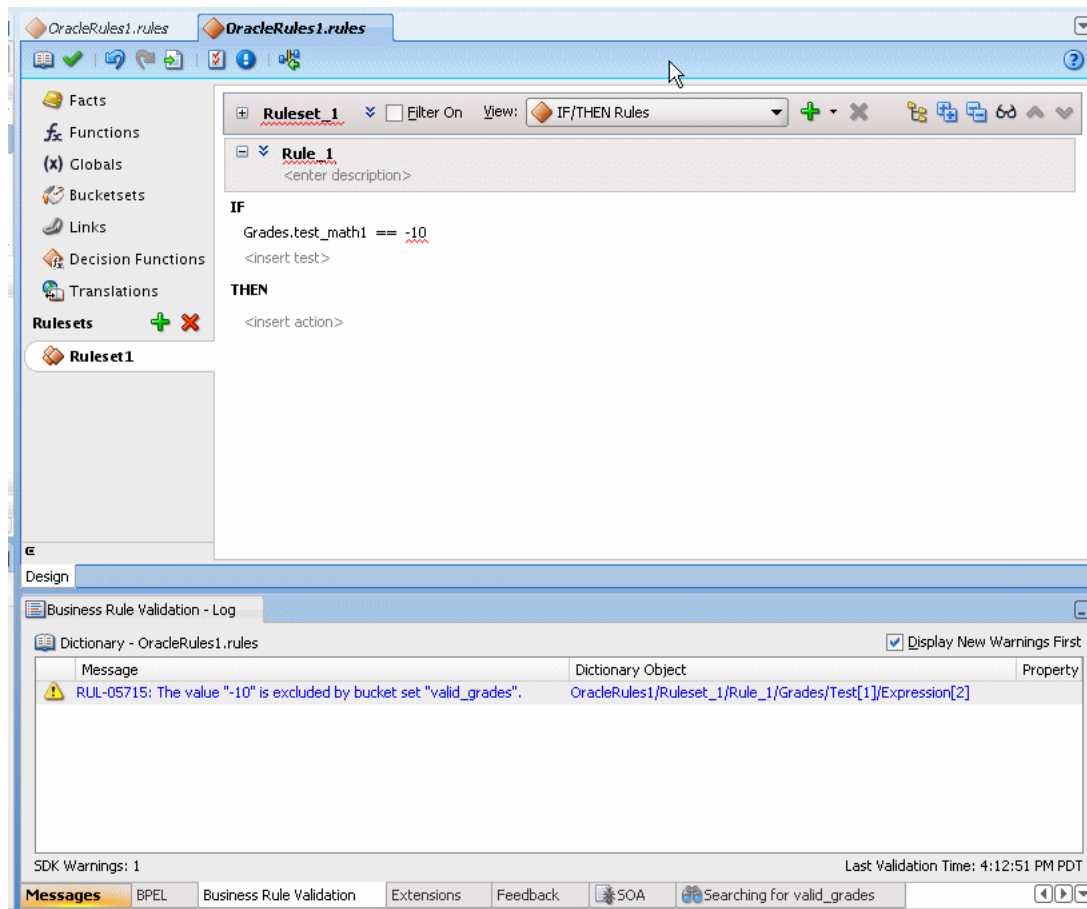
1. Specify a bucketset that includes the ranges you want to include and select **Allowed in Actions** for all valid ranges. To include a range, deselect **Allowed in Actions** for the top and bottom endpoints.
2. Select **Included Endpoint** as needed for the application.
3. Deselect **Include Disallowed Buckets in Tests**. For example, for a bucketset that defines valid grades and that does not allow values greater than 100, or less than 0, define the bucketset endpoints as shown in [Figure 4-74](#).

**Figure 4–74 Valid Grades Bucketset for Fact Property**

- Associate this bucketset with a business term. For example, associate the bucketset with test\_math1 as shown in Figure 4–75.

**Figure 4–75 Associating a Bucketset with a Fact Property**

Now, if you define a rule with a test that uses the fact property you receive a validation warning when a value is out of range. For example if you define a rule with an expression with the value -10, Rules Designer shows a validation warning as shown in Figure 4–76.

**Figure 4–76 Using a Fact Property Value that is not in the Allowed in Actions for Associated Bucketset**

### 4.11.2 How to Use a List of Values Bucketset as a Constraint for a Fact Property

You can use a list of values bucketset as a constraint for a fact property.

For more information on using a list of ranges bucket set as a constraint, see [Section 4.11.1, "How to Use a List of Ranges Bucketset as a Constraint for a Business Term"](#).

#### To use a List of Values bucketset as a constraint for a fact property:

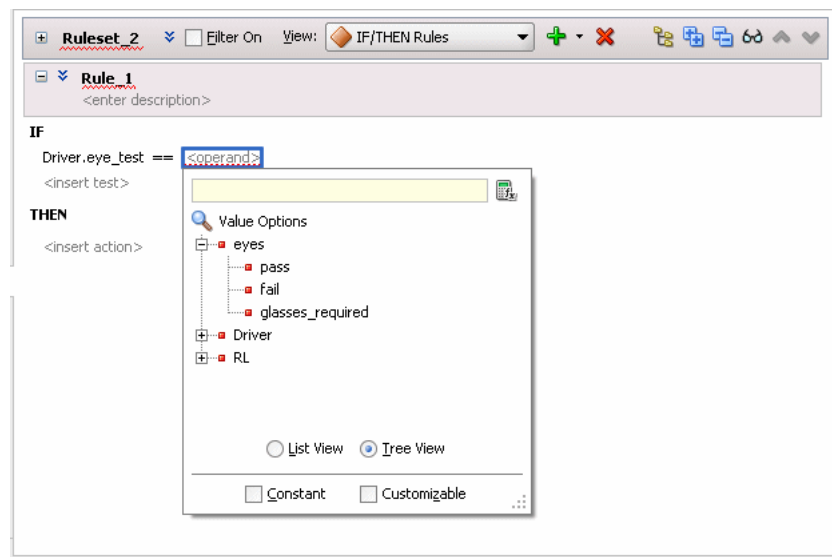
1. Specify an LOV bucketset that includes the values you want to include, and select **Allowed in Actions** for all valid values. For more information, see [Section 3.6.1, "How to Define a List of Values Global Bucketset"](#).
2. Deselect **Allowed in Actions** for the otherwise bucket.
3. Deselect **Include Disallowed Buckets in Tests**.
4. Associate this bucketset with a fact property.

### 4.11.3 How to Use Bucketsets to Provide Options for Test Expressions

You can use LOV bucketsets to provide options for expressions and actions.

**How to use bucketsets to provide options for rule expressions and actions:**

1. In Rules Designer, define an LOV bucketset of a type corresponding to a fact property. For more information, see [Section 3.6.1, "How to Define a List of Values Global Bucketset"](#).
2. Associate the bucketset with a fact property. For more information, see [Section 3.7.1, "How to Associate a Bucketset with a Fact Property"](#).
3. When you enter expressions, Rules Designer shows the bucket values in the values options. For example, when you associate a fact property `Driver.eye_test` with an LOV bucketset named `eyes`, with values: `pass`, `fail`, and `glasses_required`, and then you use `Driver.eye_test` in a test expression, the bucket values are limited as shown in [Figure 4-77](#).

**Figure 4-77 Using a Bucketset to Provide Options for a Rule Test Expression**

## 4.12 Importing Runtime Rules Changes From Repository Into JDeveloper

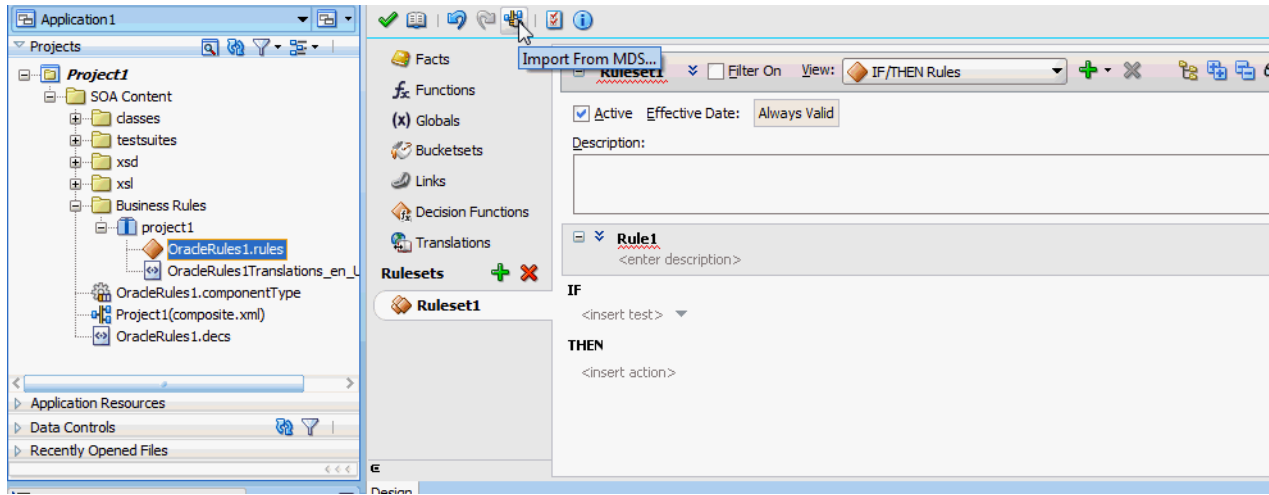
This section discusses how to import changes to a rule implemented in SOA Composer into the JDeveloper.

When you make changes to a dictionary in SOA Composer, you must upload them to MDS repository as described in [Section 12.10, "Committing Changes for an Oracle Business Rules Dictionary at Runtime"](#). However, these changes do not get updated in JDeveloper. You need to import the changes from MDS repository into JDeveloper manually.

To import the changes into the JDeveloper,

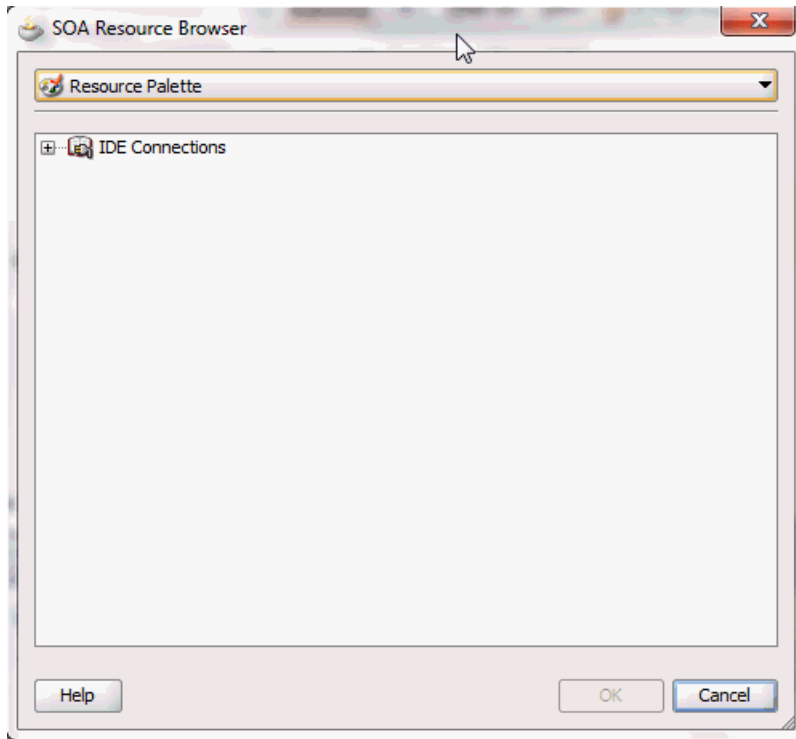
1. Select the rule in the application navigator for which changes were made.
2. Click the **Import From MDS** button in Rule Editor as shown in [Figure 4-78](#).

**Figure 4–78 Importing Changes from MDS Repository**



3. Select the MDS Repository in the SOA Resource Browser window that opens.

**Figure 4–79 Select the MDS Repository in SOA Resource Browser**



4. Click **OK**.  
Changes are updated in JDeveloper and you can view the changes in the Rule Editor.

---

---

## Working with Decision Tables

This chapter describes how to use Decision Tables to create and use business rules in an easy to understand format that provides an alternative to the IF/THEN rule format. It also covers the various components of a Decision Table such, as conditions, conflicts, actions, and discusses the various operations that you can perform on a Decision Table.

The chapter includes the following sections:

- [Section 5.1, "Introduction to Working with Decision Tables"](#)
- [Section 5.2, "Creating Decision Tables"](#)
- [Section 5.3, "Performing Operations on Decision Tables"](#)
- [Section 5.4, "Creating and Running an Oracle Business Rules Decision Table Application"](#)

### 5.1 Introduction to Working with Decision Tables

Businesses invest in software to automate their business processes. Historically, this automation focused on the collection, presentation, and manipulation of data to facilitate human decision-making about that data. Increasingly, however, software designers and developers are called upon to automate the decision making process by putting detailed rules about business processes into software architectures. In addition, many enterprises are experiencing increasing pressure to make software systems more responsive to business changes. In some cases, the role of writing and testing business rules is no longer assigned to software engineers, but is passed to trained business users. Alternatively, some organizations attempt to separate changes in the business behavior of software from the traditional software development cycles, and tie changes to business driven imperatives like product or sales cycles.

A Decision Table provides a mechanism for describing data processing tasks, especially when that description is done by business analysts rather than computer programmers.

The Decision Table format is intuitive for business analysts who are familiar with spreadsheets. The formal structure that a Decision Table provides makes it easier to author, understand, and change multiple similar rules and lets software check for rule completeness and consistency.

Oracle Business Rules Decision Tables provide the following features:

- **Powerful Visualization:** Compact and structured presentation. This visualization matches the way real world business policies are expressed: with many tables, declarative, and organized into simple steps.

- **Error Prevention:** Avoids incompleteness and inconsistency. Because a Decision Table is well structured, automated tools can check for conflicts, redundancy, and incompleteness to speed development of valid, consistent business rules.
- **Modular Knowledge Organization:** Group rules into a single table. A spreadsheet metaphor puts groups of rules that work together onto a single viewable pane. For example, if there are six rules that check an applicant's eligibility, it is more convenient to see all the rules than to view the rules as individual but related rules.
- **Optimization of Rules and Performance Benefits:** Oracle Business Rules Decision Tables provide automated features that can reduce the number of required rules, as compared to the IF/THEN rules (this is called rule coalescing).
- **Rule Validation and Verification:** Provides capabilities for ensuring the logical consistency of rules before deployment. Automated tools for checking conflicts, incompleteness, or gaps, help speed development of valid, consistent business rules.

Ease of verification and visualization are the major reasons for using Decision Tables.

For information, see [Chapter 4, "Working with Rulesets and Rules"](#).

### 5.1.1 What is a Decision Table?

A Decision Table displays multiple related rules in a single spreadsheet-style view. In Rules Designer a Decision Table presents a collection of related business rules with condition rows, rules, and actions presented in a tabular form that is easy to understand. Business users can compare cells and their values at a glance and can use Decision Table rule analysis features by clicking icons and selecting values in Rules Designer to help identify and correct conflicting or missing cases.

To help understand Decision Table concepts, consider a set of IF/THEN rules that determine if a driver is eligible for a license, and an equivalent Decision Table. Note if a driver has taken a driver training class then the driver has training certification.

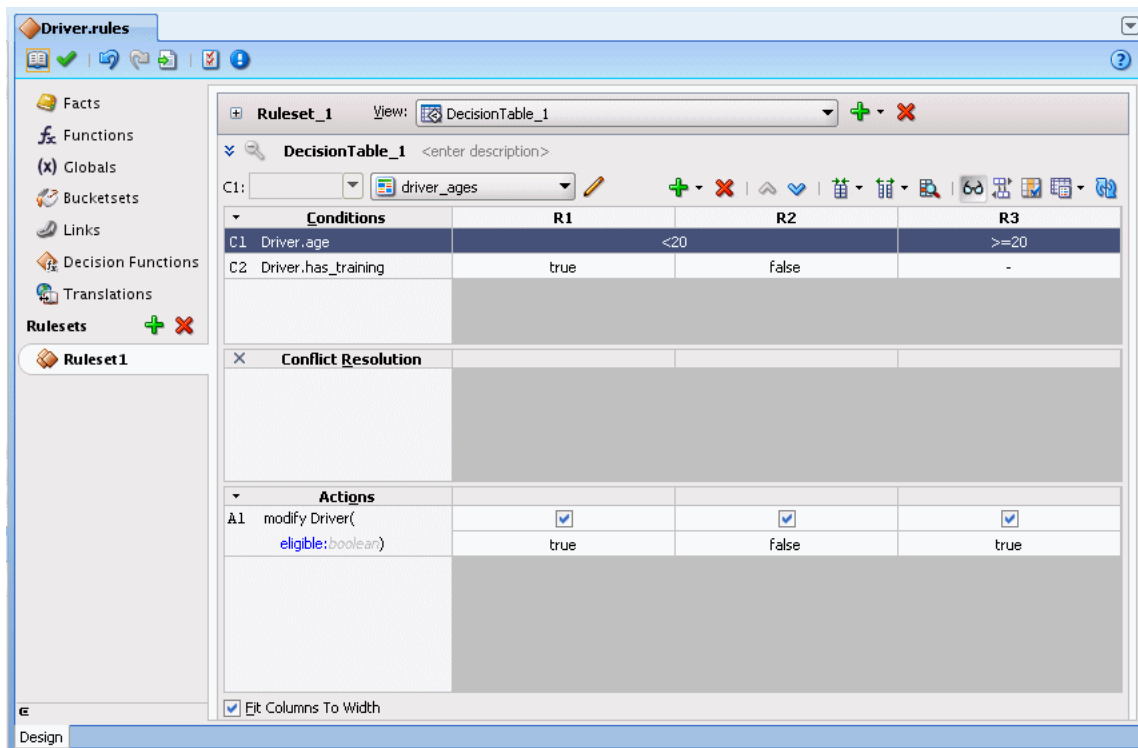
The IF/THEN rules follow:

```
if driver.age < 20 and driver.has training then driver.eligible = true
if driver.age < 20 and driver.has training = false then driver.eligible = false
if driver.age >= 20 then driver.eligible = true (do not care about training for this case)
```

[Figure 5–1](#) shows a Decision Table representation of these rules that includes areas for Decision Table **Conditions** and **Actions**.



Figure 5–1 Sample Decision Table with Conditions and Actions



### 5.1.1.1 What You Need to Know About Decision Table Conditions

The **Conditions** area in a Decision Table includes one or more condition rows. Each condition row has a condition expression and, for each rule, a condition cell. A **condition expression** is an expression that you build in Rules Designer. The condition expression is often a fact property or a function result, but it can be any expression that has a type that can be associated with a bucketset. Test expressions are often used, such as `Driver.age<16`. These expressions are associated with the built-in boolean bucketset, with values `true` and `false`. The value or the range for a given **condition cell** takes its value or its range from one or more buckets in the associated LOV or Ranges bucketset. For more information on bucketsets, see [Section 3.6, "Working with Bucketsets"](#).

For example, [Figure 5–1](#) shows the condition expression for a `Driver` fact with the `Driver.age` property. The corresponding row in the Decision Table shows condition cells including buckets for the ranges `<20`, and `>=20`. The values in the cells come from the global bucketset named `driver_ages`.

[Figure 5–1](#) also shows a condition row for the `Driver` fact with the `Driver.has_training` property. This condition row shows condition cells with the values, `true`, `false`, and `-`. The hyphen (`-`) means "do not care" (that is `Driver.has_training` could be `true` or `false` in this case). The values for these condition cells come from the default bucketset associated with boolean types (this consists of default buckets for the values `true` and `false`).

Decision Tables show rules in bucket order, and to change the order of rules you need to change the order of buckets in the bucketsets. Thus, the order of the buckets in the bucketset associated with a condition row determines the order of the condition cells, and thus the order of the rules. You can control rule ordering in a Decision Table by changing the relative position of the buckets in an LOV bucketset associated with a condition row; however, you cannot reorder range buckets. For information on

ordering buckets in a bucketset, see [Section 3.6.1, "How to Define a List of Values Global Bucketset"](#).

### 5.1.1.2 What You Need to Know About Decision Table Actions

Actions are associated with rules in a Decision Table. At runtime, when facts match for condition cells, the Rules Engine prepares to run the actions associated with the rule.

[Table 5–1](#) shows the types of actions you can choose in the **Actions** area. Thus, in an action you can call a function, assert a new fact, retract a fact, or modify a fact. In the **Actions** area the cells corresponding to an individual action for a rule are called **action cells**. Note, in advanced mode there are additional options for actions. For more information on advanced mode, see [Section 4.5.2, "How to Select the Advanced Mode Option"](#).

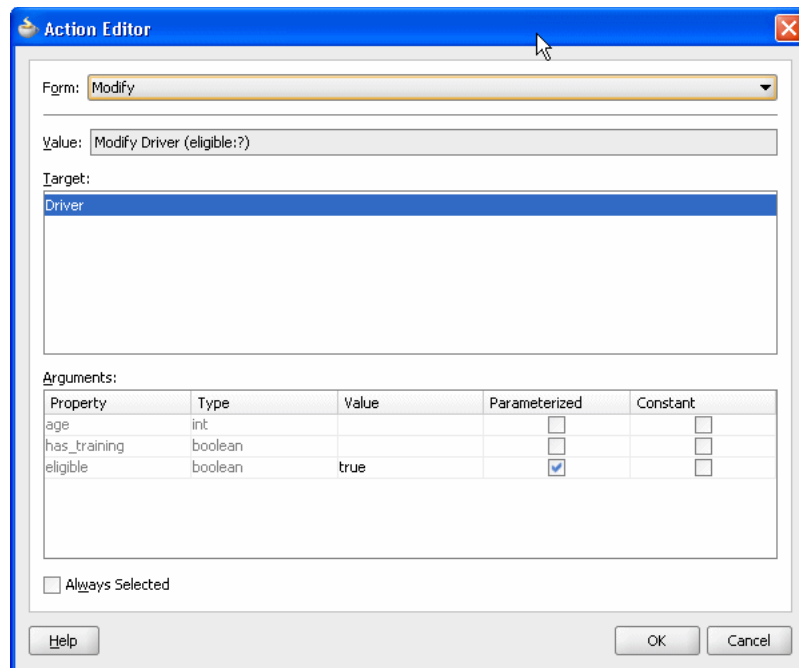
**Table 5–1 Decision Table Actions for Action Cells**

Action	Description
assert new	Assert a new fact
call	Call a function
retract	Retract a fact
modify	Modify a data value associated with a matched fact

When you add multiple actions the actions that you add in the **Actions** area are ordered; actions appearing in the higher rows run before actions in the following rows.

The Decision Table actions such as `modify` can refer to facts matched in the condition cells. For example, given a Decision Table with condition rows on the `Driver` fact that includes condition rows for `Driver.age` and `Driver.has_training`, actions can modify the property `Driver.eligible` and you can specify a value for `Driver.eligible` for each action cell.

Certain types of actions in the **Actions** area include a **Parameterized** checkbox. This checkbox specifies that a property from the action can have its value set in the action cell associated with a rule in the Decision Table. When the parameterized checkbox is selected the value you supply for the expression value in the action, in the **Actions** area, becomes the default value for the property if a value is not supplied in the action cell. For example, see [Figure 5–2](#) where the value `false` is assigned as the default value for the action property `eligible`.

**Figure 5–2 Action Editor Showing Parameterized Action with Default Value**

### 5.1.1.3 What You Need to Know About Decision Table Rules

A ruleset contains a Decision Table; this provides a way to group the Decision Table along with IF/THEN rules. When rules and Decision Tables are grouped in a ruleset, the IF/THEN rules and the Decision Table rules all execute as a set of interrelated rules.

A rule in a Decision Table is not named. Although Rules Designer shows rules in a Decision Table with labels, for example, R1, R2, and R3, these rule labels are not names for individual rules but are labels derived from the current ordering of the rules in the Decision Table. Thus, a rule with the label R1 could be moved to position 3 and then Rules Designer relabels this rule R3.

Rules in a Decision Table are organized as a table that contains a tree of condition cells. The condition cells in the first row span the cells of later condition rows. A parent cell in row  $i$  spans its children in row  $i+1$ .

Figure 5–3 shows rules in a Decision Table where each rule consists of one cell from each row in the **Conditions** area, and an associated action cell in the same column in the **Actions** area. Figure 5–3 shows the rule with the label R3 defined by the first cell from condition 1 (the `Driver.age < 20` bucket), the second cell from condition 2 (the `Driver.eye_test` equals fail bucket), and the third cell from condition 3 (the `Driver.has_training` equals true bucket). Likewise for each of the other rules, R1 to R12, there is a unique path through the Decision Table.

**Figure 5–3 Rules in a Decision Table**

As shown in Figure 5–3, it is significant for a cell to be a parent of another cell and a parent cell spans lower cells. In the **Conditions** area, when condition cells have the same parent condition cell the cells are called **siblings**. Certain operations only apply for condition cells that are siblings. For example, Figure 5–4 shows two sibling cells that are selected; with these cells selected the **Merge Selected Cells** operation is valid. For these cells, the corresponding bucket with the value fail for Driver.eye\_test is also a sibling (as shown in the R3 and R4 columns in Figure 5–4). For more information, see Section 5.3.3, "How to Merge or Split Conditions in a Decision Table".

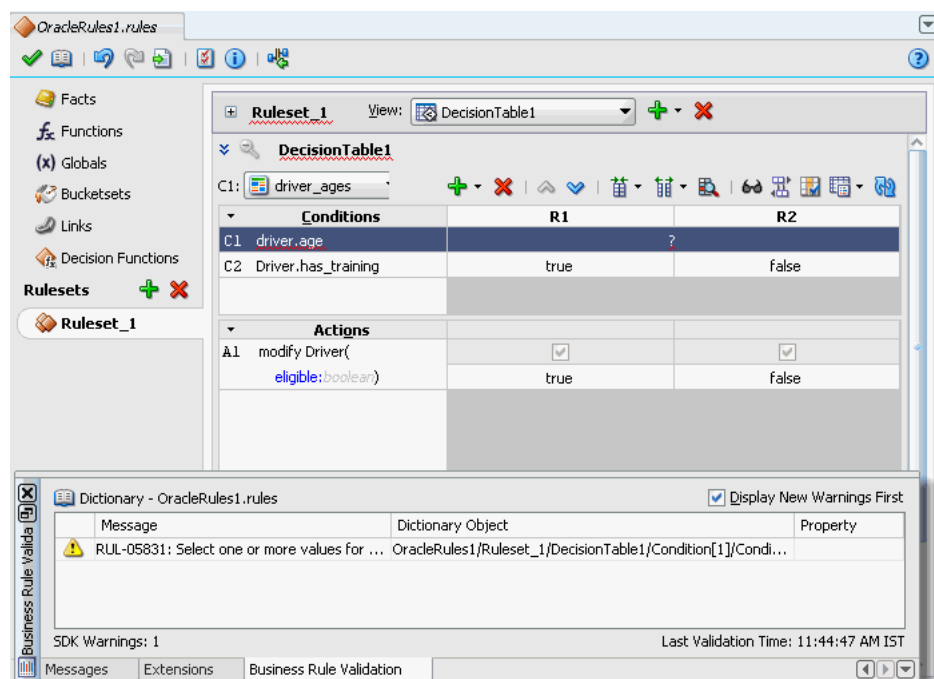
**Figure 5–4 Sibling Condition Cells in a Decision Table**

Rules Designer lets you easily reorder rows by selecting the row and clicking a **Move** icon. By reordering rows in the **Conditions** area you can perform operations on condition cells at the desired granularity. Thus, the move operations can assist you when you want to split, merge, or assign certain values that might only be appropriate at a particular level in the tree, depending on the location of a condition cell or depending on the location of the parent, children, or siblings of a condition cell.

## 5.1.2 Understanding Decision Table Values

By default, when you create a condition row, Rules Designer creates a single condition cell and assigns the "?" value to the cell. A condition cell with the value "?" indicates that the value of the cell is undefined in the bucketset. For example, [Figure 5-5](#) shows a "?" value for `Driver.age`.

**Figure 5-5** Sample Decision Table Showing Undefined in Condition Cell



In the Decision Table **Actions** area you can specify that an action cell "do nothing". In this case, deselect the action cell. When the action cell checkbox is unselected this means do not perform this action when the pattern matches for the specified condition values in the Decision Table. Thus, for each action cell you can specify whether the rule associated with the action cell should activate the action, or does not perform the action.

In a Decision Table, when a condition cell represents a bucket that has been removed from the bucketset, Rules Designer provides a validation warning such as the following:

RUL-05831: Decision table bucket reference not found

To fix this type of validation warning you can do one of the following:

- Define a value by double-clicking the condition cell and selecting one or more buckets from the list.

- Add the missing bucket to the bucketset or associate the condition with another bucketset that contains the missing bucket.

### 5.1.3 What You Need to Know About Decision Table Loops

A Decision Table loop occurs when the value for a condition row is changed by an action. Loops can occur across the rules in a single Decision Table or spread over several Decision Tables, or spread over rules and Decision Tables in the same ruleset. Try not to create Decision Table actions that modify fact properties that are used in Decision Table conditions. This could cause an infinite loop.

---



---

**Note:** You can prevent infinite loops by using the rule firing limit on the containing decision function.

---



---

## 5.2 Creating Decision Tables

You add a Decision Table by performing several steps. These steps include:

- Create a Decision Table
- Add conditions to the Decision Table
- Add actions to the Decision Table
- Use Decision Table operations to validate, correct, and modify the Decision Table

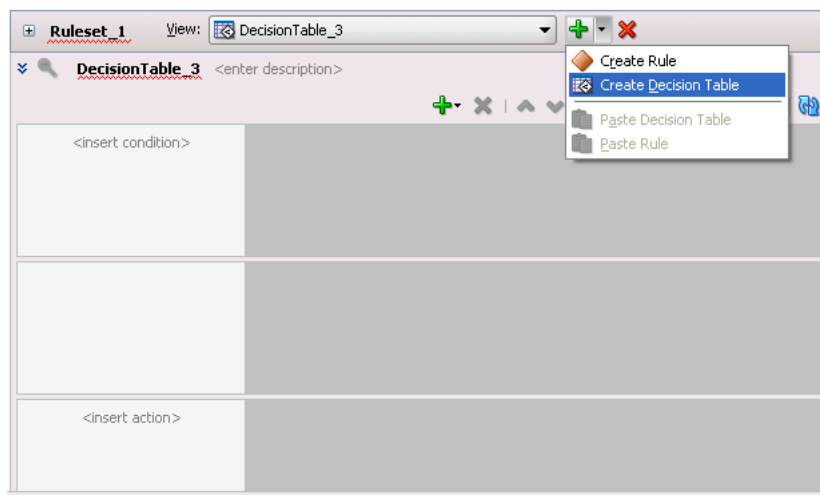
### 5.2.1 How to Create a Decision Table

To work with a Decision Table you start by creating a Decision Table in a ruleset.

**To create a decision table:**

1. From Rules Designer select an existing ruleset from the rulesets tab or create a ruleset by clicking **Create Ruleset...**
2. Click the **Add** icon and from the list select **Create Decision Table**, as shown in [Figure 5–6](#). This creates a Decision Table.

**Figure 5–6 Adding a Decision Table**



---

**Note:** When you add a Decision Table the rules validation log displays validation warnings. The Decision Table is not complete and does not validate without warnings until you add conditions and actions to the Decision Table.

---

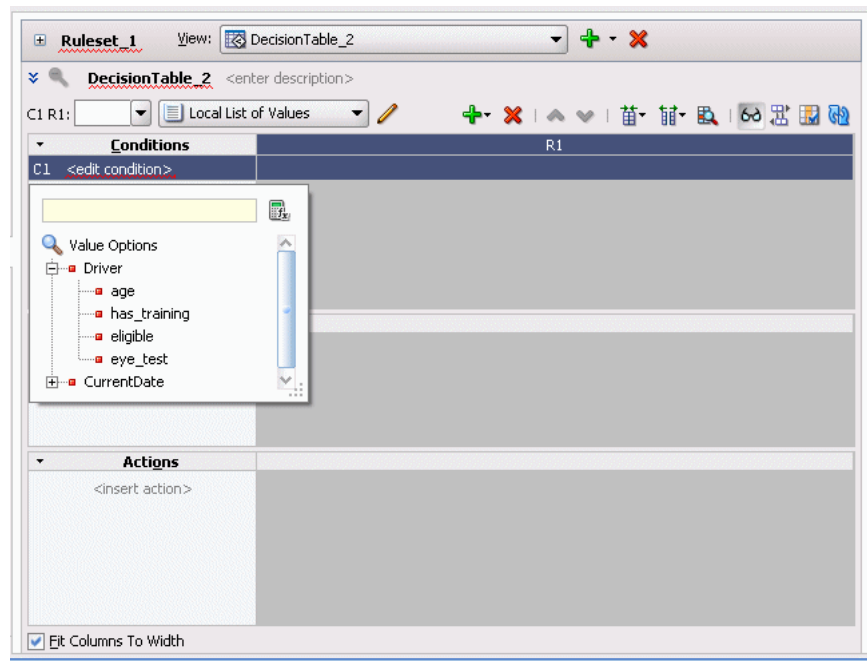
## 5.2.2 How to Add Condition Rows to a Decision Table

A Decision Table includes a **Conditions** area where you specify Decision Table condition rows. The condition rows determine the facts that the Oracle Rules Engine matches at runtime. To create a Decision Table you need to add one or more condition rows to the Decision Table.

### To add condition rows to a decision table:

1. From Rules Designer select a ruleset from the **Rulesets** navigation tab and select the Decision Table where you want to add conditions.
2. In the Decision Table area, from the list next to the **Add** icon select **Condition**.
3. In the **Conditions** area, double-click **<edit-condition>** to display the navigator to select or enter an expression as shown in [Figure 5-7](#).

**Figure 5-7** Adding a Condition to a Decision Table

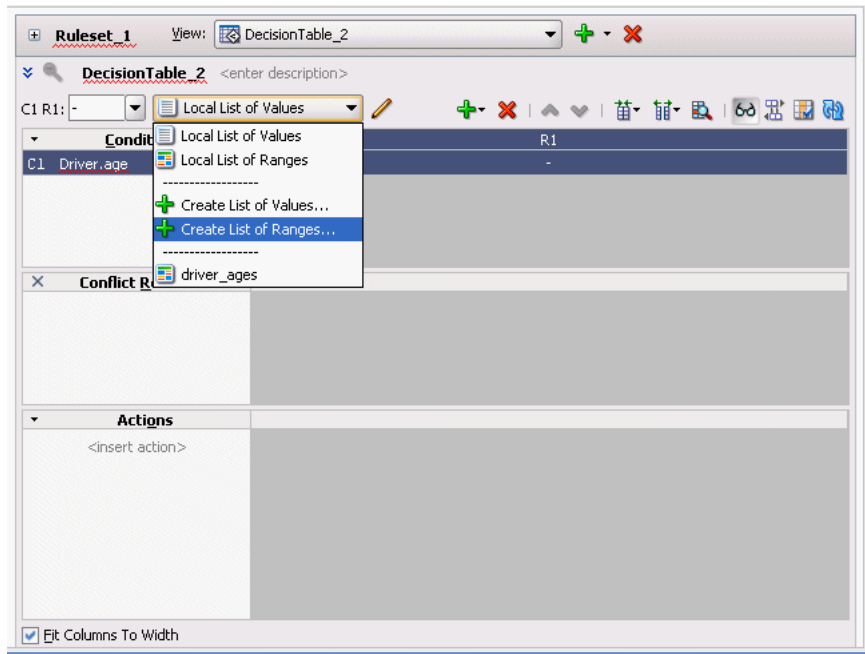


4. Enter an expression by clicking in the navigator to select a variable or click the **Expression Builder** icon to display the **Expression Builder** window. The **Expression Builder** lets you build expressions.
5. Each condition row requires a bucketset from which to draw the values for each cell. When the value you select has an associated global bucketset, then by default the bucketset is associated with the condition row.
6. Repeat **Step 2** through **Step 5**, as required to add additional condition rows in the Decision Table.

**To use a local bucketset or specify the bucketset for a decision table condition:**

1. Each condition row requires a bucketset from which to draw the values for each cell. When the value you select has an associated global bucketset, then by default the bucketset is associated with the condition row.
2. If there is no global bucketset associated with the value, then after you add a condition row to a Decision Table you need to specify either a Local List of Values or a Local List of Ranges bucketset to associate with the condition row, or specify an existing global bucketset. To add a bucketset for the condition, in the **Conditions** area select the condition and then select from the Bucketset list to associate a bucketset, as shown in [Figure 5–8](#). The bucketset list includes available global bucketsets of the appropriate type.

**Figure 5–8 Specifying a Bucketset For a Condition Row in a Decision Table**



3. If you do not specify a global bucketset, then you can create and use a local bucketset by selecting either **Local List of Values** or **Local List of Ranges** to create and use the specified type of bucketset.
4. Repeat **Step 2** through **Step 3**, as required to define additional condition rows in the Decision Table.

For more information on creating bucketsets, see [Section 3.6, "Working with Bucketsets"](#).

### 5.2.3 How to Add Actions to a Decision Table

A Decision Table includes an **Actions** area where you specify Decision Table actions. The actions determine actions for rules in a Decision Table.

To create a valid Decision Table you need to do the following:

1. Add actions to a Decision Table.
2. For each action cell, where specific values apply, set the values for the action cells.

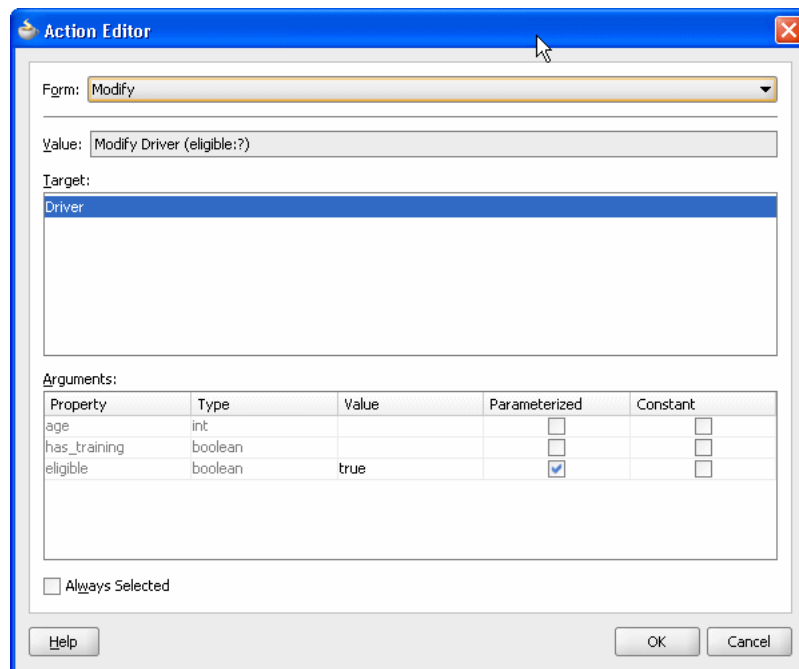


- For each action cell, when the action does not apply to the rule, deselect the action cell. By default when you add an action to a Decision Table, actions for all the rules are unselected.

**To add actions to a decision table:**

- From Rules Designer select a ruleset from the **Rulesets** navigation tab and select the Decision Table where you want to add actions.
- From the list next to the **Add** icon select **Action** and select an available action from the list. Table 5-1 lists the available actions. For example, select **Modify**. Rules Designer displays the Action Editor dialog as shown in Figure 5-9.

**Figure 5-9 Adding an Action to a Decision Table**



- In the Action Editor dialog select the action target in the **Target** area. This specifies the data model object the action applies to.
- For the specified target, as needed to make the action do what is required, modify the fields in the **Arguments** table. In the Action Editor dialog the **Arguments** table includes the fields shown in Table 5-2.

**Table 5-2 Action Editor Dialog Arguments Fields**

Field	Description
Property	Displays the property names for the specified target.
Type	Displays the type for the property.
Value	Select the default value for the action from the list of available actions. The specified value applies to either the entire action, as the default value, or when a particular action cell is selected, the value specified applies for that particular action cell.
Parameterized	This specifies a parameterized value. A parameterized value displays in a Decision Table action cell. When you select parameterized value for a property, this generally means that each rule supplies a different parameter value.

**Table 5–2 (Cont.) Action Editor Dialog Arguments Fields**

Field	Description
Constant	Select to specify a constant value.

- In the Action Editor dialog, to select action cells for all the rules, select the **Always Selected** checkbox.
- Repeat **Step 2** through **Step 5**, as required to define additional actions for the Decision Table.

**To set values for action cells in a decision table:**

- From Rules Designer, select a ruleset from the **Rulesets** navigation tab and select the Decision Table where you want to specify action cell values.
- In the **Actions** area, check that the appropriate action cells are selected. If the **Always Selected** checkbox is specified in the Action Editor dialog, then all action cells should be selected. If **Always Selected** is not selected, then select the appropriate action cells using the action cell checkbox.
- In the **Actions** area, enter the appropriate value for parameterized properties for each selected action cell. To do this select the action cell property cell, and either enter a value, select a value from the list, or click the **Expression Builder** icon to use the Expression Builder dialog.

For more information on referring to a bucketset from a Decision Table, see [Section 3.6.2, "How to Define a List of Ranges Global Bucketset."](#)

**To deselect an action cell in a decision table:**

- From Rules Designer select a ruleset from the **Rulesets** navigation tab and select the Decision Table where you want to deselect an action cell.
- In the **Actions** area, select the action cell and deselect the checkbox in the action cell. You are not allowed to deselect action cell values when **Always Selected** is selected for the action.

When you add actions, you may need to change the order of the actions. In Rules Designer you can use the **Move Down** icon or **Move Up** icon to change the order of actions.

## 5.2.4 How to Add a Rule to a Decision Table

You can add a rule to a Decision Table. Rules Designer adds a column for the rule to the left of the existing rules and each condition cell is initialized to "?", which actually means a validation error prompting you to populate the cell with relevant values.

**To add a rule to a decision table:**

- From Rules Designer select a ruleset from the **Rulesets** navigation tab and select the Decision Table where you want to add the rule.
- From the list next to the **Add** icon, select **Rule**.
- Enter values for the condition cells. Notice that the new rule is added as the first rule of the Decision Table on the left and the other rules have moved as required to keep the bucket values in their defined order.
- Enter values for the action cells.

### Ordering Rules by Bucket

The **Order Rules By Bucket** checkbox under the Advanced Settings of a Decision Table is selected by default. In this case, the Decision Table layout changes automatically on adding new rules.

When you add a new rule to a Decision Table, the new rule is added as the first rule of the Decision Table and the other rules move as required to keep the bucket values in their defined order. This is because **Order Rules By Bucket** is enabled, which means rule ordering in a Decision Table is set according to the relative position of buckets associated with a condition expression. If **Order Rules By Bucket** is not enabled when you add a rule, the new rule is added as the last rule of the Decision Table. In either case, the cells in the new rule column have "?" symbols, indicating the cells do not have values yet.

---

**Note:** When Order Rules By Bucket is selected, the rules are ordered and duplicate rules (rules with exactly the same buckets) are combined. So, you cannot add two rules without any buckets to a Decision Table, because in that case, the rules are duplicates and would immediately be combined. When Order Rules By Bucket is deselected, then duplicate rules are allowed.

---

In addition, the **Move Left** and **Move Right** buttons pertaining to a rule column is also enabled and you can reposition rules. The **Span** options also get enabled and you can also cut, copy, or paste rules.

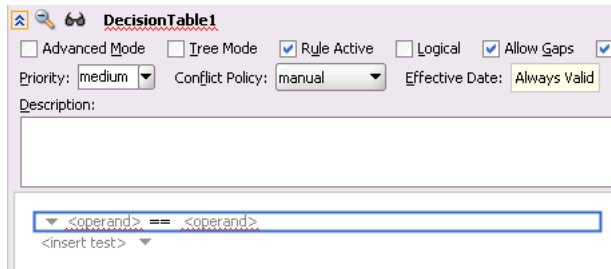
## 5.2.5 How to Define Tests in a Decision Table

You can define tests in a Decision Table. The tests must evaluate to true for any rule in the decision table to fire. For more information about defining tests and working with rule conditions, see [Section 4.3, "Working with Rules"](#).

### To add tests to a Decision Table:

1. From Rules Designer select a ruleset from the **Rulesets** navigation tab and select the Decision Table where you want to add the rule.
2. Click the **Show Advanced Settings** icon (double downward pointing arrows) next to the Decision Table name. If **Advanced Mode** is selected, deselect the checkbox.
3. Just below the Decision Table name, click the **<insert test>** downward pointing arrow.
4. Select any of the following options according to your requirement:
  - simple test
  - variable
  - nested test
  - not nested test
5. Click the left and the right **<operand>** to enter the operand values, and the operator list to select an operator.

The added test is displayed in [Figure 5-10](#).

**Figure 5–10 Adding Test to a Decision Table**

## 5.3 Performing Operations on Decision Tables

After you create a Decision Table there are operations that you may want to perform on the Decision Table, including the following:

- Compact or split cells in a Decision Table
- Merge a condition or split a condition in a Decision Table
- Finding and resolving conflicts between rules in a Decision Table
- Find and fix gaps in a Decision Table

### 5.3.1 Introduction to Decision Table Operations

After you create a Decision Table you may want to modify the contents of the Decision Table to produce a Decision Table that includes a complete set of rules for all cases, or to produce a Decision Table that provides the least number of rules for the cases.

#### 5.3.1.1 Understanding Decision Table Split and Compact Operations

The split and compact operations allow you to manipulate the contents of the condition cells in a Decision Table.

The split table operation creates a rule for every combination of buckets across the conditions. For example, in a Decision Table with 3 boolean conditions,  $2 \times 2 \times 2 = 8$  rules are created. In a Decision Table with 32 boolean conditions,  $2^{32} \sim 2$  billion rules are created. Thus, you only use split table when the number of rules created is small enough that filling in the action cells is feasible.

When you want to apply match conditions for the "do not care" values in a Decision Table and create a match case for each cell, you use the split table operation.

Split can be applied to an entire Decision Table or to a single condition row. Additionally, split may be performed on an individual condition cell.

Depending on what is selected in the Decision Table, the split operation can create condition cells. Thus, using the split operation you can create rules in a Decision Table. [Table 5–3](#) summarizes the split operation for a selected condition cell, condition row, or for a complete Decision Table.

**Table 5–3 Summary of Split Operation**

Operator	Description
Condition Cell	Creates one sibling condition cell for each bucket value represented by the cell. If the condition cell value is "do not care", then the cell is split into one sibling cell for each bucket in the bucketset that is not represented by a sibling condition cell, and "do not care" is no longer represented.
Condition Row	For each condition cell in the proceeding condition expression, create a sibling group which contains a cell for each value in the bucketset. The effect of this operation is the same as adding a "do not care" to each sibling group and calling split on each condition cell in each sibling group.
Decision Table	Same as calling split on each condition row in the Decision Table.

Depending on what is selected in the Decision Table, the compact table or merge cells operations remove condition cells. The compact table operation can be applied to an entire Decision Table. Additionally, the merge operation may be performed on sibling cells or on an entire condition row. Thus, using compact table or merge you can remove rules from a Decision Table. [Table 5–4](#) summarizes the compact table and merge operations.

**Table 5–4 Summary of Merge Operation**

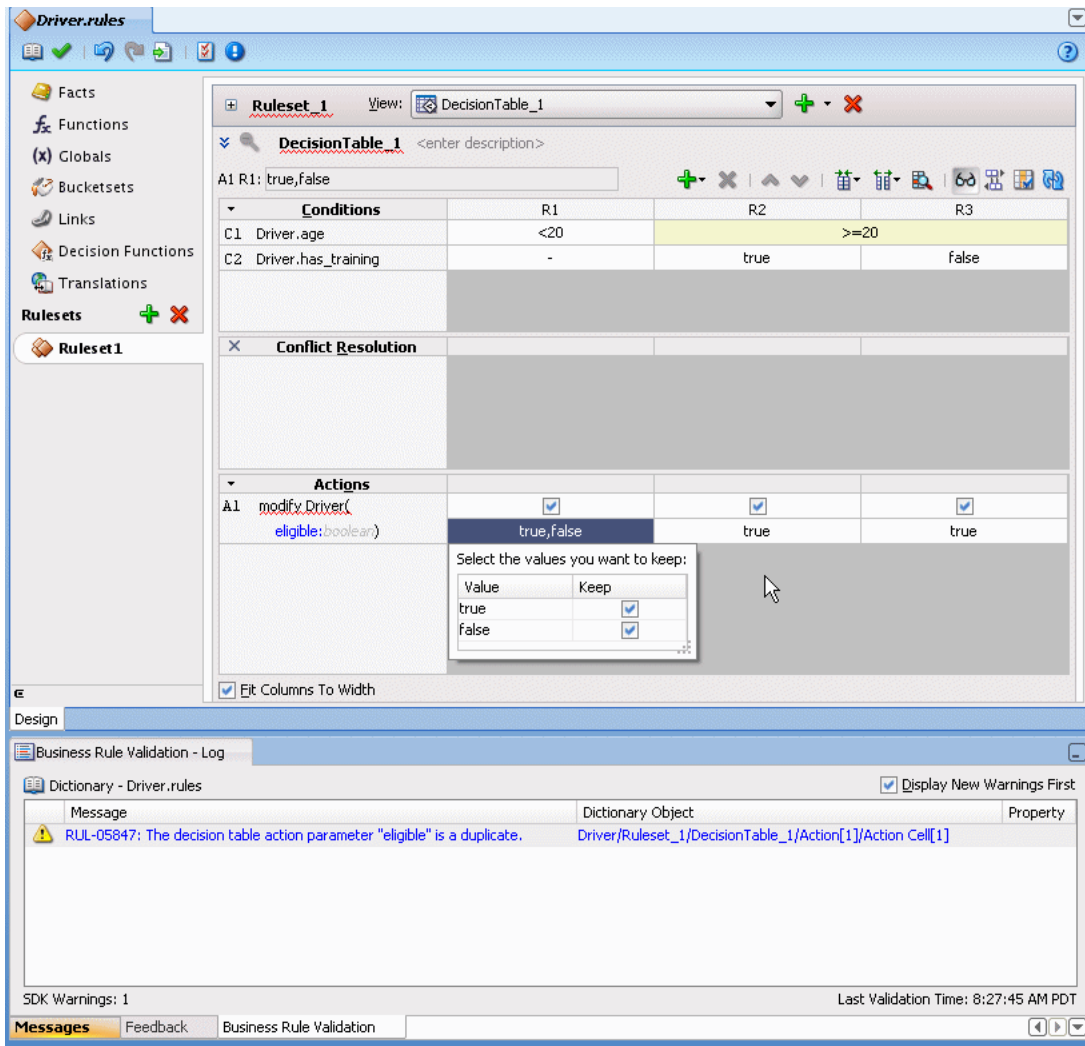
Operator	Description
Condition Cell	Merging two or more condition cells adds all buckets in the cells to a single cell, and removes all but one of the cells. If one of the cells represents "do not care", then the merged cell represents "do not care".  This operation may merge action cells and this can create warnings for duplicate action cells, such as, RUL-05847: Duplicate decision table action parameter.
Condition Row	Combine all values in each sibling group into a single "do not care" cell for each condition cell in the proceeding condition expression. The effect of this is the same as calling merge on all cells in each sibling group.  This operation may merge action cells and this can create warnings for duplicate action cells, such as, RUL-05847: Duplicate decision table action parameter.
Decision Table	Compacts the Decision Table by merging conditions of rules with identical actions.

Split and merge are inverse operations when conflicting action cells are not associated with the operation. In this case, without conflicting action cells, a merge operation combines all the values from the siblings into one sibling, and discards the other sibling condition cells, and as a result of merging the condition cells, when a Decision Table contains action cells, the action cells are also merged. Thus, the merge operation combines multiple condition cells into a single condition cell and adds all buckets to the single cell.

When there are conflicting values for the action cells, a merge operation merges the action cells in a form that requires additional manual steps. Thus, if two action cells have conflicting parameters, after the merge the action cell contains multiple conflicting parameter values. These conflicting values are appended to the action cell and must be manually resolved by selecting and deleting the unwanted duplicate parameters. For example, see [Figure 5–11](#) that shows conflicting values in an action cell.

An action cell that contains multiple values for a property is invalid. When you select the action cell Rules Designer shows a popup window with checkboxes to allow you to select a single value for the action cell. As shown in the validation log in [Figure 5–11](#), Rules Designer shows a validation warning until you select a single value.

**Figure 5–11 Conflicting Properties to be Resolved for a Merged Action Cell**



### 5.3.1.2 Understanding Decision Table Move Operations

You can move the conditions or actions in a Decision Table. The **Move** icons let you reorder condition rows in the **Conditions** area and actions in the **Actions** area. Moving conditions up or down may reorder visual display of the rules, but these operations does not change the logic in any way. For example, if (x.a == 1 and x.b == 1) is logically the same as if (x.b == 1 and x.a == 1).

When you work with Decision Tables some operations only apply for condition cells that are siblings. Using the **Move** icon you can reorder rows so that Decision Table operations apply to the tree at the desired granularity. For example, when you want to change the action of a condition cell for a single rule, then you need to move that condition cell to the last row in the Decision Table **Conditions** area. For example, consider the Decision Table shown in [Figure 5–12](#).

**Figure 5–12 Rules in a Decision Table**

The screenshot shows a decision table with the following structure:

Conditions	R1	R2	R3	R4	R5	R6	R7	R8	R9	R10	R11	R12
C1 Driver.age	<20				>=20							
C2 Driver.eye_test	pass		fail		glasses_required		pass		fail		glasses_required	
C3 Driver.has_training	true	false	true	false	true	false	true	false	true	false	true	false
<b>Conflict Resolution</b>												
<b>Actions</b>												
A1 modify Driver( eligible:boolean)	<input checked="" type="checkbox"/>	<input type="checkbox"/>	<input type="checkbox"/>	<input type="checkbox"/>	<input checked="" type="checkbox"/>	<input type="checkbox"/>	<input checked="" type="checkbox"/>	<input checked="" type="checkbox"/>	<input type="checkbox"/>	<input type="checkbox"/>	<input checked="" type="checkbox"/>	<input type="checkbox"/>

To view this table with granularity for the Driver . age, move the Driver . age condition from the first row to the third row, as shown in Figure 5–13.

**Figure 5–13 Decision Table After Move Down with Age Condition Last**

The screenshot shows the decision table after moving the Driver.age condition to the last row:

Conditions	R1	R2	R3	R4	R5	R6	R7	R8	R9	R10	R11	R12
C1 Driver.eye_test	pass				fail				glasses_required			
C2 Driver.has_training	true		false		true		false		true		false	
C3 Driver.age	<20	>=20	<20	>=20	<20	>=20	<20	>=20	<20	>=20	<20	>=20
<b>Conflict Resolution</b>												
<b>Actions</b>												
A1 modify Driver( eligible:boolean)	<input checked="" type="checkbox"/>	<input checked="" type="checkbox"/>	<input type="checkbox"/>	<input checked="" type="checkbox"/>	<input type="checkbox"/>	<input type="checkbox"/>	<input type="checkbox"/>	<input type="checkbox"/>	<input checked="" type="checkbox"/>	<input checked="" type="checkbox"/>	<input type="checkbox"/>	<input type="checkbox"/>

Now to make the Driver . age conditions "do not care" for the first two rules, where the driver passes the eyesight test and has had driver training is true, you can easily apply changes to these particular conditions when the Driver . age condition is in the last row. Thus, in this table, it is easier to view and modify age related rules when Driver . age is in the last row, with the finest granularity.



In general, the move operations can assist you when you want to split, merge, or assign certain values that might only be appropriate at a particular level in the tree, depending on the location of a condition cell, or depending on the location of the parent, children, or siblings of a condition cell.

For actions in the **Actions** area, clicking **Move Up** or **Move Down** lets you reorder the actions. Actions are ordered so that when multiple actions apply, the first action runs before subsequent actions. Thus, using the **Move Up** or **Move Down** operation on an action may be appropriate, depending on your application.

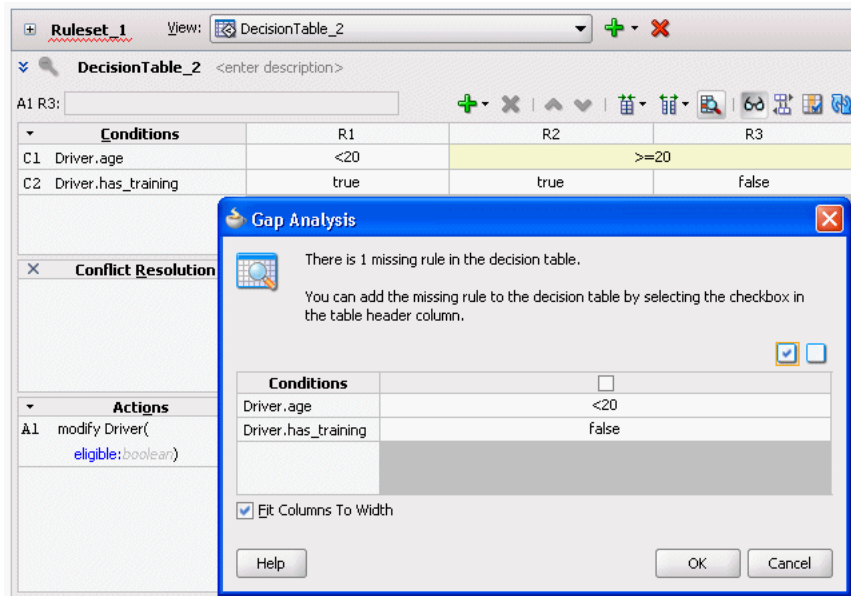
### 5.3.1.3 Understanding Decision Table Gap Checking

A gap is a "missing" rule in a Decision Table. A Decision Table has a gap if there is a combination of buckets, one from each condition, that is not covered by an existing rule. Rules Designer provides Gap Checking to check for gaps. When you click the **Gap Analysis** icon, Rules Designer finds gaps and presents a dialog to fix any gaps that are found.

You can choose to make existence of gaps a validation warning. When you deselect **Allow Gaps** in the **Advanced Settings** area, the Decision Table reports a validation warning when a gap is found. For more information, see [Section 4.5, "Using Advanced Settings with Rules and Decision Tables"](#).

For example, using the Driver example if you create a gap by deleting the rule that covers the case for `Driver.age < 20` and `Driver.has_training false`, and then you click **Gap Analysis**, Rules Designer shows the Gap Analysis dialog as shown in [Figure 5-14](#). Clicking **OK** with the checkboxes selected adds either all rules or the selected rules to the Decision Table (this example only shows a single rule to add).

**Figure 5-14** Checking Gaps



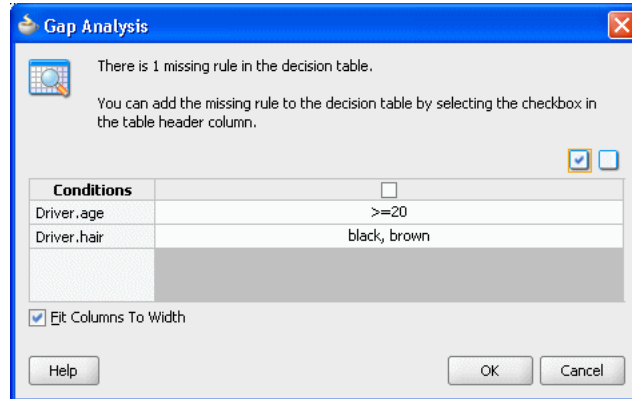
Gap checking generates different new rules for the following cases:

- Sibling rules: multiple missing sibling rules are added as a single new rule. For example, consider a rule with two conditions, `Driver.age` and `Driver.hair`. When there are two missing rules for different hair colors and the rules are siblings, that is, they have a common parent, then gap checking shows a single rule as shown in [Figure 5-15](#).

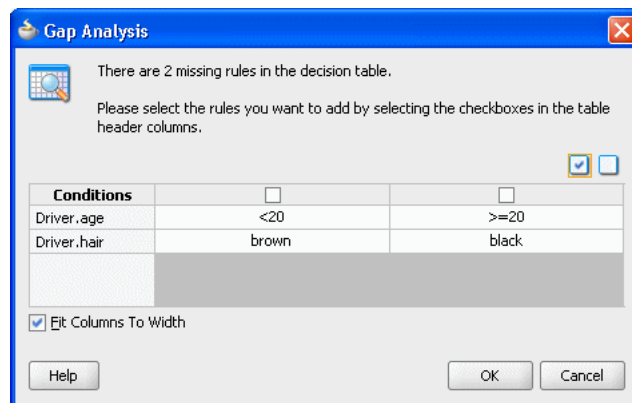


- Non-sibling rules: multiple missing non-sibling rules are added as individual new rules. For example, when there are two different rules missing that do not have the same parent, then gap checking provides two rules, as shown in [Figure 5–16](#).

**Figure 5–15** Gap Checking with Missing Sibling Rules



**Figure 5–16** Gap Checking with Missing Non-Sibling Rules



In both of these cases shown in [Figure 5–15](#) and [Figure 5–16](#) there are two missing buckets, but for sibling rules the multiple buckets are combined in a single new rule. Thus, in general gap checking suggests fewer more general rules in preference to many more specific rules.

For sibling rules you can add multiple rules then edit each cell to pick the buckets you want. Alternatively, you can use **Find Gaps** to add a rule and then split the cell with multiple values, and delete the rules you do not want to keep.

#### 5.3.1.4 Understanding Decision Table Conflict Analysis

The rules in a Decision Table can conflict. Two rules conflict when they overlap and they have different actions. Two rules overlap when at least one of their condition cells has a bucket in common. Overlap is common when a Decision Table contains "do not care" condition cells. Overlap without conflict is common and harmless.

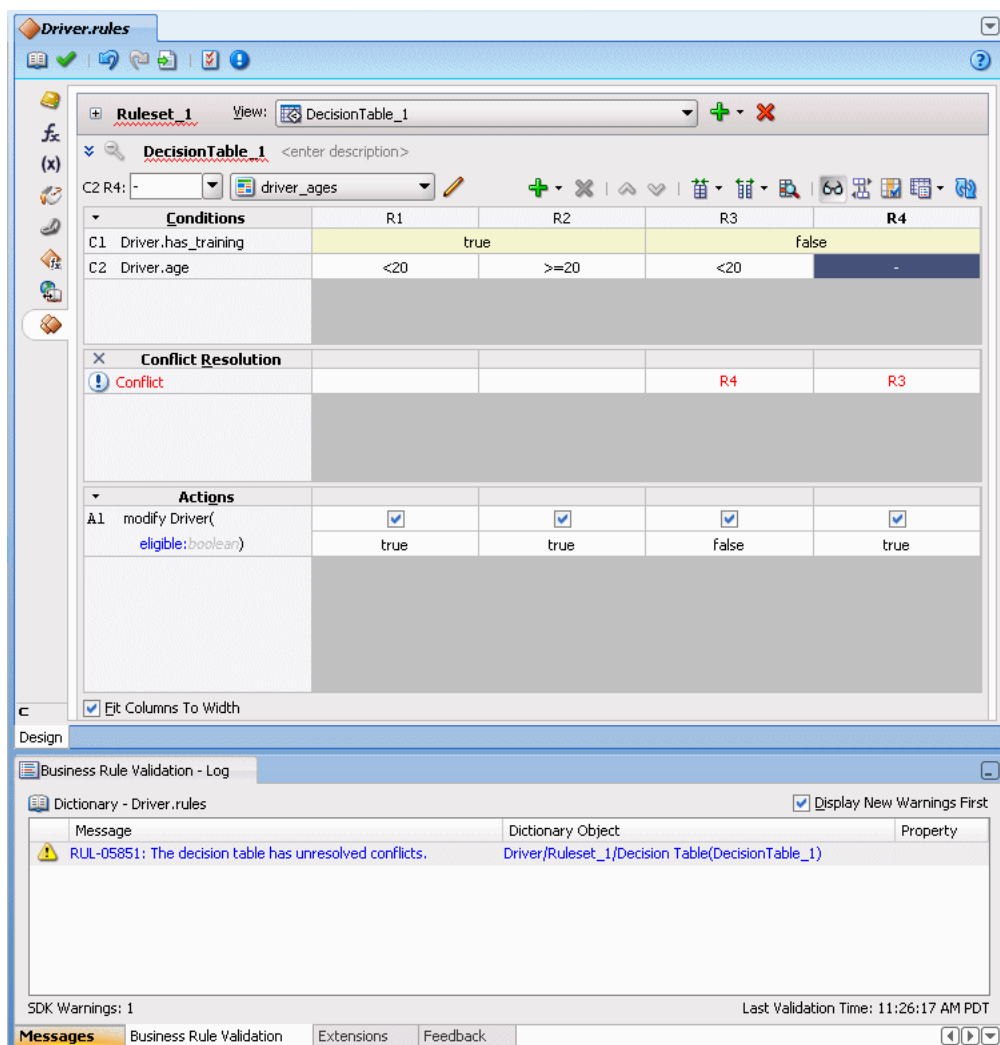
Rules Designer finds conflicts and you can see the conflicts in the **Conflict Resolution** row in the Decision Table when you click **Show Conflicts**. How you handle and resolve conflicts depends on the specified conflict policy. You can choose a conflict policy or use the default manual conflict policy. When you set a conflict policy using the **Conflict Policy** option in the **Advanced Settings** area, Rules Designer sets the

conflict policy for the Decision Table. The **Conflict Policy** specifies the Decision Table conflict policy and is one of the following:

- **manual:** Conflicts are resolved by manually specifying a conflict resolution for each conflicting rule.
- **auto override:** Conflicts are resolved automatically using an override conflict resolution when this is possible, using the Oracle Business Rules automatic conflict resolution policies.
- **ignore:** Conflicts are ignored.

For more information, see [Section 4.5, "Using Advanced Settings with Rules and Decision Tables"](#). For example, [Figure 5–17](#) shows a Decision Table with conflicting rules that you resolve with the default manual conflict policy.

**Figure 5–17 Decision Table Showing Conflicting Rules in the Conflicts Area**



By clicking on the cells in the Decision Table **Conflict Resolution** area Rules Designer lets you resolve conflicts between rules as follows:

- **Override (Override and OverriddenBy):** You override one rule with the other. Override specifies that one rule fires. Override is a combination of prioritization and mutual exclusion. Prioritization is transitive and not symmetric. Mutual

exclusion is both transitive and symmetric. If A overrides C and B overrides C, then A or B runs before C but only one of A, B, or C runs.

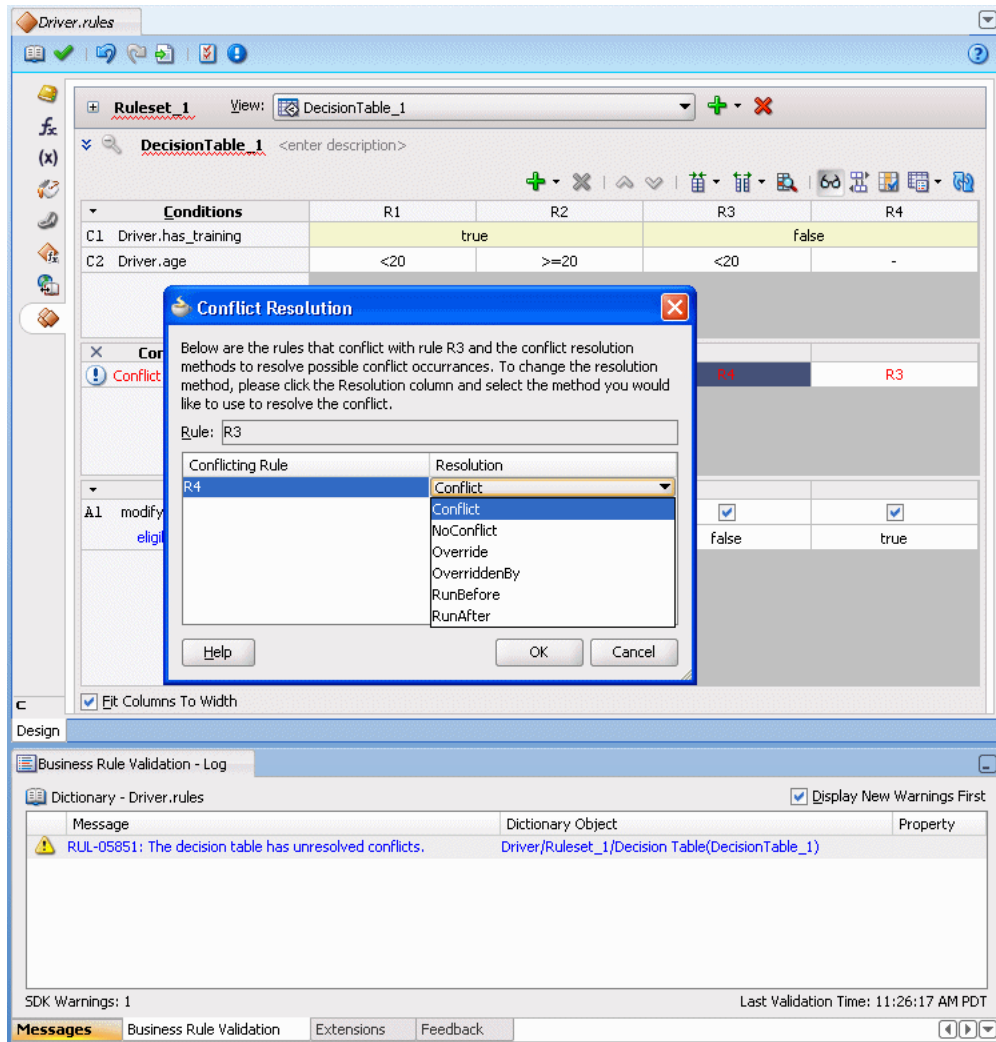
- **Run Before (RunBefore and RunAfter):** You prioritize the rules. Run before lets the two rules fire in a prescribed order. Prioritization is transitive but not symmetric. That is, if A runs before B runs before C, then A runs before C but B does not run before A. This uses a Decision Table runBefore list specifying that the rule that runs before has a higher priority than rules in the list.
- **Ignore (NoConflict):** You OK the conflict. Ignore lets the two rules fire in arbitrary order. For example, consider the following conflicting rules in a decision table:

```
rule1: everybody gets a 10% raise (as specified with a do not care value in a  
decision table condition cell)  
rule2: employee with Top Performer set to true gets a 5% raise
```

In these rules, if rule2 overrides rule1, then a top performer gets a 5% raise, and everyone else gets a 10% raise. However, in this case, you would like to have both rules fire. Because it does not matter which rule fires first, and there is no conflict, then a top performer gets a 15.5% raise either way. In this case, use the NoConflict list to remove the conflict. Note that no conflict is what you get with IF/THEN rules with equal priorities, only you are not warned of a conflict and you have to think carefully if you want one rule to override the other.

Figure 5–18 shows the Rules Designer Conflict Resolution dialog shown when you select a conflicting rule in the **Conflict Resolution** area. This dialog lets you resolve conflicts between rules by selecting overrides, prioritization with RunBefore or RunAfter options, and a NoConflict option.

**Figure 5–18 Using the Decision Table Conflict Resolution Dialog**



You can use the Decision Table Advanced Settings **Conflict Policy auto override** option to specify that, where possible, conflicts are automatically resolved. The automatic override conflict resolution policy specifies that a special case overrides a more general case. For more information, see [Section 4.5, "Using Advanced Settings with Rules and Decision Tables"](#).

Thus, when there are conflicts in a Decision Table, you can do one or more of the following to resolve the conflicts:

- Use auto override conflict resolution by selecting the **Conflict Policy** and then **auto override** option in the Decision Table.
- Ignore conflicts by selecting the **Conflict Policy** and then **ignore** option in the Decision Table.
- Use manual conflict resolution by selecting the **Conflict Policy** and then **manual** option in the Decision Table and set Conflict Resolution for each conflicting rule in the dialog by selecting cells in the **Conflict Resolution** area with the **Show Conflicts** checkbox selected.
- Change the Decision Table to remove an overlap.
- Combine actions to remove conflicts.

### 5.3.2 How to Compact or Split a Decision Table

Use the **Compact Table** and **Split Table** icons to compact or split cells in a Decision Table. For more information, see [Section 5.3.1.1, "Understanding Decision Table Split and Compact Operations."](#)

**To compact a decision table:**

1. In Rules Designer select a ruleset from the **Rulesets** navigation tab and select the Decision Table to compact.
2. Click the **Compact Table** icon.

**To split cells in a decision table:**

1. From Rules Designer select a ruleset from the **Rulesets** navigation tab and select the Decision Table to split.
2. Click the **Split Table** icon.

### 5.3.3 How to Merge or Split Conditions in a Decision Table

Use the merge condition and split condition operations to merge or split a condition in a Decision Table. For more information, see [Section 5.3.1.1, "Understanding Decision Table Split and Compact Operations."](#)

**To merge a condition in a decision table:**

1. From Rules Designer select a ruleset from the **Rulesets** navigation tab and select the Decision Table where you want to merge a condition.
2. In the **Conditions** area, select the condition you want to merge.
3. Right-click, and from the list select **Merge Condition**.

**To split a condition in a decision table:**

1. From Rules Designer select a ruleset from the **Rulesets** navigation tab and select the Decision Table where you want to split a condition.
2. In the **Conditions** area, select the condition you want to split.
3. Right-click and from the list select **Split Condition**.

### 5.3.4 How to Merge, Split, and Specify Do Not Care for Condition Cells

Use the condition cell operations to split a condition cell, to merge sibling condition cells, or to specify a "do not care" value for a condition cell in a Decision Table. For more information, see [Section 5.3.1.1, "Understanding Decision Table Split and Compact Operations."](#)

**To merge sibling cells in a condition in a decision table:**

1. From Rules Designer select a ruleset from the **Rulesets** navigation tab and select the Decision Table where you want to merge condition cells.
2. Select the sibling condition cells to merge.
3. Right-click, and from the list select **Merge selected cells**.

**To split a cell in a condition in a decision table:**

1. From Rules Designer select a ruleset from the **Rulesets** navigation tab and select the Decision Table where you want to split a condition cell.

2. Select the cell to split.
3. Right-click, and from the list select **Split selected cell**.

**To specify a "Do Not Care" value for a cell in a condition in a decision table:**

1. From Rules Designer select a ruleset from the **Rulesets** navigation tab and select the Decision Table where you want to set the "do not care" value.
2. Select the appropriate condition cell.
3. Right-click, and from the list select **Do Not Care**.

**To select all buckets to specify a "Do Not Care" value for a cell in a condition:**

1. From Rules Designer select a ruleset from the **Rulesets** navigation tab and select the Decision Table where you want to set the "do not care" value.
2. Select the appropriate condition cell.
3. Double-click, and from the list select all the available checkboxes for all possible values.

### 5.3.5 How to Perform Decision Table Gap Checking

A gap is a "missing" rule in a Decision Table. A Decision Table has a gap if there is a combination of buckets, one from each condition, that is not covered by an existing rule. Rules Designer provides Gap Checking to check for gaps. When you use this operation Rules Designer presents a window to fix gaps. For more information, see [Section 5.3.1.3, "Understanding Decision Table Gap Checking"](#).

You can choose to make existence of gaps a validation warning. When you deselect **Allow Gaps** in the **Advanced Settings** area, the Decision Table reports a validation warning when a gap is found. For more information, see [Section 4.5, "Using Advanced Settings with Rules and Decision Tables"](#).

**To perform decision table gap checking:**

1. From Rules Designer select a ruleset from the **Rulesets** navigation tab and select the Decision Table where you want to perform.
2. Click the **Gap Analysis** icon.

### 5.3.6 How to Perform Decision Table Manual Conflict Resolution

The rules in a Decision Table can conflict. Two rules conflict when they overlap and they have different actions. Two rules overlap when at least one of their condition cells has a bucket in common. For more information, see [Section 5.3.1.4, "Understanding Decision Table Conflict Analysis"](#).

**To perform manual decision table conflict resolution:**

1. From Rules Designer select a ruleset from the **Rulesets** navigation tab and select the Decision Table where you want to check conflicts.
2. Set the conflict policy to **manual** (this is the default conflict policy). For more information, see [Section 5.3.1.4, "Understanding Decision Table Conflict Analysis"](#).
3. In the **Conditions** area, in the conflicts area, when conflicts exist for each rule with a conflict double-click the appropriate condition cell to display the Conflict Resolution dialog.

4. In the Conflict Resolution dialog, for each conflicting rule, in the Resolution field select a resolution from the list.

### 5.3.7 How to Set the Decision Table Auto Override Conflict Resolution Policy

When you select the Advanced Settings option in a Decision Table, you can select that Decision Table conflicts are automatically resolved using the **auto override** conflict policy (this applies only when it is possible to resolve the conflict using the Oracle Business Rules automatic conflict resolution policies). The automatic override conflict resolution uses a policy where when there is a rule conflict a special case overrides a more general case. For more information, see [Section 5.3.1.4, "Understanding Decision Table Conflict Analysis"](#).

**To select the auto override policy:**

1. Select the rule or Decision Table where you want to use ignore conflict policy.
2. Click the **Show Advanced Settings** icon next to the rule or Decision Table name.
3. From the **Conflict Policy** option select **auto override**.

### 5.3.8 How to Set the Decision Table Ignore Conflicts Policy

When you select the Advanced Settings option in a Decision Table, you can select that the Decision Table conflicts are ignored using the **ignore** conflict policy. The ignore policy tells Oracle Business Rules to ignore conflicts in the Decision Table. For more information, see [Section 5.3.1.4, "Understanding Decision Table Conflict Analysis"](#).

**To select the ignore conflict policy:**

1. Select the rule or Decision Table where you want to use the ignore conflicts policy.
2. Click the **Show Advanced Settings** icon next to the rule or Decision Table name.
3. From the **Conflict Policy** option select **ignore**.

## 5.4 Creating and Running an Oracle Business Rules Decision Table Application

The Order Approval application demonstrates the integration of a SOA composite application with Oracle Business Rules and the use of a Decision Table.

In this application a process is modeled that uses the decision component to:

- Process rules from XML inputs including: a credit score and the annual spending of a customer, and the total cost of the incoming order.
- Provide output that determines if an order is approved, rejected, or requires manual processing.

To complete this procedure, you need to:

- Obtain the Source Files for the Order Approval Application
- Create an Application for Order Approval
- Create a Business Rule Service Component for Order Approval
- View Data Model Elements for Order Approval
- Add Bucketsets to the Data Model for Order Approval
- Associate Bucketsets with Order and CreditScore Properties



- Add a Decision Table for Order Approval
  - Split the Cells in the Decision Table and Add Actions
  - Compact the Decision Table
  - Replace Several Specific Rules with One General Rule
  - Add a General Rule
- Check Dictionary Business Rule Validation Log for Order Approval
- Deploy the Order Approval Application
- Test the Order Approval Application

### 5.4.1 How to Obtain the Source Files for the Order Approval Application

The source code for Oracle Business Rules-specific samples and SOA samples are available online in the Oracle SOA Suite samples page.

To work with the Order Approval application, you first need to obtain the `order.xsd` schema file either from the sample project that you obtain online or you can create the schema file and create all the application, project, and other files in Oracle JDeveloper. You can save the schema file provided in [Example 5-1](#) locally to make it available to Oracle JDeveloper.

[Example 5-1](#) shows the `order.xsd` schema file.

#### **Example 5-1 Order.xsd Schema**

```
<?xml version="1.0" ?>
<schema attributeFormDefault="qualified" elementFormDefault="qualified"
  targetNamespace="http://example.com/ns/customerorder"
  xmlns:tns="http://example.com/ns/customerorder"
  xmlns="http://www.w3.org/2001/XMLSchema">
  <element name="CustomerOrder">
    <complexType>
      <sequence>
        <element name="name" type="string" />
        <element name="creditScore" type="int" />
        <element name="annualSpending" type="double" />
        <element name="value" type="string" />
        <element name="order" type="double" />
      </sequence>
    </complexType>
  </element>
  <element name="OrderApproval">
    <complexType>
      <sequence>
        <element name="status" type="tns:Status"/>
      </sequence>
    </complexType>
  </element>
  <simpleType name="Status">
    <restriction base="string">
      <enumeration value="manual"/>
      <enumeration value="approved"/>
      <enumeration value="rejected"/>
    </restriction>
  </simpleType>
</schema>
```



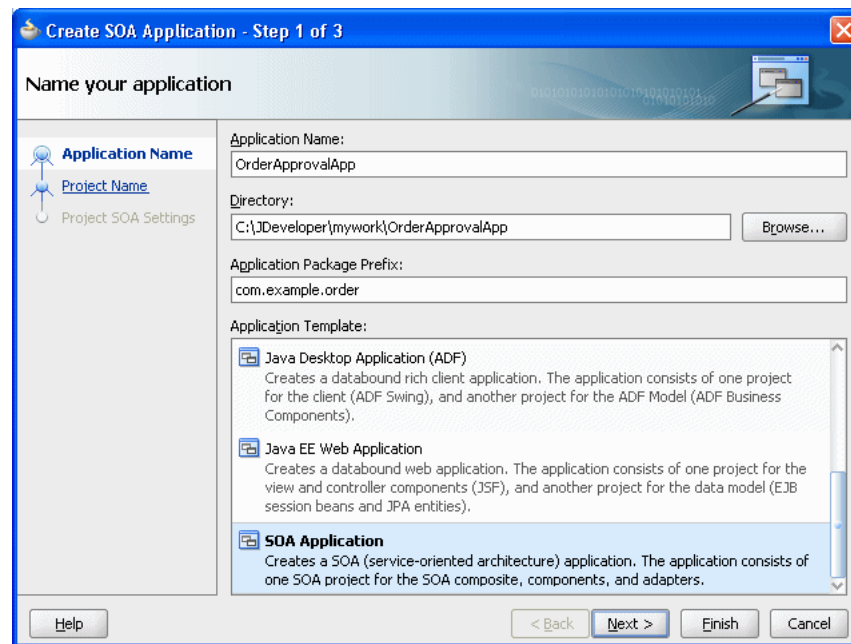
## 5.4.2 How to Create an Application for Order Approval

To work with Oracle Business Rules, you first create an application in Oracle JDeveloper.

### To create an application for order approval:

1. In the Application Navigator, click **New Application**.
2. In the Name your application dialog, enter the name and location for the new application.
  - a. In the **Application Name** field, enter an application name. For example, enter `OrderApprovalApp`.
  - b. In the **Directory** field, specify a directory name or accept the default.
  - c. In the **Application Package Prefix** field, enter an application package prefix, for example `com.example.order`.  
The prefix, followed by a period, applies to objects created in the initial project of an application.
  - d. For a SOA composite with Oracle Business Rules, in the Application Template area select SOA Application for the application template. For example, see [Figure 5–19](#).
  - e. Click **Next**.

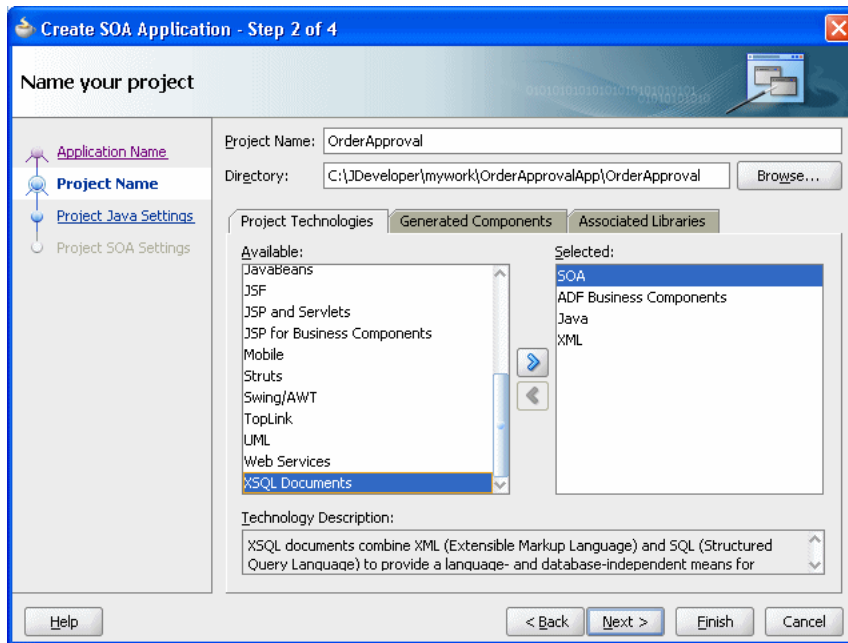
**Figure 5–19 Adding the Order Approval Application**



3. In the Name your project page enter the name and location for the project.
  - a. In the **Project Name** field, enter a name. For example, enter `OrderApproval`.
  - b. Enter or browse for a directory name, or accept the default.
  - c. For an Oracle Business Rules project, in the **Project Technologies** area ensure that SOA, ADF Business Components, Java, and XML are in the **Selected** area on the Project Technologies tab, as shown in [Figure 5–20](#). If an item is missing,

select it in the **Available** pane and add it to the **Selected** pane using the **Add** button.

**Figure 5–20 Adding a Project to an Application**



4. Click **Finish**.

### 5.4.3 How to Create a Business Rule Service Component for Order Approval

After creating a project in Oracle JDeveloper you need to create a Business Rule Service component within the project. When you add a business rule you can create input and output variables to provide input to the service component and to obtain results from the service component.

To use business rules with Oracle JDeveloper, you do the following:

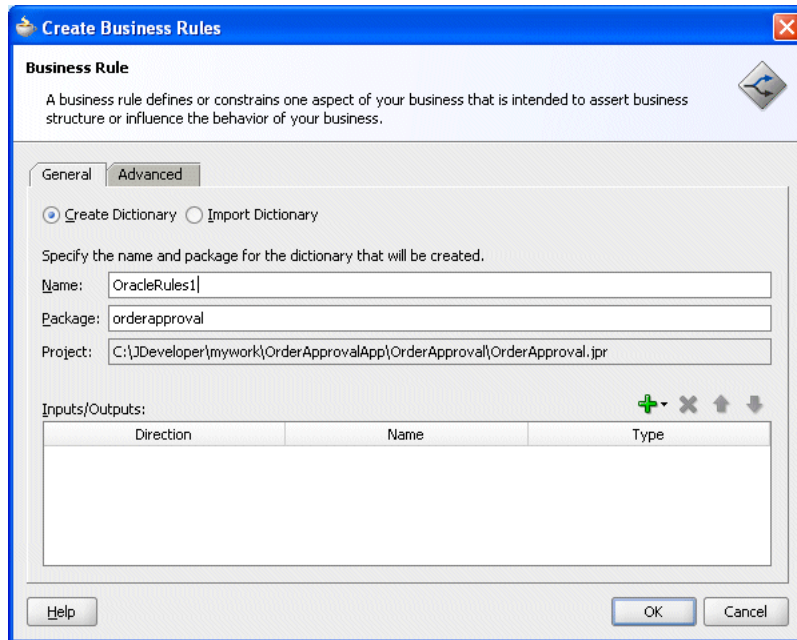
- Add a business rules service component
- Create input and output variables for the service component
- Create an Oracle Business Rules dictionary in the project

**To create a business rule service component:**

1. In the Application Navigator, in the **OrderApproval** project expand **SOA Content** and double-click `composite.xml` to launch the SOA composite editor (this may already be open after you create the project).
2. From the Component Palette, drag-and-drop a **Business Rule** from the **Service Components** area of the SOA menu to the **Components** lane of the `composite.xml` editor.

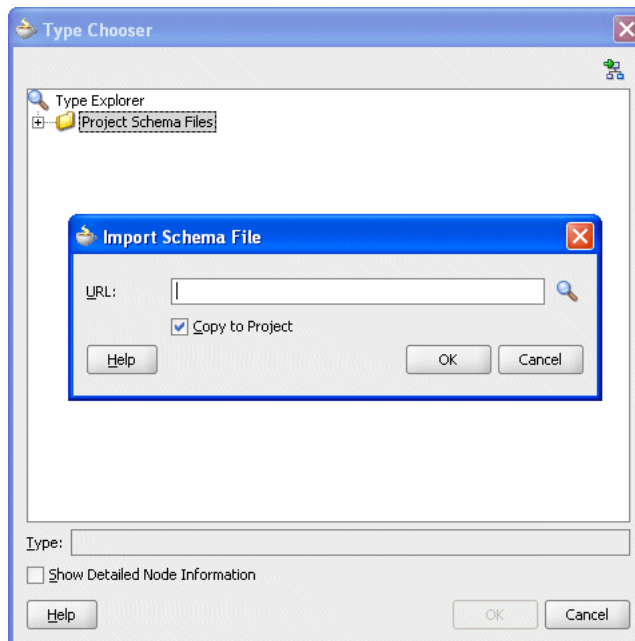
Oracle JDeveloper displays a Create Business Rules page, as shown in [Figure 5–21](#).

**Figure 5–21 Adding a Business Rule Dictionary with the Create Business Rules Dialog**



3. To add an input, from the list next to the **Add** icon select **Input** to enter input for the business rule.
4. In the Type Chooser dialog, click the **Import Schema File...** icon. This displays the Import Schema File dialog, as shown in [Figure 5–22](#).

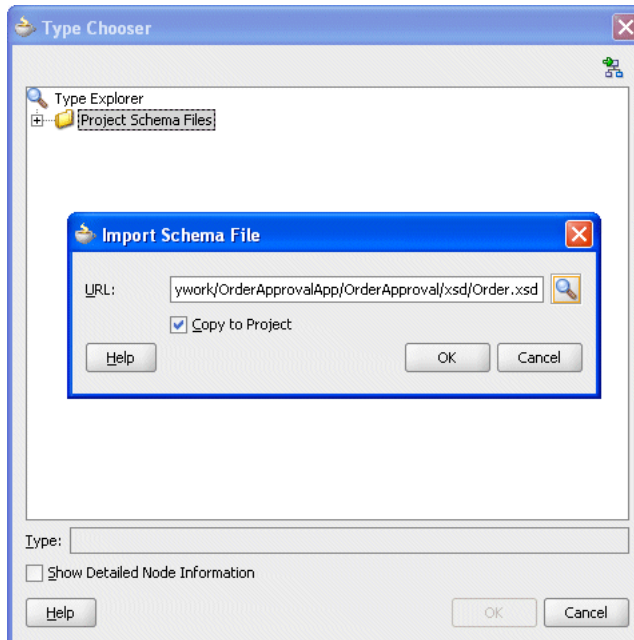
**Figure 5–22 Import Schema File with Type Chooser**



5. In the Import Schema dialog click **Browse Resources** to choose the XML schema elements for the input variable of the process. This displays the SOA Resource Lookup dialog.

6. In the SOA Resource Lookup dialog, navigate to find the `order.xsd` schema file and click **OK**.
7. In the Import Schema File dialog, make sure **Copy to Project** is selected, as shown in [Figure 5-23](#).

**Figure 5-23 Importing the Order.xsd Schema File**

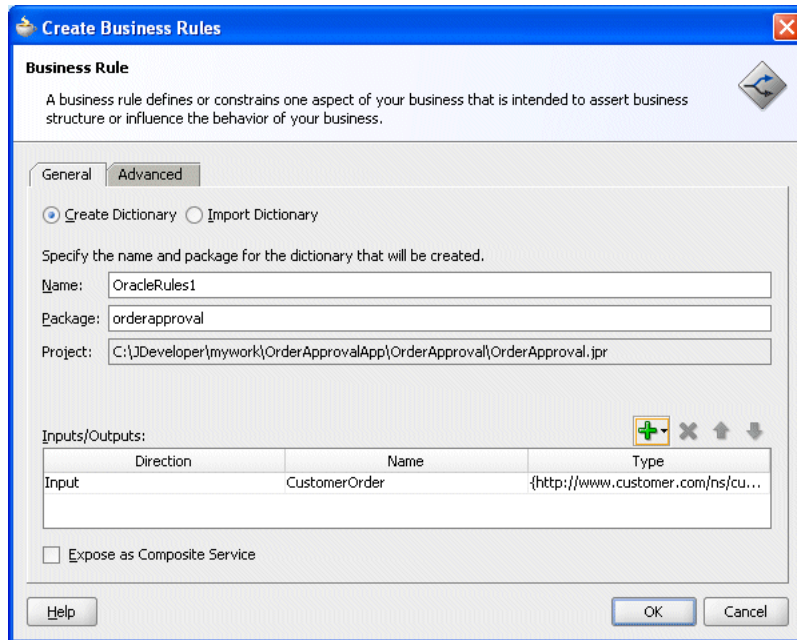


8. In the Import Schema File dialog, click **OK**.
9. If the Localize Files dialog displays, click **OK** to copy the schema to the composite process directory.
10. In the Type Chooser, navigate to the Project Schemas Files folder to select the input variable.

For this example, select `CustomerOrder` as the input variable.

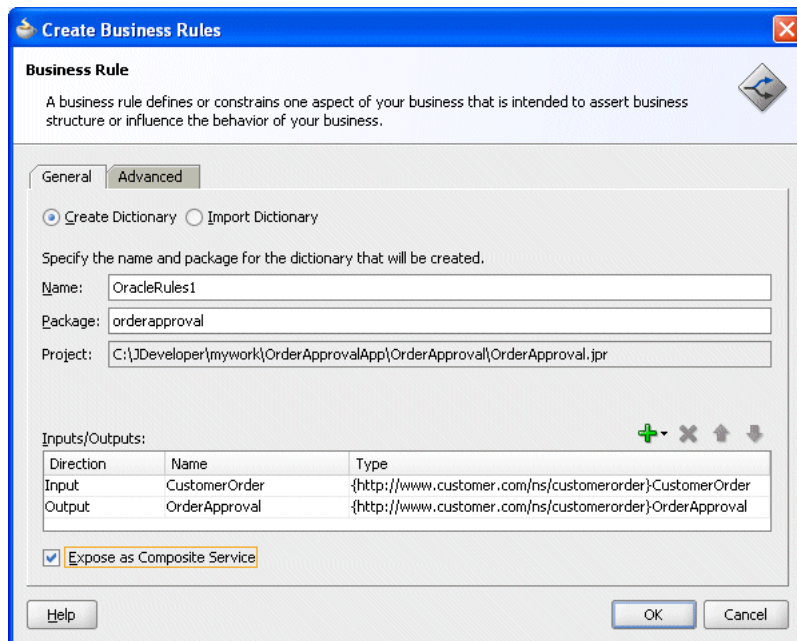
11. On the Type Chooser window, click **OK**. This displays the Create Business Rules dialog, as shown in [Figure 5-24](#).

**Figure 5–24 Create Business Rules Dialog with CustomerOrder Input**



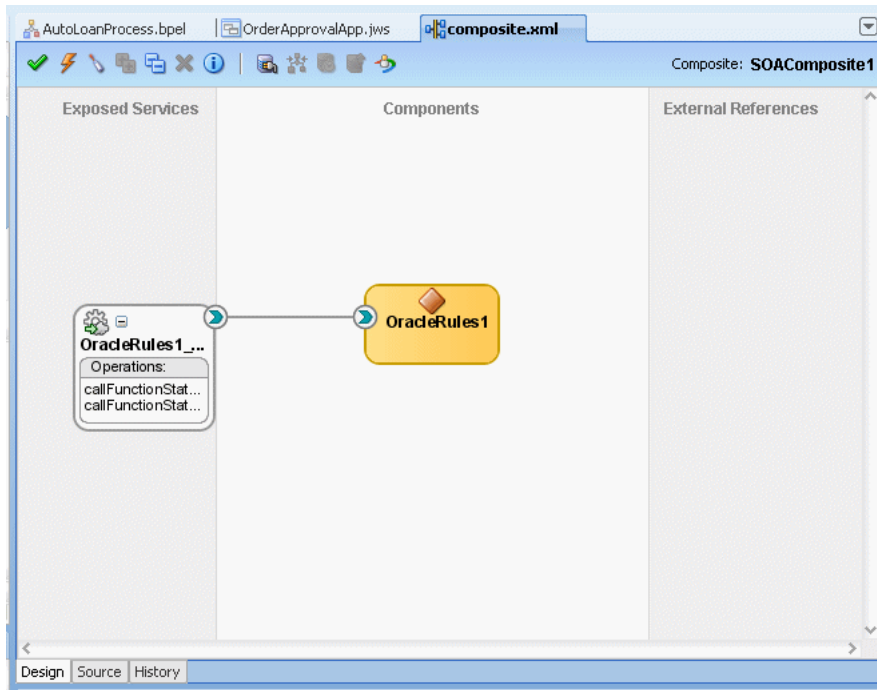
12. In a similar manner, add the output fact type `OrderApproval` from the imported `order.xsd`.
13. In the Create Business Rules dialog, select **Expose as Composite Service**, as shown in [Figure 5–25](#).

**Figure 5–25 Create Business Rules Dialog with Input and OrderApproval Output**



14. Click **OK**. This creates the Business Rule component and Oracle JDeveloper shows the Business Rule in the canvas workspace, as shown in [Figure 5–26](#).

**Figure 5–26 Business Rules Component in OrderApproval Composite**



The business rule service component enables you to integrate your SOA composite application with a business rule. This creates a business rule dictionary and enables you to execute business rules and make business decisions based on the rules.

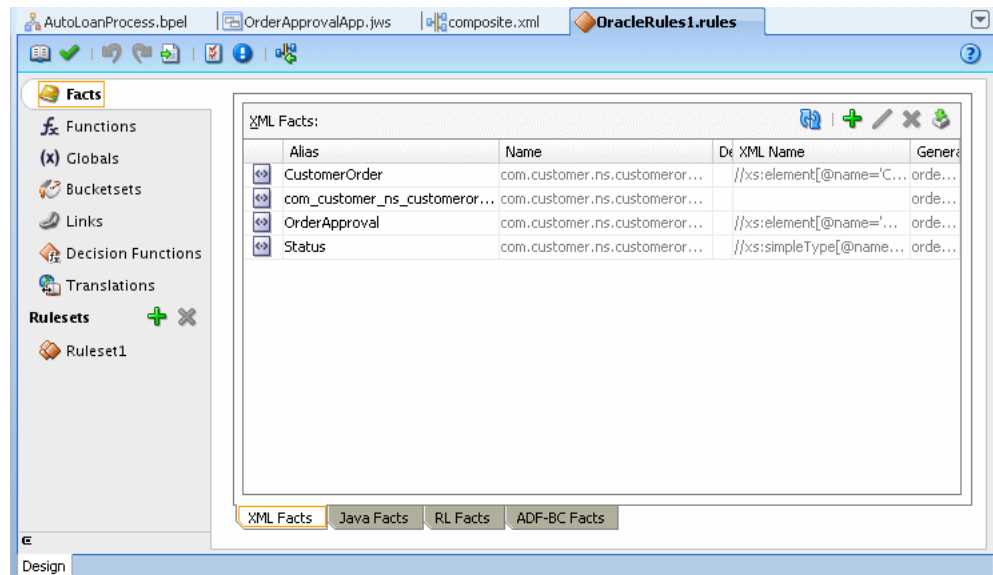
#### 5.4.4 How to View Data Model Elements for Order Approval

Before adding rules you need to create the Oracle Business Rules data model. The data model contains the business data definitions (types) and definitions for facts that you use to create rules. For example, for this sample the data model includes the XML schema elements from `order.xsd` that you specify when you define inputs and outputs for the business rule activity.

At times when you work with Rules Designer to create a rule or a Decision Table, you may need to create or modify elements in the data model.

##### To view data model elements for Oracle business rules:

1. Select the composite tab with the value **composite.xml**, and in the Components pane select the business rule (this surrounds the component, **OracleRules1** with a dashed selection box).
2. Double-click the selection box to launch Rules Designer.
3. In Rules Designer select the **Facts** navigation tab.
4. Select **XML Facts** tab in the **Facts** navigation tab as shown in [Figure 5–27](#).

**Figure 5–27 Opening a Business Rules Dictionary with Rules Designer**

### 5.4.5 How to Add Bucketsets to the Data Model for Order Approval

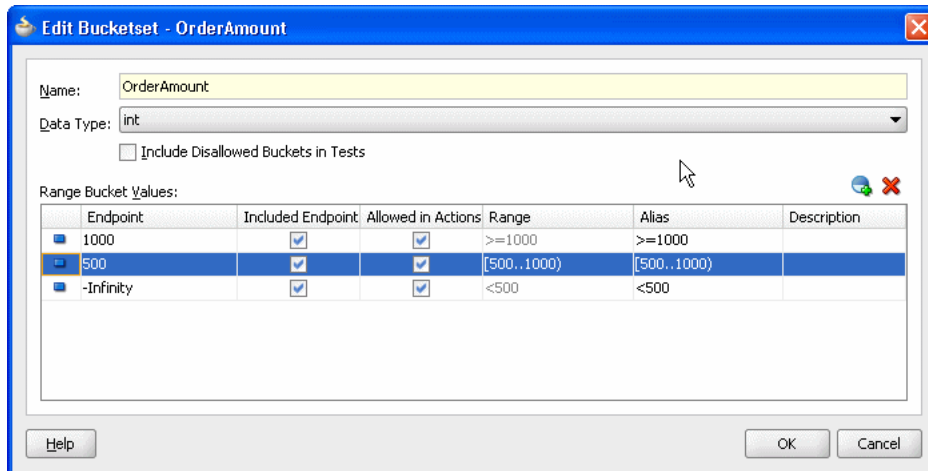
To use a Decision Table you need to define bucketsets that specify how to draw values for each cell for the conditions that constitute the Decision Table. For this example the bucketsets are defined with a list of ranges that you define in Rules Designer.

#### To add OrderAmount bucketset to the data model:

1. In Rules Designer, select the **Bucketsets** navigation tab.
2. From the dropdown next to the **Create BucketSet...** icon, select **List of Ranges**.
3. In the **Name** field, enter `OrderAmount` (In Rules Designer be sure to press **Enter** to accept the name).
4. Double-click the **OrderAmount** bucketset icon to display the Edit Bucketset dialog.
5. Click **Add Bucket** to add a bucket.
6. Click **Add Bucket** again to add another bucket.
7. In the **Range Bucket Values** area, in the top **Endpoint** field enter 1000 for the endpoint value.
8. In the **Range Bucket Values** area, for the middle bucket in the **Endpoint** field enter 500 for the endpoint value.
9. In the **Included Endpoint** field for each bucket ensure the checkbox is selected, as shown in [Figure 5–28](#).

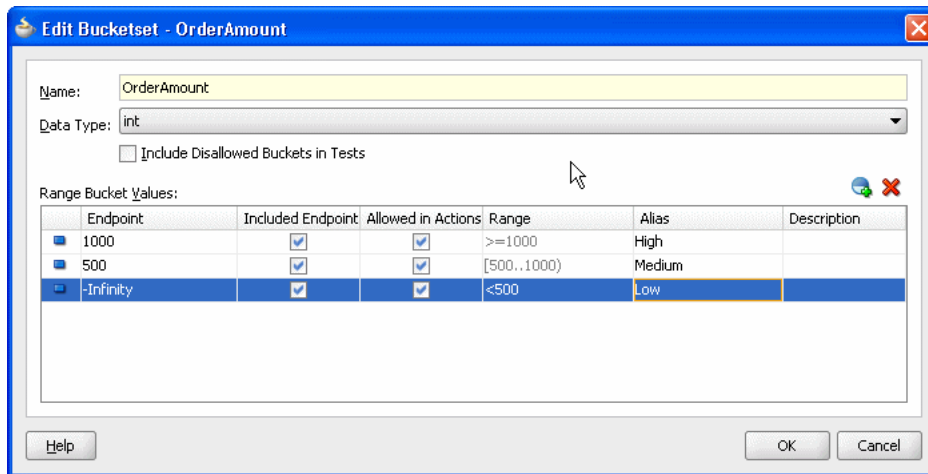


**Figure 5–28 Adding the OrderAmount Bucketset**



10. Modify the **Alias** field for each value to **High, Medium, and Low**, as shown in [Figure 5–29](#).

**Figure 5–29 Adding the OrderAmount Bucketset with Low Medium and High Aliases**



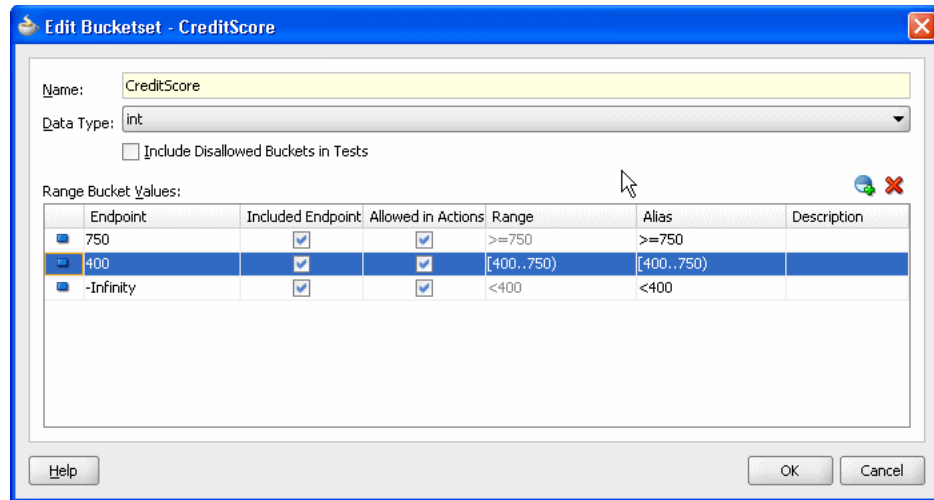
11. Click **OK**.

**To add CreditScore bucketset to data model:**

1. In Rules Designer select the **Bucketsets** navigation tab.
2. From the dropdown next to the **Create BucketSet...** icon, select **List of Ranges**.
3. In the **Name** field, enter **CreditScore**.
4. Double-click the **CreditScore** bucketset icon to display the Edit Bucketset dialog.
5. Click **Add Bucket** to add a bucket.
6. Click **Add Bucket** again to add another bucket.
7. In the top bucket, in the **Endpoint** field enter 750.
8. For the middle bucket, in the **Endpoint** field enter 400.
9. In the **Included Endpoint** field for each bucket, ensure the checkbox is selected as shown in [Figure 5–30](#).

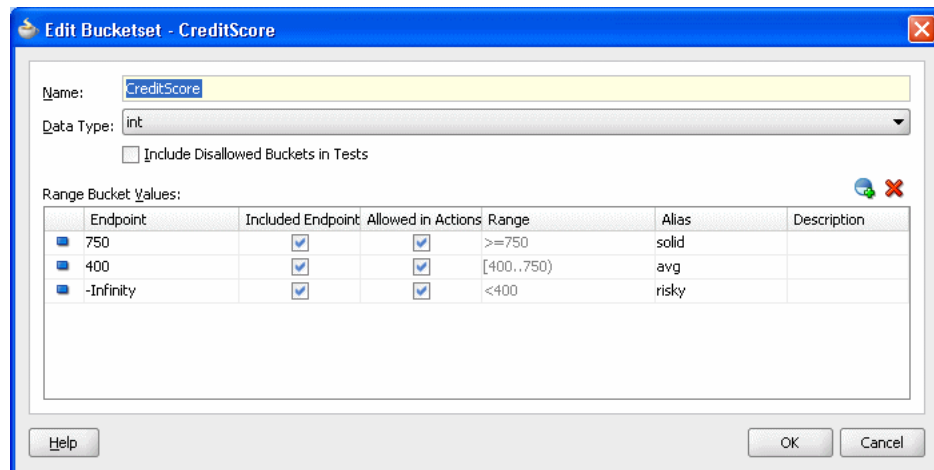


**Figure 5–30 Adding the CreditScore Bucketset**



10. Modify the **Alias** field for each endpoint value to **solid** for 750, **avg** for 400, and **risky** for -Infinity as shown in Figure 5–31.
11. Click **OK**.

**Figure 5–31 Adding the CreditScore Bucketset with Risky Avg and Solid Aliases**



### 5.4.6 How to Associate Bucketsets with Order and CreditScore Properties

To prepare for creating Decision Tables you can associate a bucketset with fact properties in the data model. In this way condition cells in a Decision Table **Conditions** area can use the bucketset when you create a Decision Table.

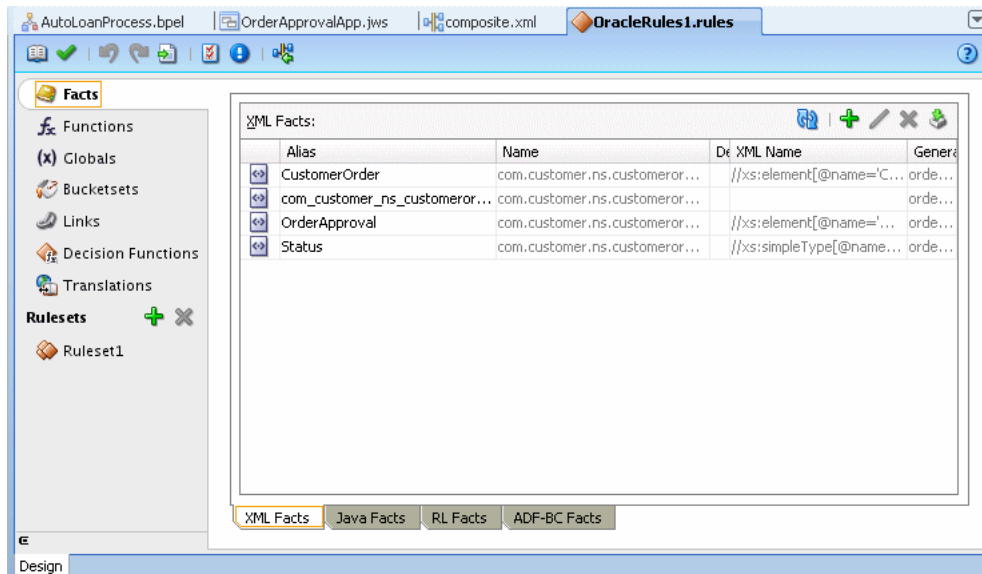
Note that the `OrderApproval.status` property is associated with the `Status` bucketset when the `OrderApproval` fact type is imported from the XML schema. In the schema, `Status` is a restricted `String` type and is therefore represented as an enum bucketset. Rules Designer creates the `status` bucketset. For more information, see [Section 3.2.4, "What You Need to Know About XML Facts"](#).

**To associate bucketsets with Order and CreditScore properties:**

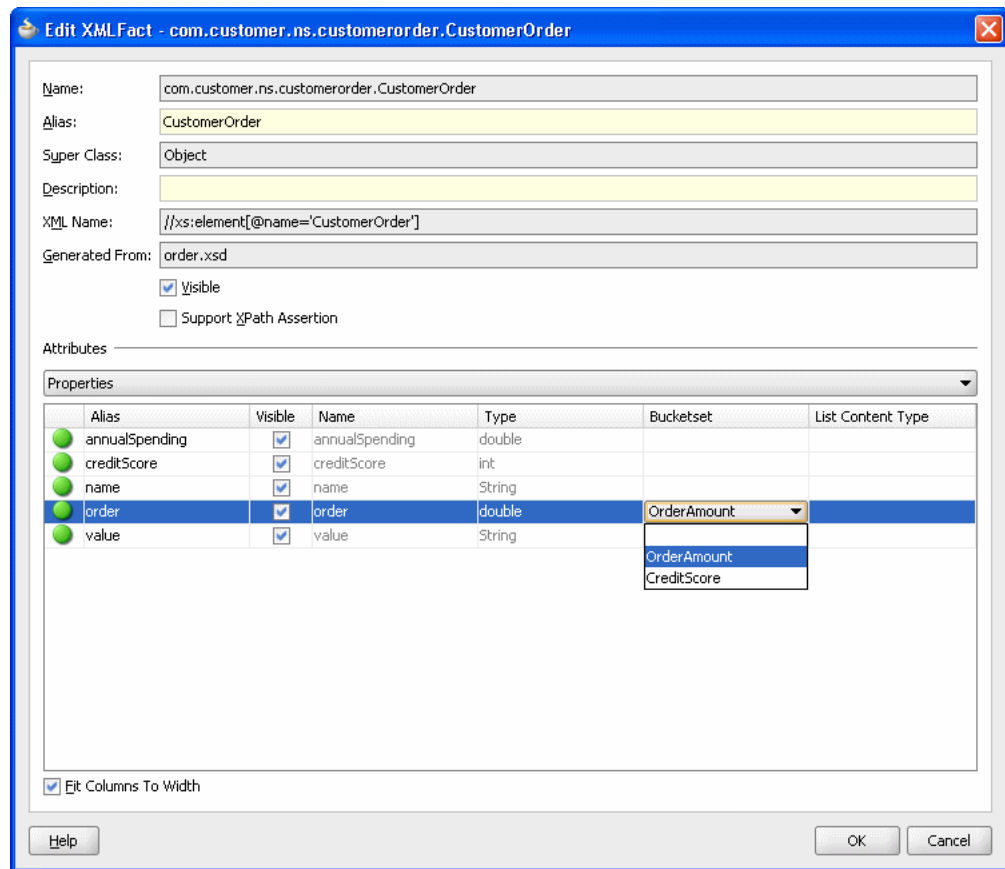
1. In Rules Designer select the **Facts** navigation tab.

2. Select the **XML Facts** tab in the **Facts** navigation tab as shown in [Figure 5–32](#).

**Figure 5–32** Opening a Business Rules Dictionary with Rules Designer



3. Select the type you want to modify. For example in the XML Facts table double-click the icon next to the **CustomerOrder** entry. This displays the Edit XML Fact dialog.
4. In the Edit XML Fact dialog, in the **Properties** table in the **Bucketset** column select the cell for the appropriate property and from the list select the bucketset you want to use. For example, for the property **order** select the **OrderAmount** bucketset, as shown in [Figure 5–33](#).

**Figure 5–33 Associating the OrderAmount Bucketset with CustomerOrder.order**

5. In a similar manner, for the property `creditScore` select the `CreditScore` bucketset.
6. Click **OK**.

### 5.4.7 How to Check the Business Rule Validation Log for Order Approval

Before you can deploy the application you need to make sure the dictionary validates without warnings. If there are any validation warnings you need fix any associated problems.

#### To validate the dictionary:

1. In the Business Rule Validation Log, check for validation warnings.
2. If there are validation warnings, perform appropriate actions to correct the problems.

### 5.4.8 How to Deploy the Order Approval Application

Business rules created in a SOA application are deployed as part of the SOA composite when you create a deployment profile in Oracle JDeveloper. You deploy a SOA composite application to Oracle WebLogic Server.

#### To deploy and run the order approval application:

1. If you have not started your application server instance, then start the Oracle WebLogic Server.

2. In the Application Navigator, right-click the **OrderApproval** project and select **Deploy > OrderApproval > to > WLS Server Name**.  
Then the SOA Deployment Configuration dialog displays.
3. Click **OK**.
4. In the Authorization Request dialog, enter your authorization.
5. Click **OK**.

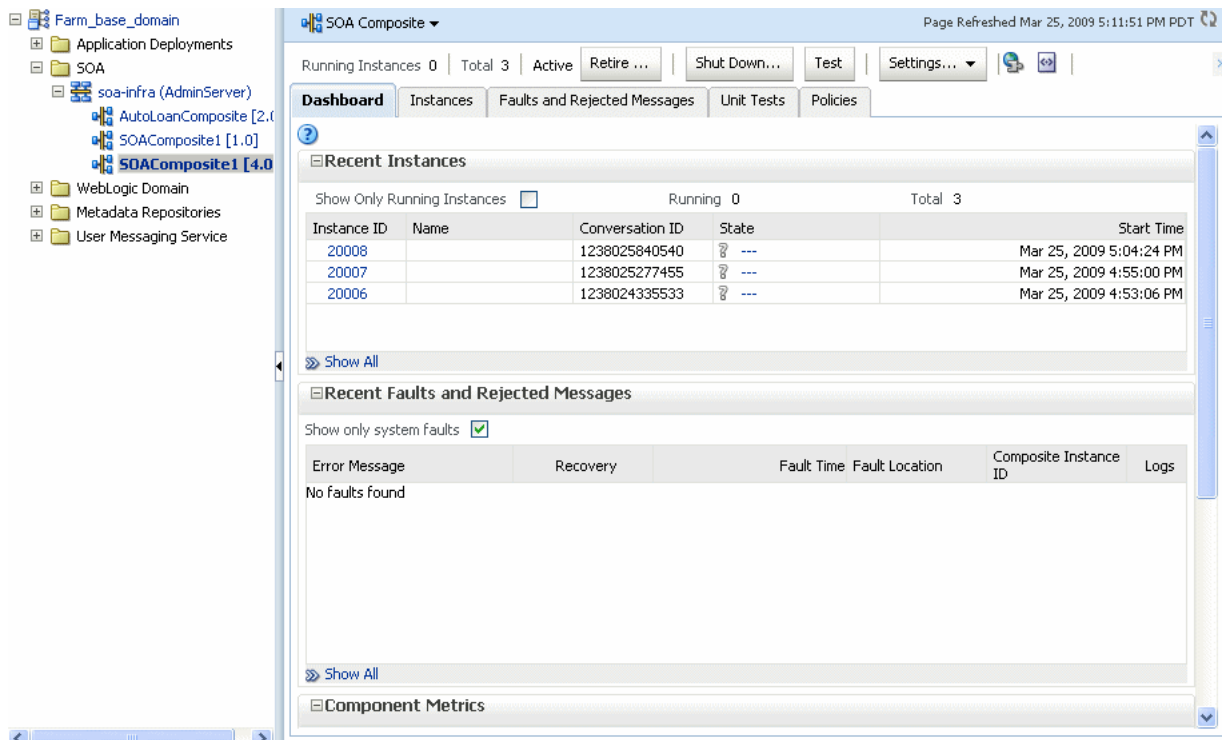
### 5.4.9 How to Test the Order Approval Application

After deploying the application you can test the Decision Table in the SOA composite application with the Oracle Enterprise Manager Fusion Middleware Control Console.

**To test the application:**

1. Open the composite application in Oracle Enterprise Manager Fusion Middleware Control Console, as shown in [Figure 5–34](#).

**Figure 5–34 Testing the Order Approval Application**



2. Click **Test**.
3. In the **Input Arguments** area, select **XML View**. Replace the XML with the contents of example [Example 5–2](#).

**Example 5–2 Sample Input for Testing Order Approval Application**

```
<soap:Envelope xmlns:soap="http://schemas.xmlsoap.org/soap/envelope/">
  <soap:Body xmlns:ns1="http://xmlns.oracle.com/OracleRules1/OracleRules1_DecisionService_1">
    <ns1:callFunctionStateless name="OracleRules1_DecisionService_1">
      <ns1:parameterList xmlns:ns3="http://example.com/ns/customerorder">
        <ns3:CustomerOrder>

```

```

        <ns3:name>Gary</ns3:name>
        <ns3:creditScore>600</ns3:creditScore>
        <ns3:annualSpending>2001.0</ns3:annualSpending>
        <ns3:value>High</ns3:value>
        <ns3:order>100.0</ns3:order>
    </ns3:CustomerOrder>
</ns1:parameterList>
</ns1:callFunctionStateless>
</soap:Body>
</soap:Envelope>

```

4. Replace the values in the input shown in [Example 5-2](#) as desired for your test.
5. Click **Test Web Service**.
6. In the **Response** tab, view the results. For example, for this input:

```

/OracleRules1_DecisionService_1" xmlns:ns2="http://xmlns.oracle.com/bpel">
  <resultList>
    <OrderApproval:OrderApproval
xmlns:OrderApproval="http://example.com/ns/customerorder"
xmlns="http://example.com/ns/customerorder">
      <status>approved</status>
    </OrderApproval:OrderApproval>
  </resultList>
</callFunctionStatefulDecision>

```



---

---

## Working with Decision Functions

This chapter describes how to use a decision function to call rules from a Java application, from a composite, or from a BPEL process.

The chapter includes the following sections:

- [Section 6.1, "Introduction to Decision Functions"](#)
- [Section 6.2, "Working with Decision Functions"](#)
- [Section 6.3, "What You Need to Know About Decision Functions"](#)

### 6.1 Introduction to Decision Functions

A decision function is a function that is configured declaratively.

A decision function contains the following declarations:

- input facts
- rulesets and nested decision functions
- output facts

A decision function performs the following operations:

- Asserts inputs as rule facts into the Oracle Business Rules Engine working memory
- Runs rulesets configured in the current decision function and in nested decision functions in order
- Returns output facts from the Oracle Business Rules Engine working memory

You can create a decision function to simplify the use of Oracle Business Rules from a Java application or from a BPEL process. In a decision function the rules you want to use can be organized into several rulesets, and those rulesets can be executed in a prescribed order. Facts may flow to the first ruleset, and this ruleset may assert additional facts that flow to the second and subsequent rulesets until finally facts flow back to the decision function as decision function output.

### 6.2 Working with Decision Functions

A decision function is a function that is configured declaratively.

#### 6.2.1 How to Add or Edit a Decision Function

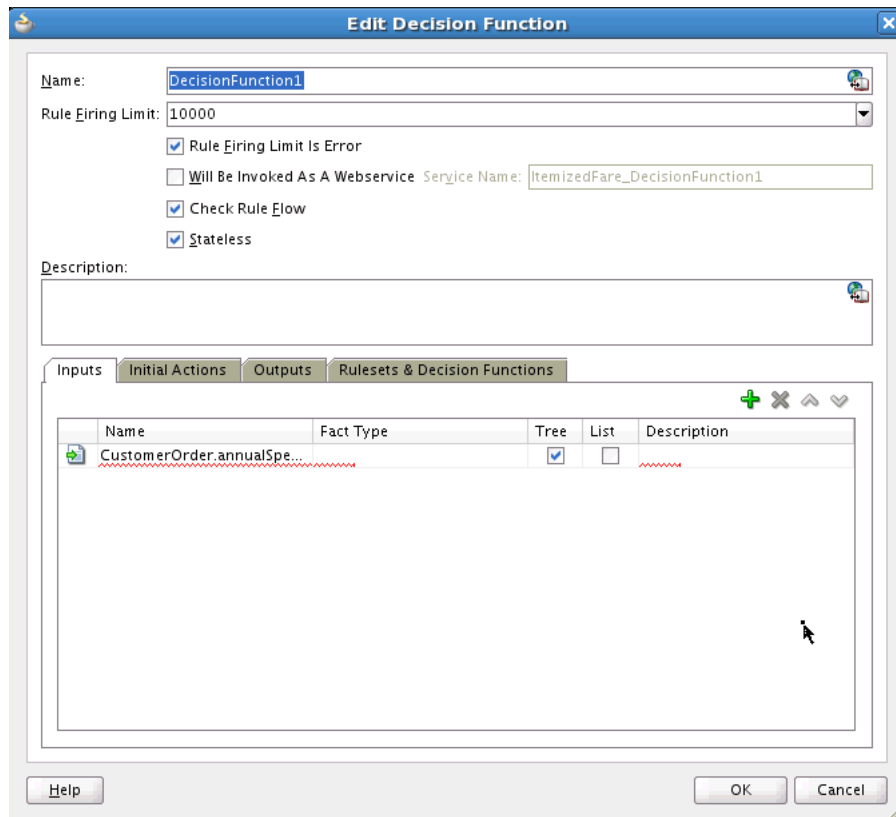
You use Rules Designer to add a decision function.

**To add a decision function:**

1. In Rules Designer, select the **Decision Functions** navigation tab.
2. In the **Decision Functions** area, click the **Create** icon.

A new Decision Function is created and an Edit Decision Function dialog is displayed, as shown in [Figure 6–1](#).

**Figure 6–1** *Edit Decision Function Dialog*



3. Enter a name for the Decision Function in **Name** field.
4. In the **Description** field, optionally enter a description.
5. In the **Rule Firing Limit** field, select **unlimited** or a value. In some cases when you are debugging a decision function, you may want to enter a value for the rule firing limit. For more information, see [Section 6.3.1, "What You May Need to Know About Rule Firing Limit Option for Debugging Rules"](#).
6. Select the **Rule Firing Limit is Error**. The system throws an error when the firing limit is reached.
7. Select the appropriate decision function options:
  - **Will be invoked as a Web Service:** select whether the decision function will be invoked as a Web Service and provide the Web Service name.
  - **Check Rule Flow:** when selected, this option specifies that the rule flow is checked to ensure that facts of the appropriate type are either explicit inputs to the decision function or are asserted by rules in the rule flow. However, when this is selected this does not always produce useful information; there are cases where facts can be asserted in Java code that uses the decision function,



but this code might not be available at design time. In this case, validation warnings may produced with Check Rule Flow selected may not be useful.

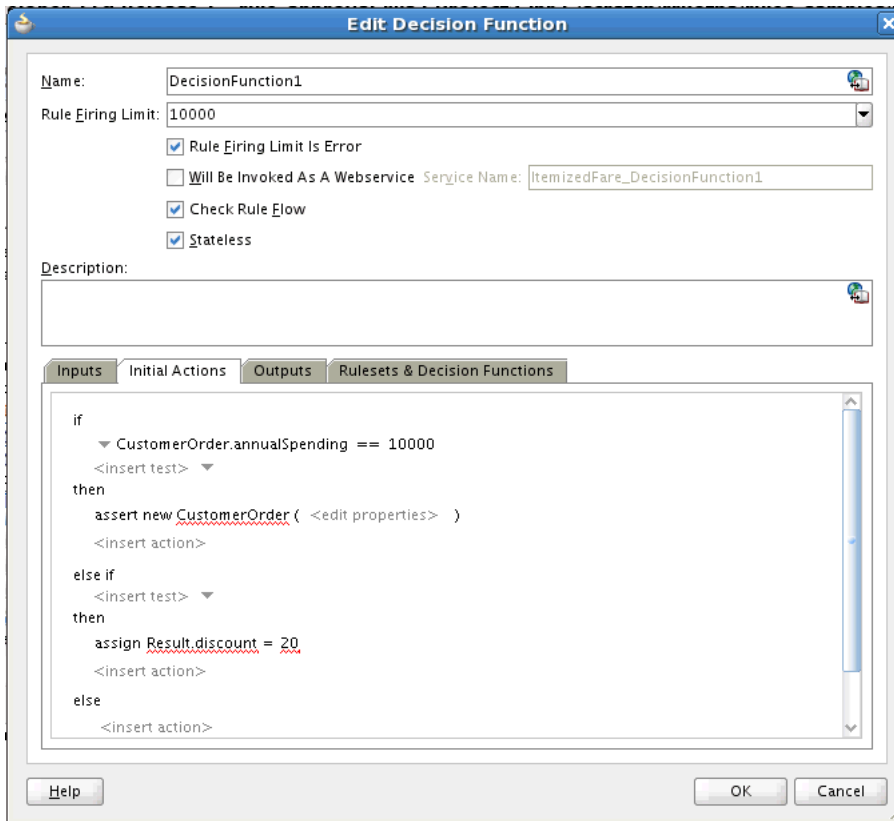
- **Stateless:** when selected specifies the decision function is stateless. For more information, see [Section 6.3.3, "What You May Need to Know About the Decision Function Stateless Option"](#).
- 8. In the Inputs tab, click **Add** to add inputs. For each input in the Inputs Table, select the appropriate options:
  - **Name** - enter an input name and press **Enter** or accept the default name.
  - **Fact Type** - select the appropriate fact type from the list.
  - **Tree** - When unselected, the input is asserted using the `assert` function. When selected, the input is asserted using the `assertTree` function. When selected it is expected that the input object or objects are the root of an object tree that is connected in one-to-many relationships with other objects using `List` properties. For more information, see [Section 4.8, "Working with Tree Mode Rules"](#).
  - **List** - When unselected, the input must be a single object and the assertion applies only to that single input object. When selected, the input must be a `List` of objects and the assertion applies to each object in the input `List` (`java.util.List`).
  - **Description** - Description of the input.
- 9. In the Outputs tab, click **Add** to add outputs. For each output in the Outputs Table, select the appropriate options:
  - **Name** - enter an output name and press **Enter** or accept the default name.
  - **Fact Type** - select the appropriate fact type from the list.
  - **Tree** - When selected, this option sets a flag that enables certain design-time decision function argument checking. For an output argument, this option has no effect on runtime behavior. However, at design time in the case where several decision functions are called in a sequence, it is useful to notate explicitly that the output of one decision function is a tree. This implies that the input of another decision function in the sequence is expecting a tree as an input. For more information, see [Section 4.8, "Working with Tree Mode Rules"](#).
  - **List** - When unselected the output is a single object. When selected the output is a group of objects. For more information on the behavior of the `List` option on an output argument, see [Section 6.3.2, "What You May Need to Know to About Decision Function Arguments"](#).
  - **Description** - Description of the output.
- 10. In the **Initial Actions** tab, you can add actions that could be used to change input facts before they are asserted, change the ruleset stack, set the effective date, or even assert output facts. These actions could be used instead of rules, or to "set up" the environment for running rules.

Consider a situation where a decision function (DF1) calls another decision function (DF2) using the **Initial Actions** tab. DF1 is configured to push Ruleset1 to the ruleset stack. DF2 is configured to push Ruleset2. In DF1, before the initial actions are executed, Ruleset1 is pushed to the ruleset stack. Then, when DF2 is called, Ruleset2 is also pushed. So when rules start running, rules from both rulesets fire because of the ruleset stack. If you want to push Ruleset2 (because in the initial actions, you are calling DF2), you can use initial actions in DF1 to clear

the ruleset stack before calling DF2, and push Ruleset1 on the stack after calling DF2.

You can add any required action ranging from `assert`, `call`, `modify` to even conditional actions such as `if`, `else`, `elseif`, `while`, `for`, `if (advanced)`, and `while (advanced)` as shown in [Figure 6–2](#).

**Figure 6–2 Adding Initial Actions**




---

**Note:** If decision function DF1 contains DF2 in the **Rulesets & Decision Functions** tab, then DF2 may not have any initial actions.

---

The `if (advanced)` and `while (advanced)` conditional actions accept only boolean values. For each of the action conditions, you can add different test form types.

11. In the **Rulesets and Decision Functions** area, use the shuttle to move items from the **Available** box to the **Selected** box.
12. Select an item in the **Selected** box, and click **Move Up** or **Move Down** as appropriate to order the rulesets and the decision functions.

**To edit an existing decision function:**

1. In Rules Designer, select the **Decision Functions** navigation tab.
2. Select the decision function to edit and click the **Edit** icon or double-click the decision function icon.
3. Edit the appropriate decision function fields in the same manner as you would when you add a decision function.

**To change the order of inputs:**

1. In Rules Designer, select the **Decision Functions** navigation tab.
2. Select the decision function to edit and click the **Edit** icon or double-click the decision function icon.
3. Select the input argument you want to move. Click either **Move Up** or **Move Down** to reorder the input argument.

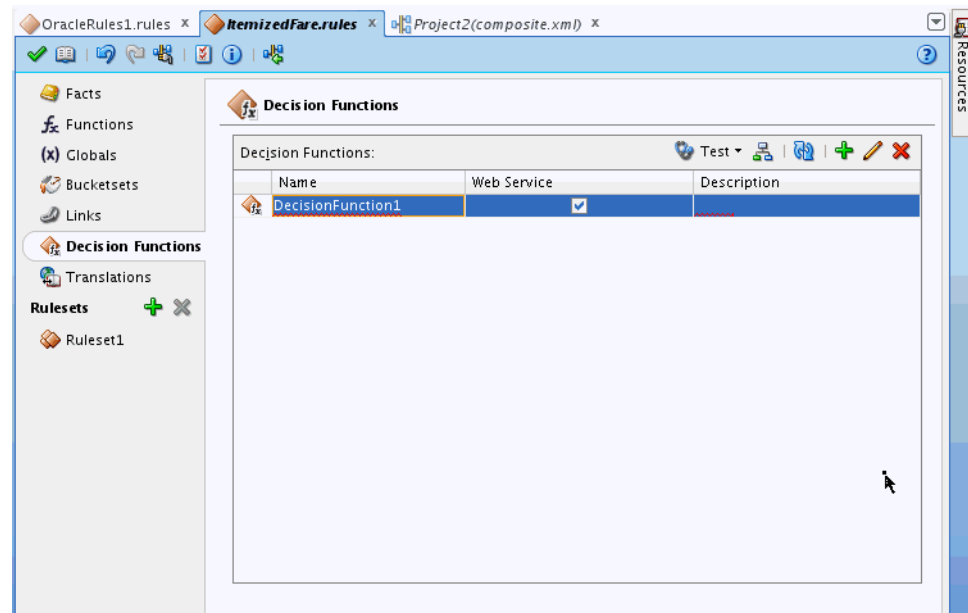
**To change the order of outputs:**

1. In Rules Designer, select the **Decision Functions** navigation tab.
2. Select the decision function to edit and click the **Edit** icon or double-click the decision function icon.
3. Select the output argument you want to move. Click either **Move Up** or **Move Down** to reorder the output argument.

To edit a Decision Function

1. Click on the Decision Function tab.  
Decision Functions are displayed as shown in [Figure 6–3](#).
2. Select the Decision Function you want to edit and click the **Edit** icon.  
Edit Decision Function dialog is displayed.
3. Make necessary changes using the process that you have used for adding a new Decision Function.

**Figure 6–3** *Editing Decision Function*



## 6.3 What You Need to Know About Decision Functions

A decision function is a function that is configured declaratively.

### 6.3.1 What You May Need to Know About Rule Firing Limit Option for Debugging Rules

The **Rule Firing Limit** allows you to set the maximum number of steps (rule firings) that are allowed at runtime. Using this option and specifying a value other than unlimited can help you debug certain rule design problems and in some cases might help prevent `java.lang.OutOfMemoryError` errors at runtime. This is can be useful when debugging infinitely recursive rule firings.

When you choose a value other than unlimited, and choose **Rule Firing Limit is Error**, system throws an error once the limit is reached.

### 6.3.2 What You May Need to Know to About Decision Function Arguments

Oracle Business Rules generates a corresponding RL Language function for each decision function.

The signature of a generated decision function is similar to:

```
function <name>(InputFactType1 input1, ... InputFactTypeN inputN) returns List
```

In a decision function, each parameter is generated depending on the **List** option, with the decision function input, as follows:

- Input argument, **List** option unselected: for `FactTypei` the input must be a single object and the assertion applies only to that single input object.
- Input **List** option selected: `List<FactTypei>` the input must be a `List` of objects and the assertion applies to each object in the input `List` (`java.util.List`).

The generated RL Language function includes calls either to `assert` or `assertTree` for each argument, depending on the decision function Input option, **Tree**. When **Tree** is unselected the input is asserted using the `assert` function. When **Tree** is selected, the input is asserted using the `assertTree` function. When **Tree** is selected it is expected that the input object or objects are the root of an object tree that is connected in one-to-many relationships with other objects using `List` or array type properties.

For the decision function selected rulesets, as specified in the **Rulesets and Decision Functions** area **Selected** box, the generated RL Language function includes a call to `run()` with the selected rulesets in the selected ruleset stack order.

The generated RL Language function returns a list. The list has an element for each decision function output in order. If the output is declared to be a list, then the corresponding element is a list. However, if the output is not declared to be a list, then the corresponding element is the output fact or null (if there is no output fact of the declared type). If an output is not declared to be a list, and more than one output fact of the specified type is found in the working memory of Oracle Business Rules Engine, then an exception is thrown.

After you edit a decision function, for example, to change or add inputs and outputs, the changes are visible in BPEL for new Business Rule activities. However, the changes are not visible to existing Business Rule activities. For more information, see "Getting Started with Oracle Business Rules" in the *Developing SOA Applications with Oracle SOA Suite*.

### 6.3.3 What You May Need to Know About the Decision Function Stateless Option

A decision function supports either stateful or stateless operation. The **Stateless** checkbox in the Edit Decision Function dialog provides support for these two modes of operation.

By default the **Stateless** checkbox is selected which indicates stateless operation. With stateless operation, at runtime, the rule session is released after each invocation of the decision function.

When **Stateless** is deselected the underlying Oracle Business Rules object is kept in the memory of the Business Rules service engine, so that it is not given back to the Rule Session Pool when the operation is finished. A subsequent use of the decision function re-uses the cached RuleSession object, with all its state information from the previous invocation. Thus, when **Stateless** is deselected the rule session is saved for a subsequent request and a sequence of decision function invocations from the same process should always end with a stateless invocation.



---

---

## Working with Rules SDK Decision Point API

This chapter describes how to use Oracle Business Rules SDK (Rules SDK) to write applications that access, create, modify, and execute rules in Oracle Business Rules dictionaries (and work with the contents of a dictionary). It also provides a brief description of Rules SDK and shows how to work with the Rules SDK Decision Point API.

The chapter includes the following sections:

- [Section 7.1, "Introduction to Rules SDK and the Car Rental Sample Application"](#)
- [Section 7.2, "Creating a Dictionary for Use with a Decision Point"](#)
- [Section 7.3, "Creating a Java Application Using Rules SDK Decision Point"](#)
- [Section 7.4, "Running the Car Rental Sample"](#)
- [Section 7.5, "What You Need to Know About Using Decision Point in a Production Environment"](#)
- [Section 7.6, "What You Need to Know About Decision Point and Decision Tracing"](#)

For more information, see *Oracle Fusion Middleware Java API Reference for Oracle Business Rules*.

### 7.1 Introduction to Rules SDK and the Car Rental Sample Application

The Rules SDK consists of four areas:

- Engine: provides for rules execution
- Storage: provides access to rule dictionaries and repositories
- Editing: provides a programmatic way to create and modify dictionary components
- Decision Point: provides an interface to access a dictionary and execute a decision function

Other than for explanation purposes, there is not an explicit distinction between these areas in Rules SDK. For example, to edit rules you also need to use the storage area of Rules SDK to access a dictionary. These parts of the Rules SDK are divided to help describe the different modes of usage, rather than to describe distinct Rules SDK APIs.

#### 7.1.1 Introduction to Decision Point API

The Decision Point API provides a concise way to execute rules. Most users create Oracle Business Rules artifacts, including data model elements, rules, Decision Tables, and rulesets using the Rules Designer extension to Oracle JDeveloper. Thus, most

users do not need to work directly with the engine, storage, or editing parts of Rules SDK.

To work with the Rules SDK Decision Point package you need to understand three important classes:

- **DecisionPoint**: is a helper class that follows the factory design pattern to create instances of `DecisionPointInstance`. In most applications there should be one `DecisionPoint` object that is shared by all application threads. A caller uses the `getInstance()` method of `DecisionPoint` to get an instance of `DecisionPointInstance` which can be used to call the defined Decision Point.
- **DecisionPointBuilder**: follows the Builder design pattern to construct a Decision Point.
- **DecisionPointInstance**: users call `invoke()` in this class to assert facts and execute a decision function.

The `DecisionPoint` classes support a fluent interface model so that methods can be chained together. For more information, see

<http://www.martinfowler.com/bliki/FluentInterface.html>

A Decision Point manages several aspects of rule execution, including:

- Use of `oracle.rules.rl.RuleSession` objects
- Reloading of a dictionary when the dictionary is updated

To create a Decision Point in a Java application you need the following:

- Either the name of a dictionary to be loaded from an MDS repository or a pre-loaded `oracle.rules.sdk2.dictionary.RuleDictionary` instance.
- The name of a decision function stored in the specified dictionary.

## 7.1.2 How to Obtain the Car Rental Sample Application

This chapter shows a car rental application that demonstrates the use of Rules SDK and the Decision Point API. You can obtain the sample application in a ZIP file, `CarRentalApplication.zip`. This ZIP contains a complete JDeveloper application and project.

The source code for Oracle Business Rules-specific samples and SOA samples are available online in the Oracle SOA Suite samples page.

To work with the sample unzip `CarRentalApplication.zip` into an appropriate directory. The car rental application project contains a rules dictionary and several Java examples using Rules SDK.

## 7.1.3 How to Open the Car Rental Sample Application and Project

The Car Rental sample application shows you how to work with the Rules SDK Decision Point API.

### To open the car rental sample application:

1. Start Oracle JDeveloper.
2. Open the car rental application in the directory where you unzipped the sample. For example, from the File menu select **Open...** and in the Open dialog navigate to the `CarRentalApplication` folder.
3. In the Open dialog select `CarRentalApplication.jws` and click **Open**.



4. In the Application Navigator, expand the **CarRentalApplication**, expand **Application Sources** and **Resources**. This displays the Oracle Business Rules dictionary named `CarRental.rules` and several Java source files.

## 7.2 Creating a Dictionary for Use with a Decision Point

The car rental sample uses the Rules SDK Decision Point API with either a pre-loaded Oracle Business Rules dictionary or a repository stored in MDS. When you are working in a development environment you can use the Decision Point API with the pre-loaded dictionary signature. In a production environment you would typically use a Decision Point with the MDS repository signature.

The CarRental dictionary is pre-defined and is available in the car rental sample application.

To work with the Decision Point API you need to create a dictionary that contains a decision function (the car rental sample application comes with a predefined dictionary and decision function).

You perform the following steps to create a dictionary and a decision function:

- [Section 7.2.1, "How to Create Data Model Elements for Use with a Decision Point"](#)
- [Section 7.2.2, "How to View a Decision Function to Call from the Decision Point"](#)
- [Section 7.2.3, "How to Create Rules or Decision Tables for the Decision Function"](#)

### 7.2.1 How to Create Data Model Elements for Use with a Decision Point

You need the following to add to a decision function when you create an application with a Decision Point.

- A dictionary containing data model elements that you use to create rules or Decision Tables and when working with ADF Business Components fact types, you need to add links for the Decision Point support dictionary. For more information, see [Chapter 2, "Working with Data Model Elements"](#). For more information, see [Chapter 10, "Working with Oracle Business Rules and ADF Business Components"](#).
- A dictionary containing fact definitions. For more information, see [Chapter 3, "Working with Facts and Bucketsets"](#).

#### To view the data model in the supplied car rental sample application:

1. In Rules Designer, click the **Facts** navigation tab.
2. Select the **Java Facts** tab, as shown in [Figure 7-1](#).

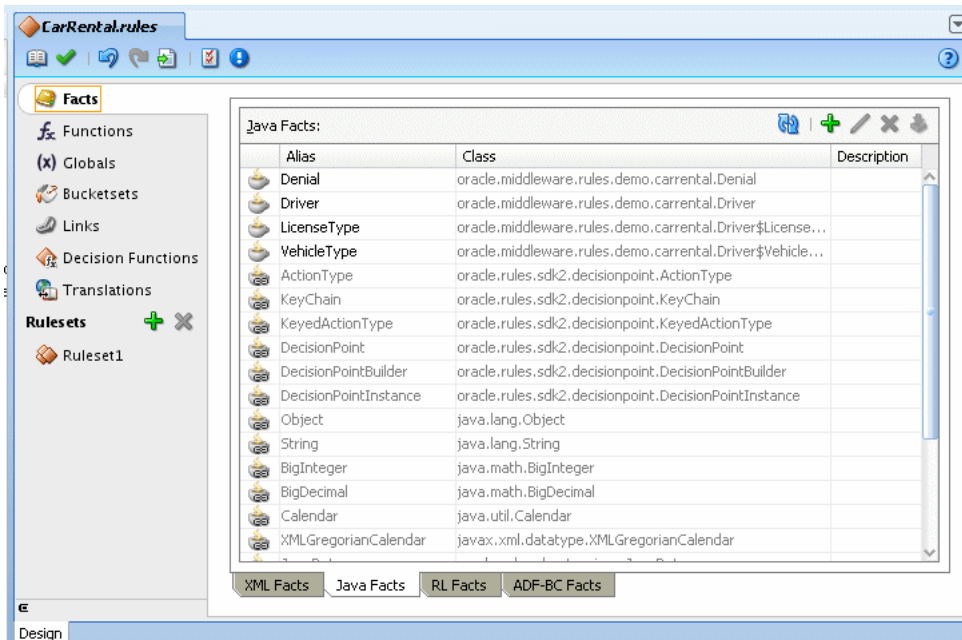
The **Java Facts** tab shows four fact types imported, in addition to the fact types provided as built-in to the dictionary.

The Driver Java Fact is imported from the Driver Java class in the project.

The Denial Java Fact is imported from Denial Java class in the project.

The LicenseType and VehicleType facts are imported from the nested enum classes defined in the Driver class.

**Figure 7–1 Defined Java Facts for the Car Rental Sample Application**



When you use a Decision Point with Rules SDK, you call a decision function in a specified dictionary. The decision function that you call can contain one or more rulesets that are executed as part of the Decision Point.

**To view the ruleset in the supplied car rental sample application:**

1. In Rules Designer, expand the **CarRentalApplication**.
2. In the CarRentalApplication, expand **Resources**.
3. Double-click the **CarRental.rules**.

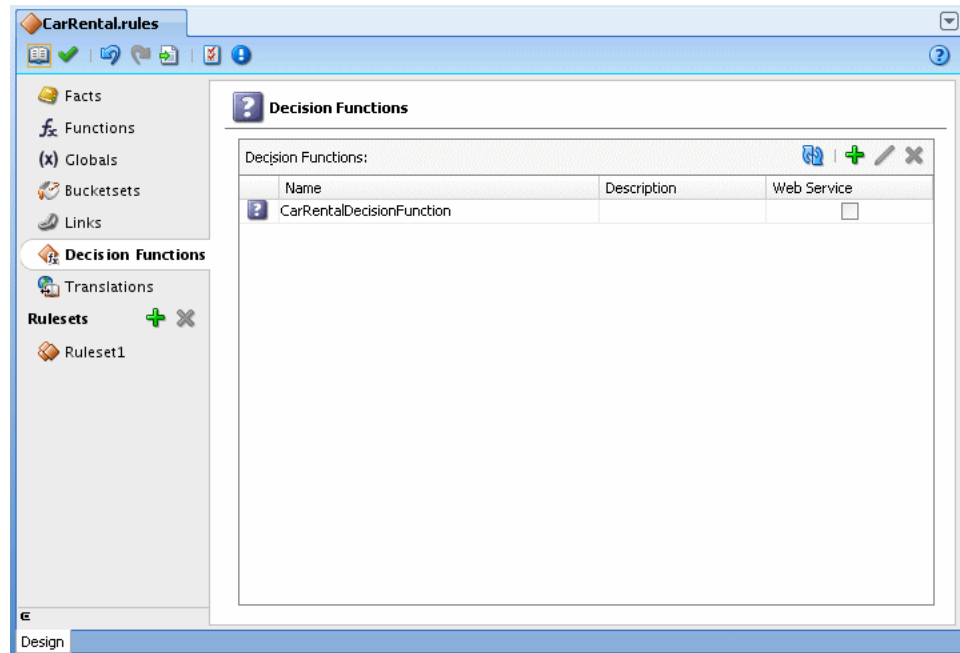
**7.2.2 How to View a Decision Function to Call from the Decision Point**

When you work with the Decision Point API you use decision functions to expose an Oracle Business Rules dictionary. For more information on decision functions, see [Chapter 6, "Working with Decision Functions"](#).

**To view the decision function in the car rental sample application:**

1. In Rules Designer, click the **Decision Functions** navigation tab. This displays the available decision functions in the CarRental dictionary, as shown in [Figure 7–2](#).

Figure 7-2 Car Rental Sample Decision Function



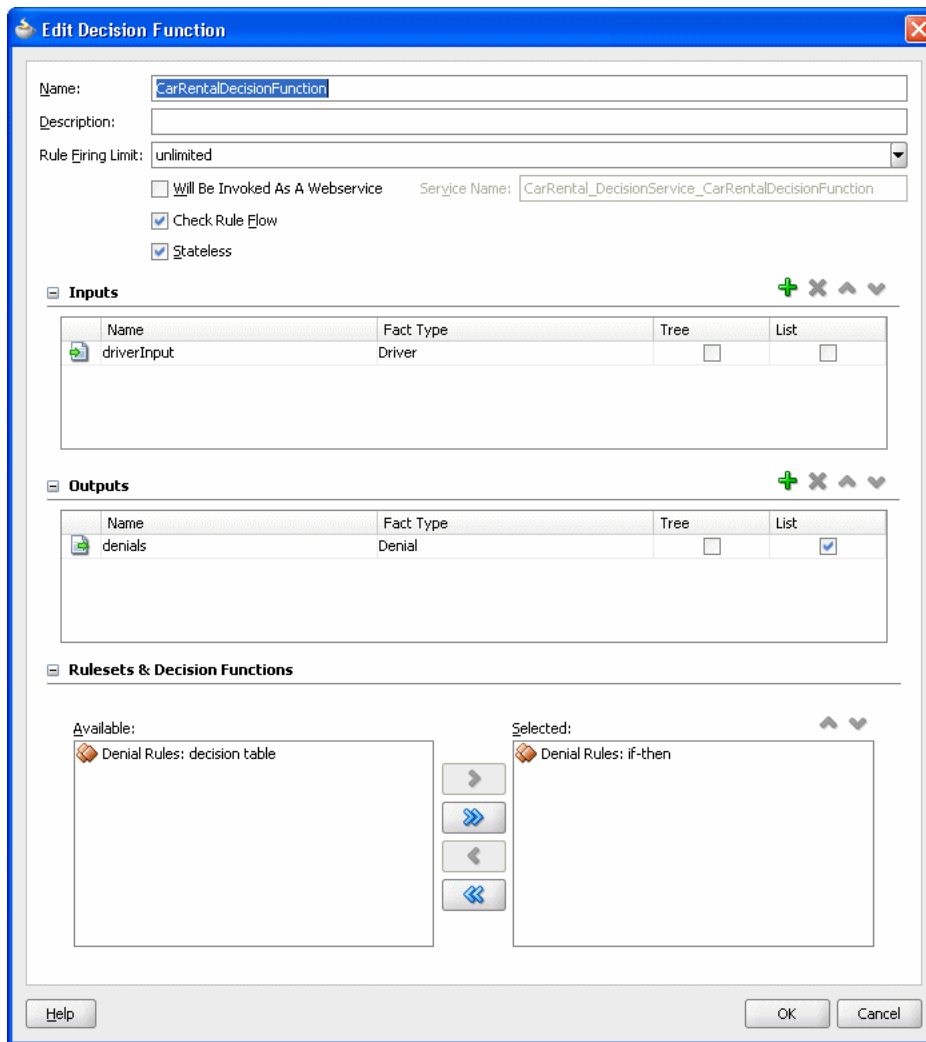
2. Select the row with CarRentalDecisionFunction and double-click the decision function icon. This opens the Edit Decision Function dialog as shown in Figure 7-3.

The decision function **Inputs** table includes a single argument for a Driver fact type.

The decision function **Outputs** table includes a single argument for a Denial fact type.

The decision function **Rulesets and Decision Functions** area shows **Denial Rules:if-then** in the **Selected** box.

**Figure 7-3 Car Rental Decision Function for the Car Rental Sample Application**



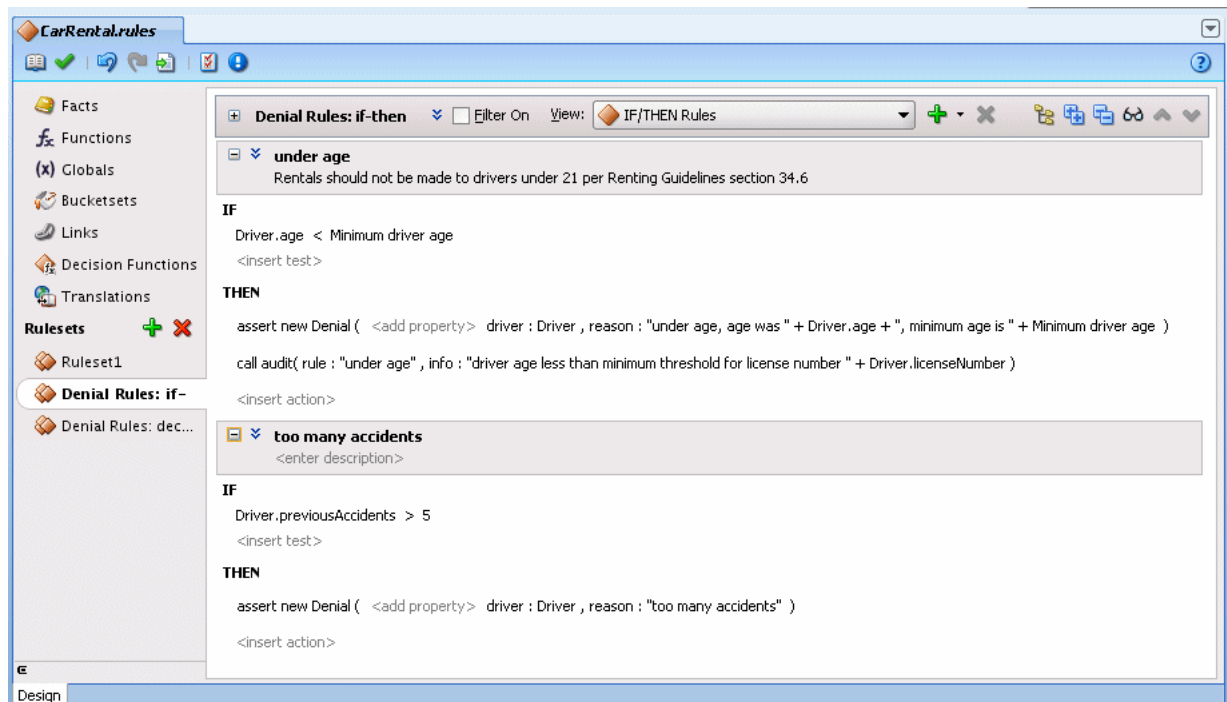
### 7.2.3 How to Create Rules or Decision Tables for the Decision Function

The car rental sample includes two rulesets, one with IF/THEN rules and another containing a Decision Table. You can use either IF/THEN rules or Decision Tables or both in your application if you are using a Decision Point.

**To view the rules in the car rental sample application:**

1. In Rules Designer click the **Denial Rules:if-then** ruleset, as shown in [Figure 7-4](#).

Figure 7-4 Ruleset with IF/THEN Rules for the Car Rental Sample Application



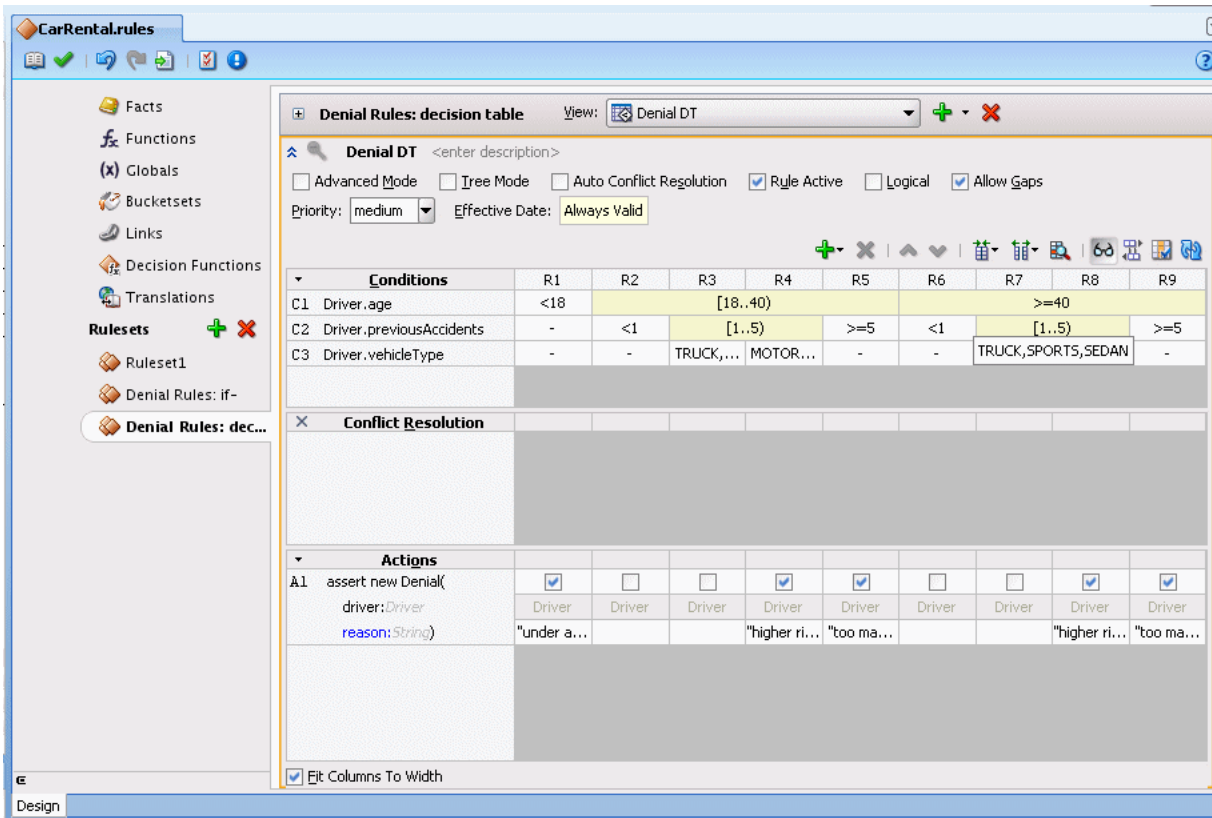
The **Denial Rules:if-then** ruleset includes two rules:

- **under age:** this rule defines the minimum age of the driver. The rule compares the Driver instance age property to the global Minimum driver age. If the driver is under this age, then a new Denial fact is asserted. A call to the decision function collects this Denial fact, as defined in its output. The rule also calls a user-defined function, audit, to provide some auditing output about why the Denial is created.
- **too many accidents:** this rule defines an upper threshold for the number of accidents a driver can have before a rental for the driver is denied. The rule also calls a user-defined function, audit, to provide some auditing output about why the Denial is created.

**To view the Decision Table in the car rental application:**

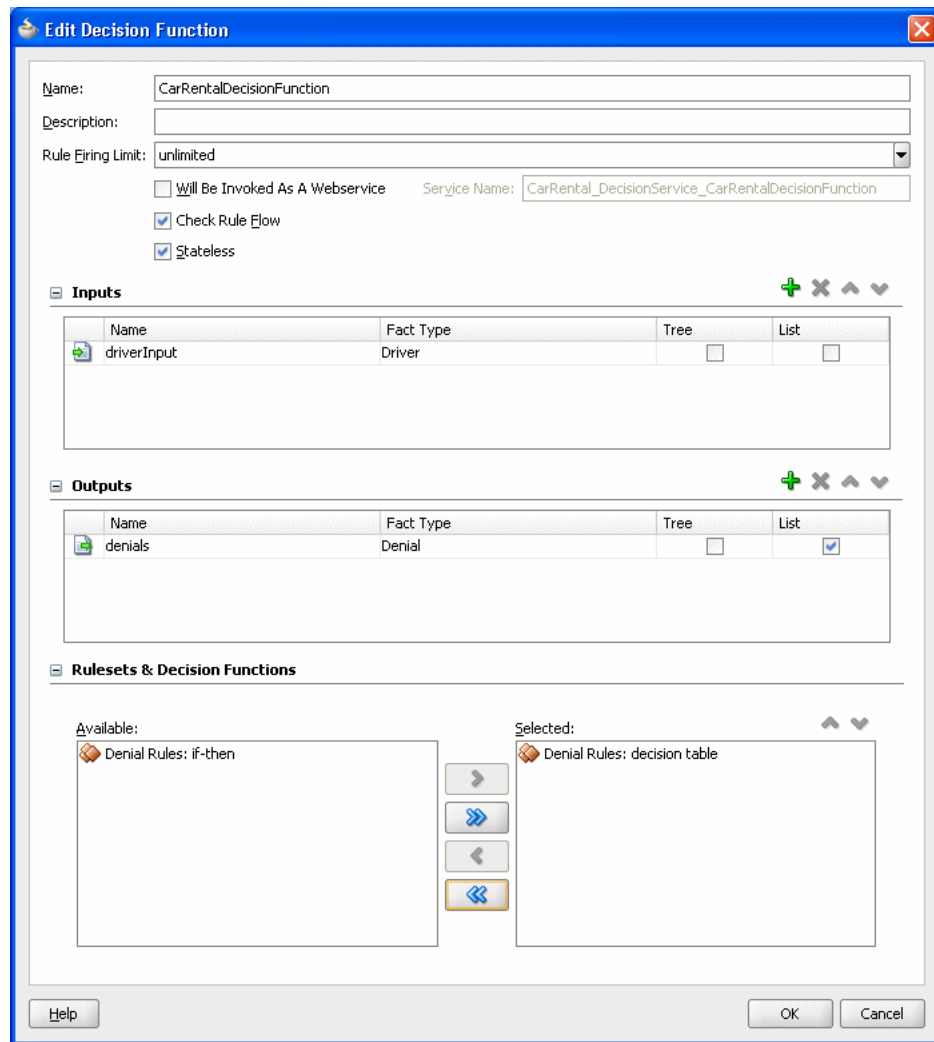
1. In Rules Designer, click the **Denial Rules:decision table** ruleset, as shown in [Figure 7-5](#).

Figure 7-5 Ruleset with Decision Table for the Car Rental Sample Application



## 7.2.4 What You Need to Know About Using Car Rental Sample with a Decision Table

The car rental sample application includes the **Denial Rules: decision table** ruleset. To switch to use a Decision Table in the supplied decision function sample, move the **Denial Rules:if-then** from the **Selected** area in the decision function and add the **Denial Rules: decision table** ruleset, which uses a Decision Table to define similar rules, as shown in [Figure 7-6](#).

**Figure 7–6 Decision Function for Car Rental Sample with Decision Table Ruleset**

### 7.3 Creating a Java Application Using Rules SDK Decision Point

When use Rules SDK in a development environment you of the option of using Decision Point API with a pre-loaded dictionary. In a production environment you typically use the Decision Point API with the MDS repository signature and the dictionary is stored in MDS. For more information on using a Decision Point with, see [Section 7.5, "What You Need to Know About Using Decision Point in a Production Environment"](#).

The source code for Oracle Business Rules-specific samples and SOA samples are available online in the [Oracle SOA Suite samples page](#).

The CarRentalProject project includes the `com.example.rules.demo` package that includes the car rental sample file, `CarRentalWithDecisionPointUsingPreloadedDictionary.java`. The project also includes several `.java` source files that support different variations for using Decision Point. [Table 7–1](#) provides a summary of the different versions of the car rental sample.

For more information on working with the Rules SDK Decision Point API, see *Oracle Fusion Middleware Java API Reference for Oracle Business Rules*.

**Table 7–1 Java Files in the Decision Point Sample CarRentalProject**

Base Java Filename	Description
CarRental	This is the base class for all of the examples. It contains constant values for using the CarRental dictionary and a method <code>createDrivers</code> which creates instances of the <code>Driver</code> class.
CarRentalWithDecisionPoint	Contains a static attribute of type <code>DecisionPoint</code> and a method <code>checkDriver()</code> that invokes a <code>Decision Point</code> with a specified instance of the <code>Driver</code> class. This class includes these methods for the sample application so that both the MDS repository and pre-loaded dictionary examples can share the same <code>checkDriver()</code> implementation.
CarRentalWithDecisionPointUsingMdsRepository	Contains an example of creating a <code>Decision Point</code> that uses MDS to access and load the rule dictionary. In a production environment, most applications use the <code>Decision Point</code> API with MDS.
CarRentalWithDecisionPointUsingPreloadedDictionary	Contains an example of creating a <code>Decision Point</code> from an instance of the <code>RuleDictionary</code> class. This example also contains code for manually loading the dictionary to create a <code>RuleDictionary</code> instance.
CarRentalWithRuleSession	Contains an advanced usage of the <code>Engine</code> API that is documented further in the comments.
CarRentalWithRuleSessionPool	Contains an advanced usage of the <code>Engine</code> API that is documented further in the comments.
Denial	Contains the class that defines the <code>Denial</code> fact type used to create the rules and <code>Decision Table</code> .
Driver	Contains the class that defines the <code>Driver</code> fact type used to create the rules and <code>Decision Table</code> .
DriverCheckerRunnable	Contains the class which can be used as a thread for simulating concurrent users invoking the <code>Decision Point</code> .

### 7.3.1 How to Add a Decision Point Using Decision Point Builder

To use a `Decision Point` you create a `DecisionPoint` instance using `DecisionPointBuilder`, as shown in [Example 7–1](#).

**Example 7–1 Using the Decision Point Builder**

```

static {
    try {
        // specifying the Decision Function and a pre-loaded
        // RuleDictionary instance
        m_decisionPoint = new DecisionPointBuilder()
            .with(DF_NAME)
            .with(loadRuleDictionary())
            .build();
    } catch (SDKException e) {
        System.err.println("Failed to build Decision Point: " +
            e.getMessage());
        e.printStackTrace();
    }
}

```

[Example 7–1](#) shows the `DecisionPointBuilder` supports a fluent interface pattern, so all methods can easily be chained together when you create a `Decision Point`. The three most common methods for configuring the `Decision Point` with `DecisionPointBuilder` are overloaded to have the name `with()`. Each `with()` method takes a single argument of type `RuleDictionary`, `DictionaryFQN`, or `String`. The `DecisionPointBuilder` also supports similar `set` and `get` methods:



```
getDecisionFunction(), setDecisionFunction(), getDictionary(),
setDictionary(), getDictionaryFQN(), setDictionaryFQN().
```

This chain shown in [Example 7-1](#) includes the following steps:

1. The first step is to create a `DecisionPointBuilder` instance with code such as the following:

```
new DecisionPointBuilder()
```

2. The `with()` method using a `String` argument defines the name of the decision function that the Decision Point executes. Calling this method is mandatory.

```
.with(DF_NAME)
```

The `DF_NAME` specifies the name of the decision function you define for your application. For example for the sample car rental application `DF_NAME` is defined in `CarRental.java` as `CarRentalDecisionFunction`.

3. Call only one of the other two `with()` methods. In this case the sample code uses a pre-loaded Rule Dictionary instance, containing the specified decision function. The `loadDictionary()` method loads an instance of `RuleDictionary` from a file. [Example 7-2](#) shows the `loadDictionary()` method. For more information, see [Section 7.3.2, "How to Use a Decision Point with a Pre-loaded Dictionary"](#).

```
.with(loadRuleDictionary())
```

4. Call the `build()` method to construct and return a `DecisionPoint` instance.

The `DecisionPoint` instance is shared among all instances of the application, which is why it is a static attribute and created in a static block. Another way of initializing the `DecisionPoint` would be to initialize the `m_decisionPoint` attribute with a static method that created and returned a `DecisionPoint` instance.

## 7.3.2 How to Use a Decision Point with a Pre-loaded Dictionary

[Example 7-2](#) shows the `loadRuleDictionary()` method that loads an instance of `RuleDictionary` from a file.

When reading or writing a dictionary directly from a file as shown in [Example 7-2](#), ensure to set the encoding to UTF-8. If this is not done, Unicode characters used in the dictionary are corrupted. The UTF-8 option must be set explicitly in the `FileInputStream` or `OutputStreamWriter` constructor. Do not use Java classes such as `FileReader` and `FileWriter`, as these classes always use the platform default encoding which is usually an ASCII variant rather than a Unicode variant.

### **Example 7-2 Load Rule Dictionary Method**

```
private static RuleDictionary loadRuleDictionary(){
    RuleDictionary dict = null;
    BufferedReader reader = null;
    try {
        reader = new BufferedReader(
            new InputStreamReader(
                new FileInputStream(
                    new File(DICT_LOCATION)), "UTF-8"));
        dict = RuleDictionary.readDictionary(reader,
            new
DecisionPointDictionaryFinder(null));

        List<SDKWarning> warnings = new ArrayList<SDKWarning>();
```

```

        dict.update(warnings);
        if (warnings.size() > 0) {
            System.err.println("Validation warnings: " + warnings);
        }
    } catch (SDKException e) {
        System.err.println(e);
    } catch (FileNotFoundException e) {
        System.err.println(e);
    } catch (IOException e) {
        System.err.println(e);
    } finally {
        if (reader != null) { try { reader.close(); } catch (IOException
ioe) {ioe.printStackTrace();}}
    }
    return dict;
}

```

### 7.3.3 How to Use Executor Service to Run Threads with Decision Point

The car rental sample allows you to use Oracle Business Rules and simulate multiple concurrent users. [Example 7-3](#) shows use of the Java `ExecutorService` interface to execute multiple threads that invoke the Decision Point. The `ExecutorService` is not part of the Rules SDK Decision Point API.

#### **Example 7-3** *Checking Drivers with Threads that Invoke Decision Point*

```

ExecutorService exec = Executors.newCachedThreadPool();
List<Driver> drivers = createDrivers();

for (int i = 0; i < NUM_CONCURRENT; i++) {
    Driver driver = drivers.get(i % drivers.size());
    exec.execute(new DriverCheckerRunnable(driver));
}

```

[Example 7-3](#) includes the following code for the sample application:

- Create the Executor Service:

```
ExecutorService exec = Executors.newCachedThreadPool();
```

- Call method `createDrivers()`, defined in `CarRental.java`, to create a list of `Driver` instances.

```
List<Driver> drivers = createDrivers();
```

- A loop through a list of `Driver` instances to fill the driver list with drivers.
- A loop to start multiple threads from `DriverCheckerRunnable` instances. These instances open a Decision Point and run the rules on each driver. For information on this code, see [Section 7.3.4, "How to Create and Use Decision Point Instances"](#).

[Example 7-4](#) shows the code that waits for the threads to complete.

#### **Example 7-4** *Code to Await Thread Termination*

```

try {
    exec.awaitTermination(5, TimeUnit.SECONDS);
} catch (InterruptedException e) {
    e.printStackTrace();
}

```

```

    }
    exec.shutdown();
}

```

### 7.3.4 How to Create and Use Decision Point Instances

The `DriverCheckerRunnable` instances call the `checkDriver()` method. [Example 7-5](#) shows the `checkDriver()` method that is defined in `CarRentalWithDecisionPoint`. The `checkDriver()` method handles invoking Decision Point with a `Driver` instance.

#### **Example 7-5 Code to Create a Decision Point Instance with `getInstance()`**

```

public class CarRentalWithDecisionPoint extends CarRental {

    protected static DecisionPoint m_decisionPoint;

    public static void checkDriver(final Driver driver) {
        try {
            DecisionPointInstance instance = m_decisionPoint.getInstance();
            instance.setInputs(new ArrayList<Object>() {
                {
                    add(driver);
                }
            });
            List<Object> outputs = instance.invoke();

            if (outputs.isEmpty())
                System.err.println("Oops, no results");

            java.util.List<Denial> denials =
                (java.util.List<Denial>)outputs.get(0);
            if (denials.isEmpty()) {
                System.out.println("Rental is allowed for " +
                    driver.getName());
            } else {
                for (Denial denial : denials) {
                    System.out.println("Rental is denied for " +
                        denial.getDriver().getName() +
                        " because " + denial.getReason());
                }
            }
        } catch (RLEException e) {
            e.printStackTrace();
        } catch (SDKException e) {
            e.printStackTrace();
        }
    }
}

```

[Example 7-5](#) shows the following:

- Getting a `DecisionPointInstance` from the static `DecisionPoint` defined with the `DecisionPointBuilder`, with the following code.

```
DecisionPointInstance instance = m_decisionPoint.getInstance();
```

- Add inputs according to the signature of the decision function associated with the Decision Point. This defines one argument of type `List` as the input. This `List` contains the `Driver` instances:

```
instance.setInput(new ArrayList<Object>() {
    {
        add(driver);
    }
});
```

- Invoke the Decision Point and store the return value. The return type follows the same pattern as the decision function which is being called in the Decision Point.

```
List<Object> outputs = instance.invoke();
```

In this case the `invoke()` returns a `List` of length one, containing a `List` of `Denial` instances.

- If the return is a `List` of any other size than one, then this is an error:

```
if (outputs.isEmpty())
    System.err.println("Oops, no results");
```

- The first entry that is returned from the Decision Point is cast it to a `List` of type `List<Denial>`:

```
java.util.List<Denial> denials =
    (java.util.List<Denial>)outputs.get(0);
```

- If the denials list is empty, then no `Denial` instances were asserted by the rules. This indicates that it is OK to rent a car to the driver. Otherwise, print the reasons why the driver rental was rejected:

```
if (denials.isEmpty()) {
    System.out.println("Rental is allowed for " +
        driver.getName());
} else {
    for (Denial denial : denials) {
        System.out.println("Rental is denied for " +
            denial.getDriver().getName() +
            " because " + denial.getReason());
    }
}
```

## 7.4 Running the Car Rental Sample

In the car rental sample installed on your system, for the code shown in [Example 7-2](#), modify the value of `DICT_LOCATION` to match the location of the dictionary on your system.

### To run the car rental sample on your system:

1. In the Application Navigator, select the dictionary and from the **Edit** menu select **Copy Path**.
2. In the `CarRental.java` file, paste the path value into the `DICT_LOCATION` value.
3. In the **CarRentalProject** select the **CarRentalWithDecisionPointUsingPreloadedDictionary.java** file.
4. Right-click and in the list select **Run**.

[Example 7-6](#) shows sample output.

**Example 7-6 Output from Car Rental Sample**

```
Rental is allowed for Carol
Rental is allowed for Alice
Rental is allowed for Alice
Rental is allowed for Carol
Rental is denied for Bob because under age, age was 15, minimum age is 21
Mar 13, 2009 11:18:00 AM oracle.rules.rl.exceptions.LogWriter flush
INFO: Fired: under age because driver age less than minimum threshold for license
number d222
Mar 13, 2009 11:18:00 AM oracle.rules.rl.exceptions.LogWriter flush
INFO: Fired: under age because driver age less than minimum threshold for license
number d222
Rental is denied for Bob because under age, age was 15, minimum age is 21
Rental is allowed for Alice
Rental is allowed for Eve
```

## 7.5 What You Need to Know About Using Decision Point in a Production Environment

In a production environment you can use an MDS repository to store Oracle Business Rules dictionaries. When you use an MDS repository to store the dictionary, the steps shown in [Section 7.3.1, "How to Add a Decision Point Using Decision Point Builder"](#) and [Section 7.3.2, "How to Use a Decision Point with a Pre-loaded Dictionary"](#) change to access the dictionary. The `CarRentalWithDecisionPointUsingMdsRepository` shows sample code for using Decision Point with MDS.

To see a complete example with deployment steps showing the use of a Decision Point to access a dictionary in MDS, see [Section 9.4, "Adding a Servlet with Rules SDK Calls for Grades Sample Application"](#).

[Example 7-7](#) shows the use of `DictionaryFQN` with `DecisionPointBuilder` to access a dictionary in an MDS repository. The complete example is shown in the sample code in `CarRentalWithDecisionPointUsingMdsRepository`.

**Example 7-7 Using Decision Point Builder with MDS Repository**

```
static {
    try {
        // specifying the Decision Function and Dictionary FQN
        // loads the rules from the MDS repository.
        m_decisionPoint = new DecisionPointBuilder()
            .with(DF_NAME)
            .with(DICT_FQN)
            .build();
    } catch (SDKException e) {
        System.err.println("Failed to build Decision Point: " +
            e.getMessage());
    }
}
```

Similar to the steps in [Example 7-1](#), [Example 7-7](#) shows the following:

1. The first step is to create a `DecisionPointBuilder` instance with.
 

```
new DecisionPointBuilder()
```
2. The `with()` method using a `String` argument defines the name of the decision function that the Decision Point executes. Calling this method is mandatory.

```
.with(DF_NAME)
```

The `DF_NAME` specifies the name of the decision function you define for your application. For example for the car rental application this is defined in `CarRental.java` a `CarRentalDecisionFunction`.

3. Call only one of the other two `with()` methods. In this case the sample code calls a `DictionaryFQN` to access an MDS repository. [Example 7-8](#) shows the routing that uses the dictionary package and the dictionary name to create the `DictionaryFQN`.

```
.with(DICT_FQN)
```

4. Call the `build()` method to construct and return a `DecisionPoint` instance.

**Example 7-8 Using the DictionaryFQN Method with MDS Repository**

```
protected static final String DICT_PKG = "com.example.rules.demo";
protected static final String DICT_NAME = "CarRental";

protected static final DictionaryFQN DICT_FQN =
    new DictionaryFQN(DICT_PKG, DICT_NAME);
protected static final String DF_NAME = "CarRentalDecisionFunction";
```

## 7.6 What You Need to Know About Decision Point and Decision Tracing

The Rules SDK API contains methods to assist with processing a decision trace. These methods process a decision trace to replace the RL names used in the trace with the aliases used in the associated dictionary. This makes the decision trace naming consistent with the naming used in the Oracle Business Rules dictionary.

The basic API for processing a decision trace requires a `RuleDictionary` object and a `DecisionTrace` object:

```
RuleDictionary dict = ...;
DecisionTrace trace = ...;
dict.processDecisionTrace(trace);
```

This code shows the processing call that converts the naming in the decision trace to use the same names, with aliases, as in the dictionary.

The Rules SDK Decision Point API contains methods that allow you configure decision tracing and retrieve the resulting trace when you invoke a decision point. The trace you retrieve from the Decision Point is internally processed using the `processDecisionTrace()` method, thus you do not need to call this method to process the decision trace when you are working with a decision trace from a Decision Point.

[Table 7-2](#) shows the Decision Point API methods for setting decision trace options. For more information on these methods, see *Rules Language Reference for Oracle Business Process Management*.

**Table 7-2 Decision Point Decision Tracing Methods**

Method	Description
<code>decisionTrace</code>	Get the decision trace produced from the call to invoke. Returns <code>DecisionTrace</code>

**Table 7–2 (Cont.) Decision Point Decision Tracing Methods**

Method	Description
<code>getDecisionTraceLevel</code>	Get the decision trace level to be used by the RuleSession. This value defaults to <code>DECISION_TRACE_OFF</code> , which means no trace information is gathered. Possible values are: <code>DECISION_TRACE_OFF</code> <code>DECISION_TRACE_DEVELOPMENT</code> <code>DECISION_TRACE_PRODUCTION</code> Return Type: String
<code>getDecisionTraceLimit</code>	Get the decision trace limit, or maximum number of trace elements which are retrieved for the trace. Return Type: int
<code>setDecisionTraceLevel</code>	Set the decision trace level to be used by the RuleSession. This parameter value is a String. Possible values are: <code>DECISION_TRACE_OFF</code> <code>DECISION_TRACE_DEVELOPMENT</code> <code>DECISION_TRACE_PRODUCTION</code>
<code>setDecisionTraceLimit</code>	Set the decision trace limit, or maximum number of trace elements which are retrieved for the trace.

[Example 7–9](#) shows a sample usage of decision tracing with DecisionPoint API.

**Example 7–9 Using Decision Trace from Decision Point API**

```
DecisionPoint dp = new DecisionPointBuilder()
    .with(new DictionaryFQN("com.foo", "Bar"))
    .with("MyDecisionFunction")
    .setDecisionTraceLevel(DecisionPointBuilder.DECISION_TRACE_DEVELOPMENT)
    .setDecisionTraceLimit(24000)
    .build();

...

DecisionPointInstance dpi = dp.getInstance();

dpi.invoke();

DecisionTrace trace = dpi.decisionTrace(); // with aliases replaced
```

For more information on decision tracing, see "Tracing Rule Execution in Fusion Middleware Control Console" in *Administering Oracle SOA Suite and Oracle Business Process Management Suite*.





---

---

# Testing Business Rules

This chapter describes how to test rules from Rules Designer of Oracle JDeveloper by using the Rules Test Framework provided by Oracle Business Rules. It also discusses how to test rules and Decision Tables by creating an Oracle Business Rules Function. In addition, it covers at runtime, how to test a SOA Application that uses Oracle Business Rules through a decision service by using Oracle Enterprise Manager Fusion Middleware Control Console.

The chapter includes the following sections:

- [Section 8.1, "Testing Oracle Business Rules at Design Time"](#)
- [Section 8.2, "Testing Oracle Business Rules at Runtime"](#)

## 8.1 Testing Oracle Business Rules at Design Time

Oracle Business Rules provides a test framework that allows you to test rules with complex input parameters. This framework enables you to test rules at the time of designing so that you can validate or refine the rules as per your requirement.

Another way of testing rules is by defining a test function, where you can construct the input, execute rules, and validate the output. Because inputs are constructed and outputs are validated programmatically, test functions are typically used for simple tests, and the test framework is used for comprehensive tests. In addition, this test function is active only for functions that do not take any parameters and only return boolean values.

### 8.1.1 How to Test Rules Using the Rules Test Framework

Oracle Business Rules provides an 'out-of-the-box' functionality that enables you to test whether the rules you are defining works fine with a given set of inputs at the time of designing. The granularity of testing provided is at the level of decision functions. When you define decision functions in a dictionary, you can define test suites and execute those test suites for each of the decision functions.

Oracle Business Rules supports multiple types of facts, such as Java facts, XML facts, RL facts, and ADFBC facts. The test framework currently only supports XML facts. So, if the decision function, which you have defined, have inputs or outputs referring to non-XML facts, the test framework cannot be used to test the decision function. If you use non-XML facts, a warning or error message is displayed indicating that you cannot use the test feature for that decision function.

#### 8.1.1.1 Creating a Decision Function

To test rules, you need to create a decision function as the prerequisite.

1. Open Oracle JDeveloper.
2. From the Application Navigator, open the project file containing the dictionary whose rules you want to test, say `BaseDictionary.rules` under Business Rules.
3. In the dictionary section, click **Decision Functions** to open the list of decision functions.
4. In the decision functions section, click the Create icon (the plus sign) to display the Edit Decision Function dialog box.
5. Enter the name of the decision function in the **Name** field, say `TestDF`.
6. In the **Input** tab, enter the input name under **Name** and press Enter. In this example, enter `songs`.
7. Select the fact type from the Fact Type list. Ensure that you select XML facts. In this example, select **Song** as the fact type. Similarly, another input variable with the name as `artists` and fact type as **Artist** has been added.
8. Select **Tree** or **List** as required. See [Section 6.2.1, "How to Add or Edit a Decision Function"](#) for more information on tree or list mode rules.
9. In the **Output** tab, enter an output name under Name and press Enter. In this example, enter `songs`.
10. Select the fact type from the Fact Type list. Ensure that you select XML facts. In this example, select **Song**.
11. Under Rulesets & Decision Functions, select the ruleset that you want to invoke from the **Available** box, and use the shutter (>) icon to move it to the **Selected** box. In this example, **SongArtistRules** has been selected.

---

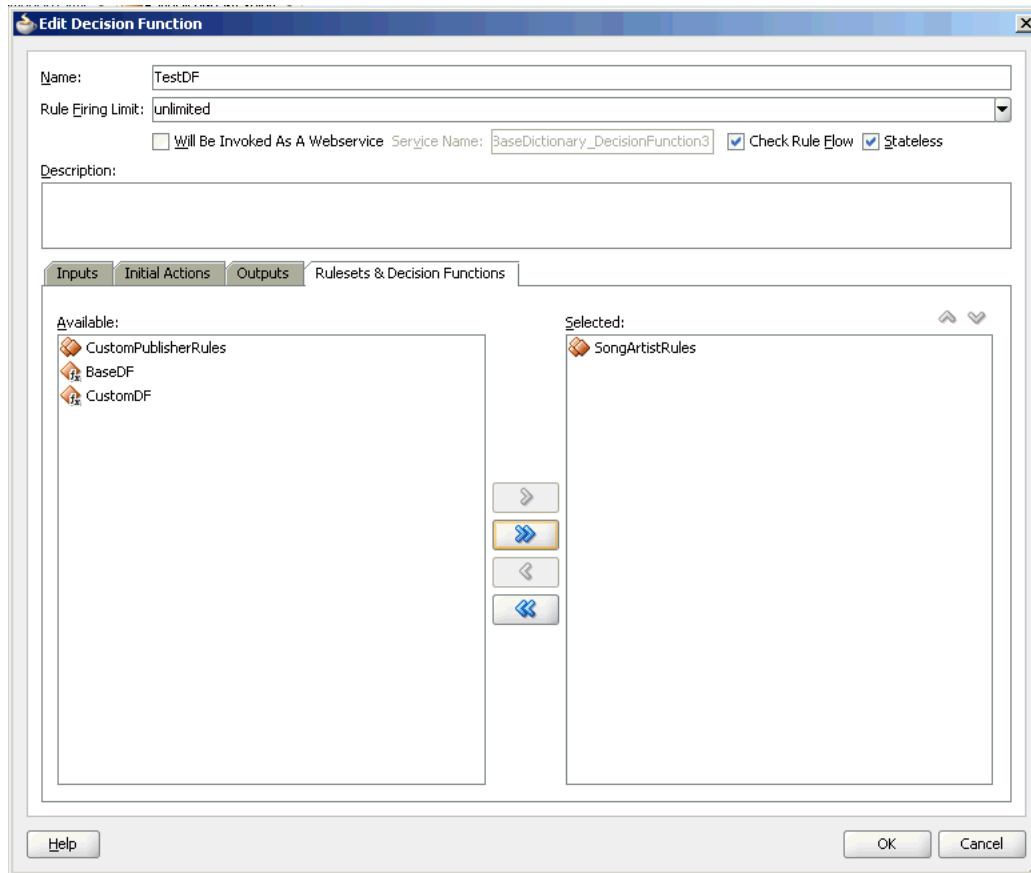
---

**Note:** This example uses sample schema and corresponding facts.

---

---

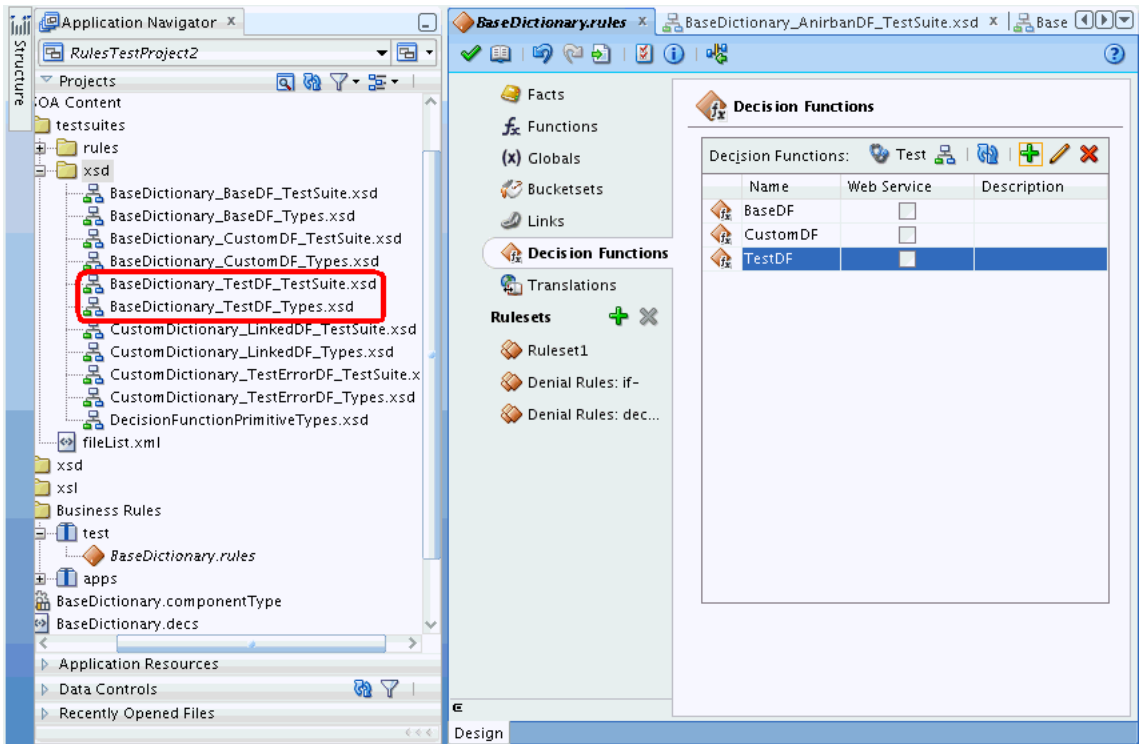
12. Click **OK** to create the decision function. [Figure 8-1](#) displays the Edit Decision Function dialog box.

**Figure 8–1 The Edit Decision Function Dialog**

When you create a decision function, two XML schemas (xsd files) get automatically generated to help in testing the decision function. These schemas have suffixes `_TestSuite` and `_Types` respectively. Further, these schemas are stored in an `xsd` folder under the `testsuites` folder, which can be seen in the Application Navigator as shown in [Figure 8–2](#).

You need to define the test suites, which are created for the decision function, based on the schema with the suffix `_TestSuite`.

Figure 8–2 Application Navigator Displaying XSDs



The generated schema files follows the following naming convention:

- <DictionaryName>\_<DecisionFunctionName>\_TestSuite.xsd**: This file contains the test suite schema for the decision function. Test Suites created for this decision function should conform to this schema. The following is a sample of the TestSuite.xsd file:

```
<?xml version = '1.0' encoding = 'UTF-8'?>
<schema xmlns="http://www.w3.org/2001/XMLSchema"
xmlns:tns="http://xmlns.oracle.com/rules/test"
targetNamespace="http://xmlns.oracle.com/rules/test"
elementFormDefault="qualified" attributeFormDefault="unqualified"
xmlns:df="http://xmlns.oracle.com/rules/BaseDictionary/BaseDF">
  <annotation>
    <documentation>
      Decision Function Test Suite Schema
    </documentation>
  </annotation>
  <import namespace="http://xmlns.oracle.com/rules/BaseDictionary/BaseDF"
  schemaLocation="BaseDictionary_BaseDF.Types.xsd"/>
  <element name="testSuite">
    <complexType>
      <sequence>
        <element name="decisionFunction" type="string" minOccurs="1"
        maxOccurs="1"/>
        <element name="testCase" type="tns:testCaseType" minOccurs="1"
        maxOccurs="unbounded"/>
      </sequence>
    </complexType>
  </element>

  <complexType name="testCaseType">
    <sequence>
```

```

        <element name="testInput" type="df:parameterList" minOccurs="0"
            maxOccurs="1"/>
        <element name="expectedOutput" type="df:resultList" minOccurs="0"
            maxOccurs="1"/>
    </sequence>
    <attribute name="name" type="string" use="required"/>
</complexType>
</schema>

```

As you can see in the preceding sample, the schema contains a master `testSuite` element, which in turn contains an element called `decisionFunction` that defines to which decision function does this test suite corresponds. The `testSuite` element also contains one or more `testCase` elements. Each `testCase` contains a `testInput` and `expectedOutput` elements and a `name`. The `testInput` values are the ones that are used as inputs to the test cases and `expectedOutput` values are the ones against which the actual outputs are matched. The types of `testInput` and `expectedOutput` (`parameterList` and `resultList` respectively) have been defined in the subsequent XSD.

- `<DictionaryName>_<DecisionFunctionName>_Types.xsd`: This schema contains two `complexType` elements, `parameterList` and `resultList`. These two types are used in the `TestSuite` schema but are defined here. The `parameterList` type corresponds to the decision function input and the `resultList` type corresponds to the decision function output. This is because a decision function has specific inputs and outputs. When you write a test case for a decision function, then the test case input need to correspond to the inputs accepted by the decision function and the expected output need to correspond to the decision function outputs. `parameterList` and the `resultList` are single `complexType`s. For example, a decision function requires 10 inputs and 5 outputs, then the `parameterList` type will be a single `ComplexType` that collectively defines 10 different elements that need to be provided as the decision function input.

The following is a sample of the `Types.xsd`:

```

<?xml version = '1.0' encoding = 'UTF-8'?>

<schema xmlns="http://www.w3.org/2001/XMLSchema"
targetNamespace="http://xmlns.oracle.com/rules/BaseDictionary/BaseDF"
attributeFormDefault="unqualified" elementFormDefault="qualified"
xmlns:tns="http://xmlns.oracle.com/rules/BaseDictionary/BaseDF"
xmlns:xsd="http://www.w3.org/2001/XMLSchema"
xmlns:rules="http://xmlns.oracle.com/bpel/rules"
xmlns:ns1="http://xmlns.oracle.com/rulestest/datamodel">
<import namespace="http://xmlns.oracle.com/rulestest/datamodel"
schemaLocation="../../xsd/XMLFactTypes2.xsd"/>
<import namespace="http://xmlns.oracle.com/bpel/rules"
schemaLocation="DecisionFunctionPrimitiveTypes.xsd"/>
    <complexType name="parameterList">
        <sequence>
            <element name="tSongElement" type="ns1:tSong"/>
            <element ref="ns1:Artist"/>
        </sequence>
    </complexType>
    <complexType name="resultList">
        <sequence>
            <element name="tSongElement" type="ns1:tSong"/>
        </sequence>
    </complexType>
</schema>

```

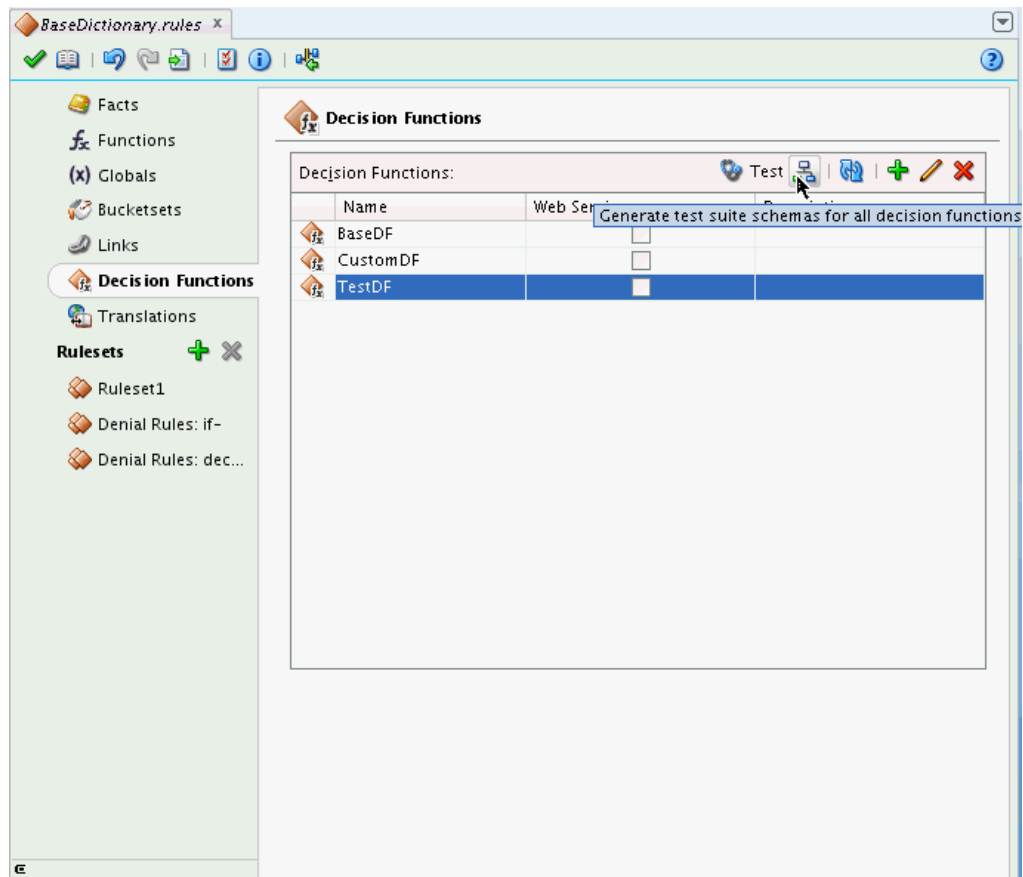
Every time there is an update to the decision function, the corresponding two schemas get updated. For example, if you change the name of the decision function, then the names of the associated schemas are changed. If you delete the decision functions, the corresponding schemas get deleted. Even changes to the inputs and outputs of the decision function results in the associated schemas getting changed. So a decision function and its corresponding test schemas are always in sync.

In case you make any changes to the decision function, for example delete the decision function, typically the schemas get deleted. When you click the **Undo** icon on the dictionary toolbar, the decision function is retrieved. However, the corresponding schemas remain deleted. You need to manually regenerate the schemas for the decision function in this case. So the sync between the decision function and its corresponding test schemas is not supported in undo and redo operations.

To manually regenerate the schemas:

Click the **Generate test suite schemas for all decision functions** icon on the dictionary toolbar as shown in [Figure 8-3](#).

**Figure 8-3** Manually Regenerating Test Suite Schemas



When you click the icon to regenerate the test suite schemas, a bulk regeneration activity takes place, and all the test suite schemas pertaining to all the available decision functions in the dictionary gets regenerated. If the schemas already exist, those are overwritten.

This activity is particularly used in the following cases:

- **When you have deleted or modified the decision function and have undone the changes:** This results in the decision function and the associated schemas getting out of sync. To get them in sync, you use this option so that the schemas are regenerated to correspond to the decision function.
- **When you migrate old dictionaries:** Consider a situation when you already have dictionaries from earlier releases with a number of decision functions defined and you want to use the rules testing feature for defining test suites for those decision functions to test them. In this case, either you have to open each decision function in the editor window after migrating, and then click the **OK** button. This would generate the corresponding test suite schemas. However, this is time-consuming when you have hundreds of decision functions. In this case, you can use the option of regenerating the schemas at one go.

---

---

**Note:** You need to ensure that the migrated decision functions have XML facts as inputs and outputs, else the inputs and outputs defined in the test suite schema files will be empty.

---

---

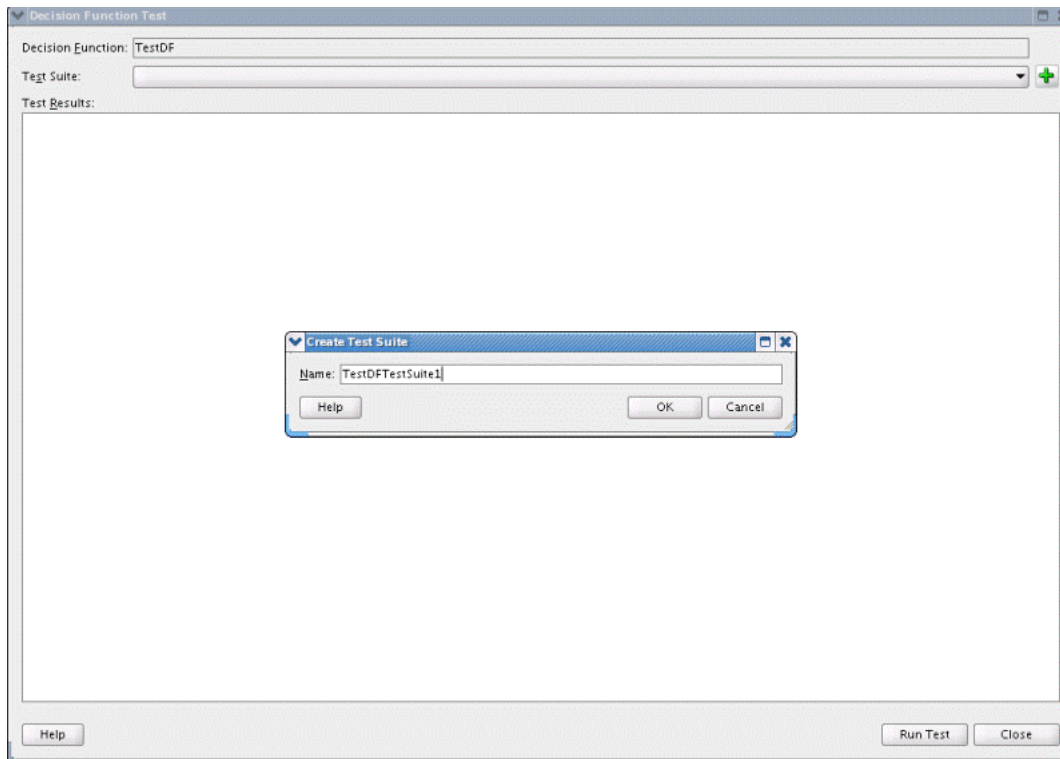
### 8.1.1.2 Testing the Rules

Once you have created the decision function for testing the rules, you can test rules.

To test rules:

1. Select the decision function name, say **TestDF** in this case, in the dictionary page and then click the **Test** button to display the Decision Function Test dialog box.
2. Click the Create icon (the plus sign) to display the Create Test Suite dialog box.
3. Enter the name for the test suite, say `TestDFTestSuite1` and click **OK** as displayed in [Figure 8-4](#).

Figure 8–4 Creating a Test Suite



4. Click **Close** in the Decision Function test dialog box.

When you create a test suite, a `<test suite name>.xml` file gets automatically generated and gets stored in the `<base dictionary name>` folder under the rules folder inside the testsuites folder. You can view the file in the Application Navigator window. For every test suite that you create, a corresponding XML file gets generated.

However, the newly created test suite file is empty, which does not contain any test case, input definitions, or output definitions.

5. Open the `<test suite name>.XML` and write the required test cases that conform to the test suite XSD file, in this case the TestDF XSDs corresponding to the decision function under test.

The following is a sample test suite file containing test cases:

```
<?xml version = '1.0' encoding = 'UTF-8'?>
<testSuite xmlns="http://xmlns.oracle.com/rules/test"
  xmlns:ns1="http://xmlns.oracle.com/bpel/rules"
  xmlns:ns2="http://xmlns.oracle.com/rules/BaseDictionary/BaseDF"
  xmlns:ns3="http://xmlns.oracle.com/rulestest/datamodel">
  <decisionFunction>G}-733d3b8f:12f76ddad3a:-7c02</decisionFunction>
  <testCase name="TestDFTestSuite1_TestCase1">
    <testInput>
      <ns2:tSongElement>
        <ns3:Title>Come What May</ns3:Title>
        <ns3:Composer>Artist</ns3:Composer>
        <ns3:Length>PT3M2S</ns3:Length>
        <ns3:Year>2010</ns3:Year>
        <ns3:Artist>
          <ns3:name>MJ</ns3:name>
          <ns3:age>20</ns3:age>
        </ns3:Artist>
      </ns2:tSongElement>
    </testInput>
  </testCase>
</testSuite>
```

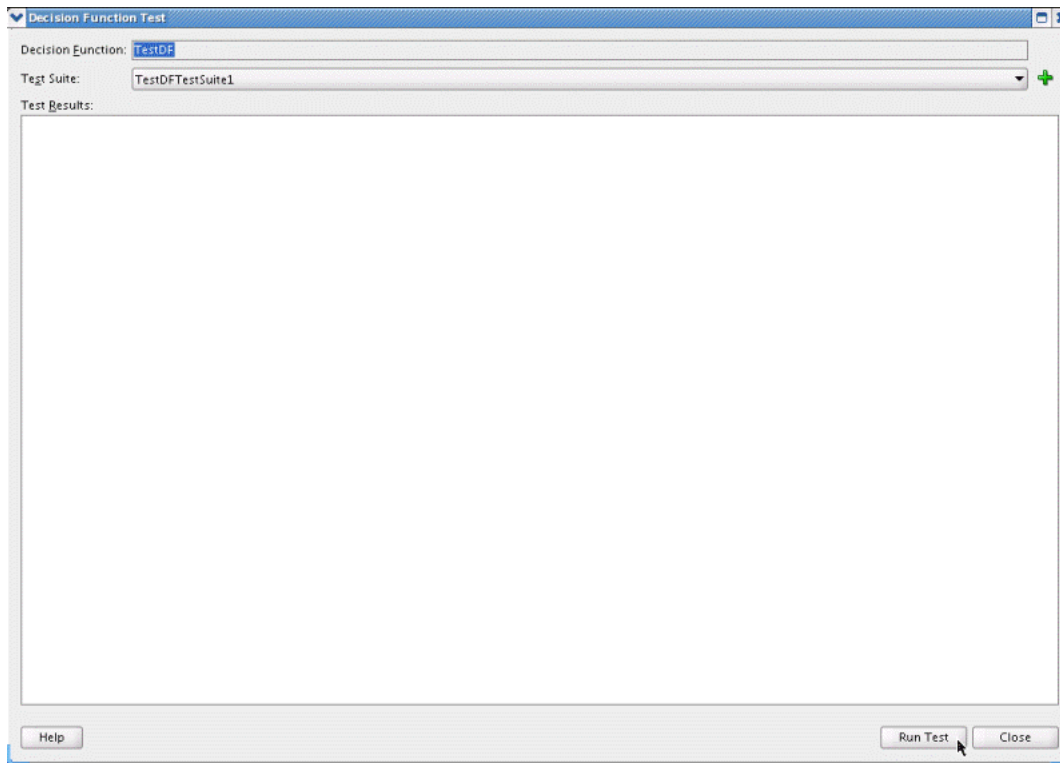


```

        <ns3:recordLabel>BMG Music</ns3:recordLabel>
      </ns3:Artist>
    </ns2:tSongElement>
    <ns3:Artist>
      <ns3:name>MJ</ns3:name>
      <ns3:age>20</ns3:age>
      <ns3:recordLabel>BMG Music</ns3:recordLabel>
    </ns3:Artist>
  </testInput>
  <expectedOutput>
    <ns2:tSongElement>
      <ns3:Title>Come What May</ns3:Title>
      <ns3:Composer>MJ</ns3:Composer>
      <ns3:Publisher>BMG Music</ns3:Publisher>
      <ns3:Length>PT3M2S</ns3:Length>
      <ns3:Year>2010</ns3:Year>
      <ns3:Artist>
        <ns3:name>MJ</ns3:name>
        <ns3:age>20</ns3:age>
        <ns3:recordLabel>BMG Music</ns3:recordLabel>
      </ns3:Artist>
    </ns2:tSongElement>
  </expectedOutput>
</testCase>
</testSuite>

```

6. Save the test suite file.
7. Open the dictionary page, select the decision function name (say **TestDF**), and click the **Test** button to display the Decision Function test dialog box.
8. Select **TestDFTestSuite1** from the Test Suite list and click **Run Test** as shown in [Figure 8-5](#).

**Figure 8–5 Running the Test**

This executes all the test cases in the test suite file.

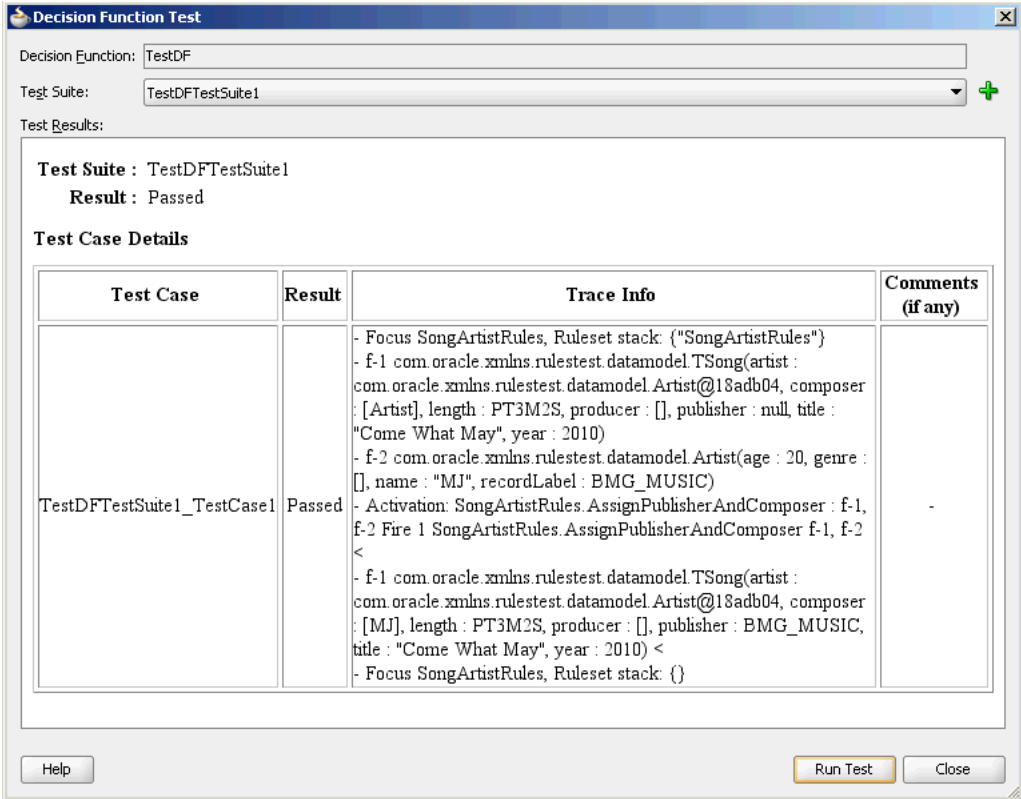
You can see the test details for the decision function in a tabular form.

The details contain the test suite name, the overall result, and the test case details, such as:

- The test case name
- The result of the test case
- The trace info such as which are the facts that were asserted, which are the rules that were activated, which are the rules that were fired and the resultant change in facts.

[Figure 8–6](#) displays the test results.

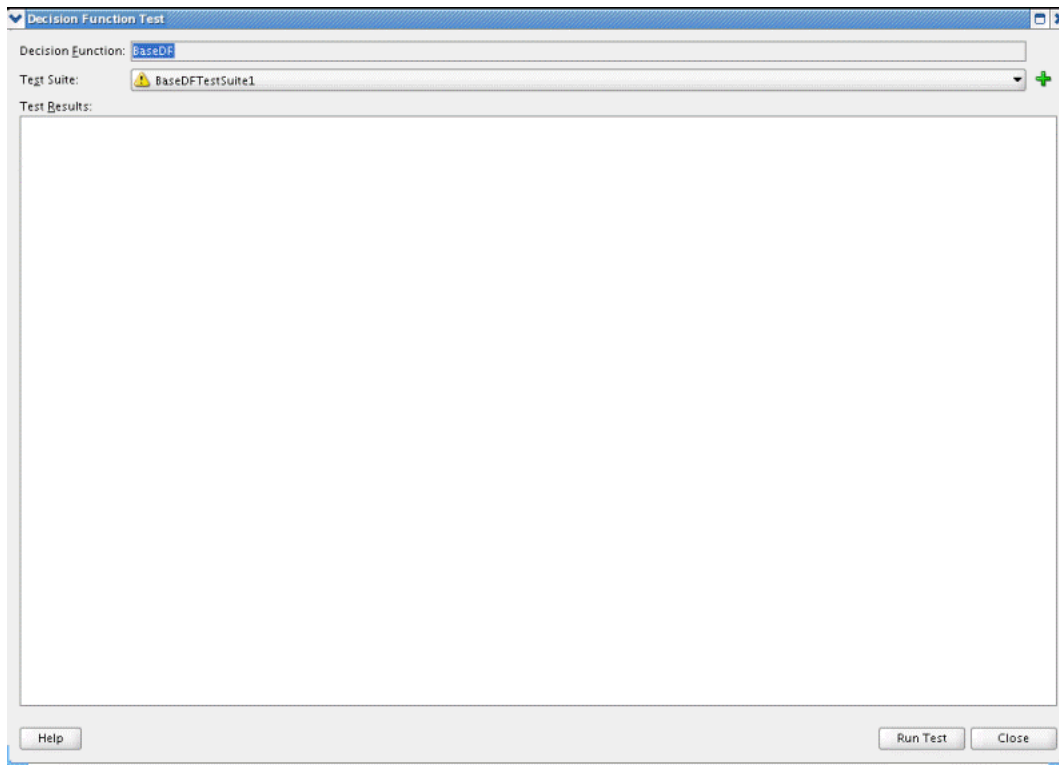
Figure 8-6 The Results Page



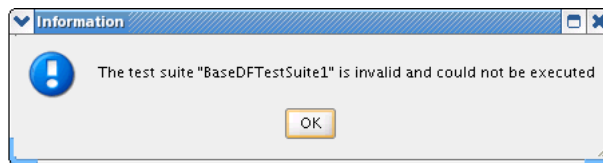
The Comments section in the Results page displays any error details in case a test case fails.

### 8.1.2 What You Need to Know About Validation of Test Suites

You may have a situation where your test suite XML file does not conform to the test suite XSD file. In that case when you open the Decision Function Test window, in the Test Suite list, adjacent to the test suite name, a yellow warning triangle appears as shown in Figure 8-7.

**Figure 8-7 Invalid Test Suite**

If you try to run an erroneous test suite, you will get the following error message:



If the test suite XML file is malformed, then the test suite name does not appear in the list of test suites in the Decision Function Test window. In addition, for an invalid dictionary, when you test the Decision Function, the following error message is displayed:

Dictionary is invalid, fix validation errors and try again.

### 8.1.3 What You Need to Know About Testing Linked Dictionaries

Consider a situation, where you have a base dictionary and a custom dictionary. The custom dictionary has a link to the base dictionary.

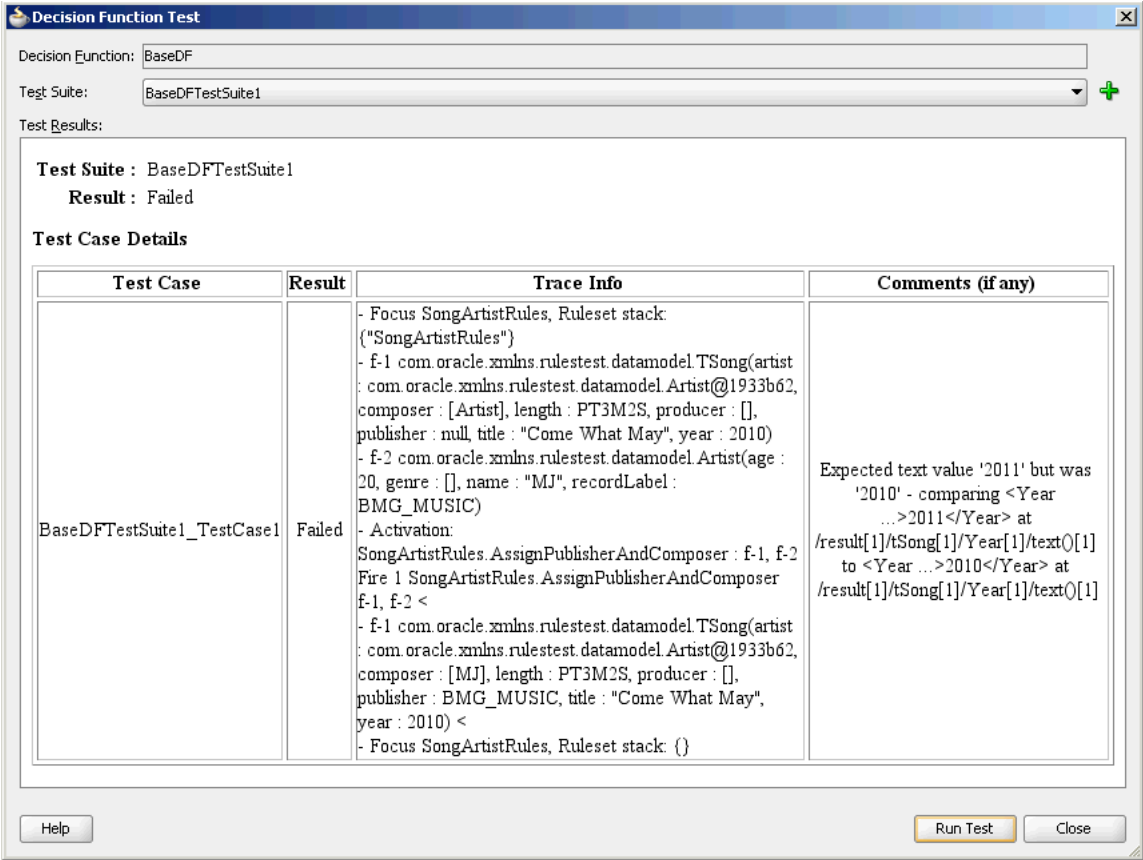
Now, navigate to the Decision Functions section of the custom dictionary. Note that the list of decision functions in the custom dictionary includes the decision functions from the linked/base dictionary. You can test the decision functions of the base dictionary from the custom dictionary.

### 8.1.4 What You Need to Know About Failure of Test Suites

In case your test case fails, the Results page displays the probable reasons of failure in the Comments section.

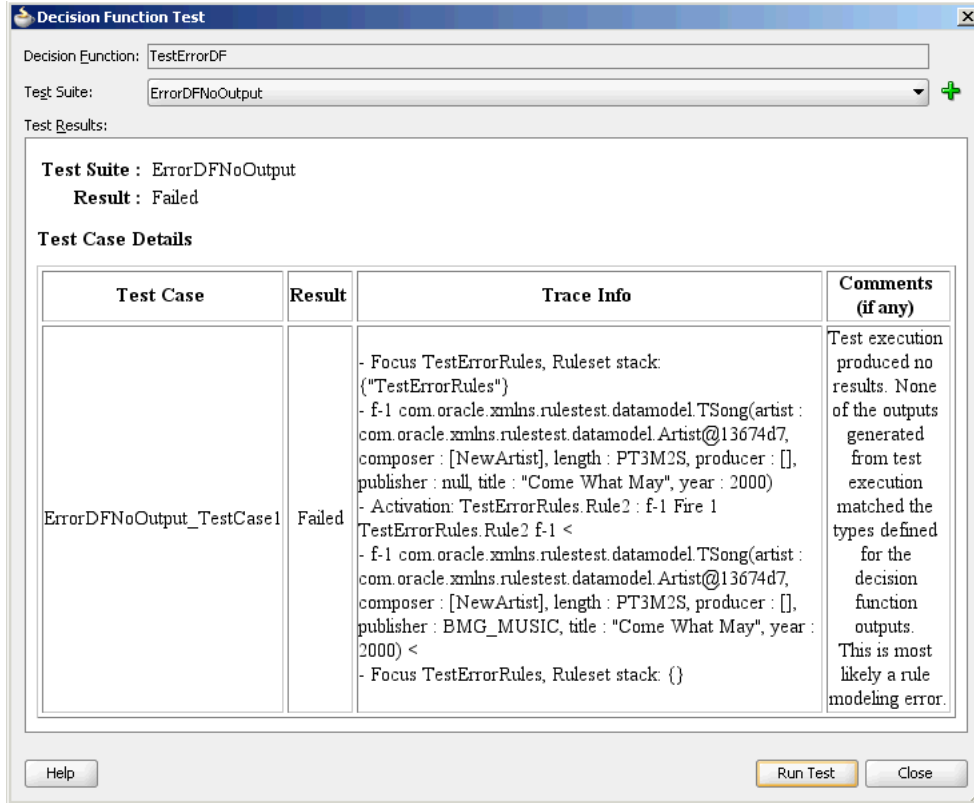
A test case can fail due to the following reasons:

- The expected output specified for the test case is different from the actual output as the following:



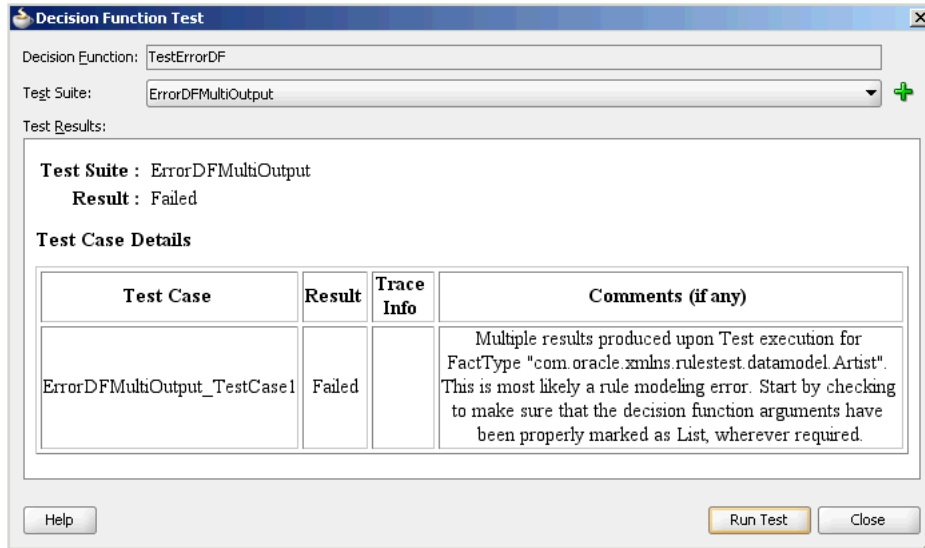
The Comments section clearly states that there is a mismatch between the expected output and the actual output.

- The test case executes, but no output is generated as the following:



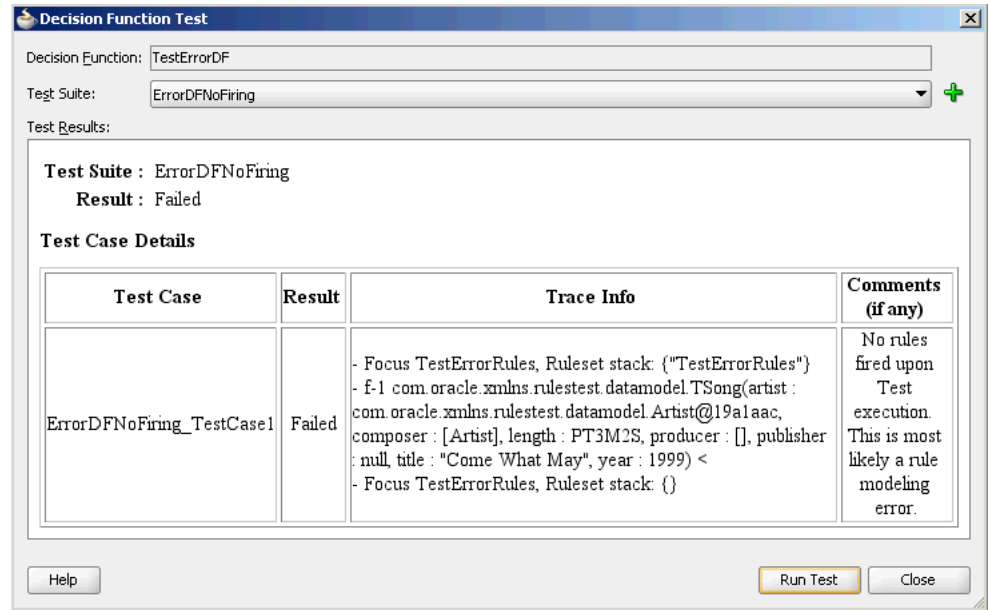
You can see that the Comments section displays that the test generated no results and some more details on the probable cause.

- The test case executes, but multiple outputs are generated as the following:



The Comments section displays that multiple outputs were generated on test execution along with some details on the probable cause.

- The test case does not fire any rule as the following:



This can be because the asserted fact failed to activate any rule resulting in no rules getting fired. So, the Comments section indicates that this may be due to a rule modelling error, because in all probabilities, the provided input failed to match any rule condition.

### 8.1.5 How to Test a Decision Function Using an Oracle Business Rules Function

You can test rulesets by creating a decision function and calling the decision function from Rules Designer with an Oracle Business Rules function. In the body of the Oracle Business Rules function you create input facts, call a decision function, and validate the facts output from the decision function. For more information, see [Section 6.1, "Introduction to Decision Functions"](#) and [Section 2.5, "Working with Oracle Business Rules Functions"](#).

#### To test a decision function using an Oracle Business Rules function:

1. Confirm that your dictionary is valid.  
For more information on dictionary validation, see [Section 4.4.4, "How to Validate a Dictionary"](#)
2. In Rules Designer, select the **Functions** navigation tab.
3. In the **Functions** area click the **Create...** icon.
4. Enter the function name in the **Name** field, or use the default name.
5. Select the return type from the **Return Type** list.  
For a test function, select `boolean`.
6. In the **Arguments** table, confirm that there are no arguments. For a test function, you cannot specify any arguments.
7. In the **Body** area, enter the test function body.

In the body of the test function you can call a decision function using `assign new` to call and get the return value of the decision function (in the body of the test function you create input facts, call a decision function, and validate the facts output from the decision function).

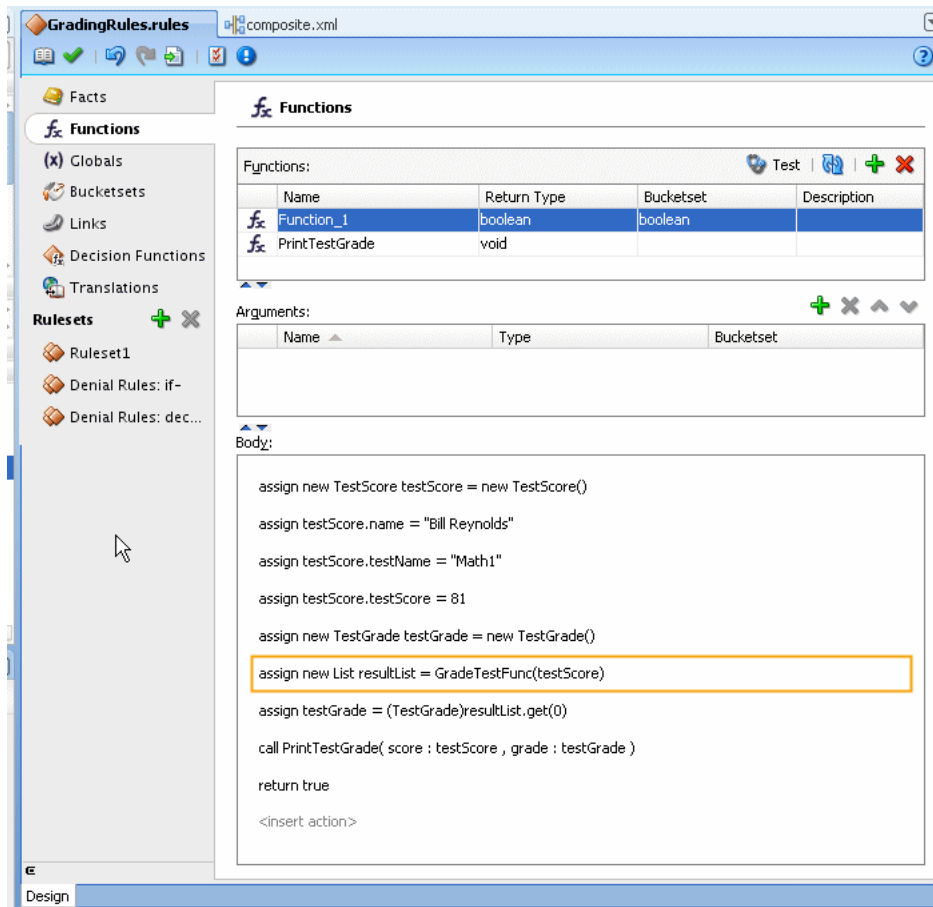
A decision function call returns a `List`. Thus, to test a decision function in a test function you do the following:

- You create the input data as required for the decision function input arguments.
- You call the decision function with the arguments you create in the test function.
- You place results in a `List`, for example, in the following:  

```
assign new List resultList = DecisionFunction_1(testScore)
```

Figure 8–8 shows a test function that calls a decision function.

**Figure 8–8 Test Function to Call a Decision Function that Returns a List**



8. Select the function and click the **Test Function** icon.

The function is executed. The output is shown in a Function Test Result dialog, as Figure 8–9 shows.



**Figure 8–9 Test Function Results for Grade Test**

9. Click **OK** to dismiss the Function Test Result dialog.

### 8.1.6 What You Need to Know About Testing Decision Functions

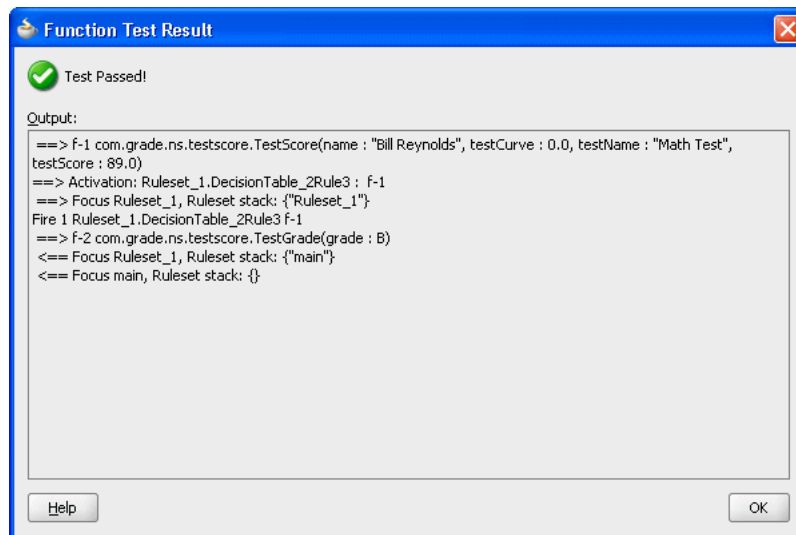
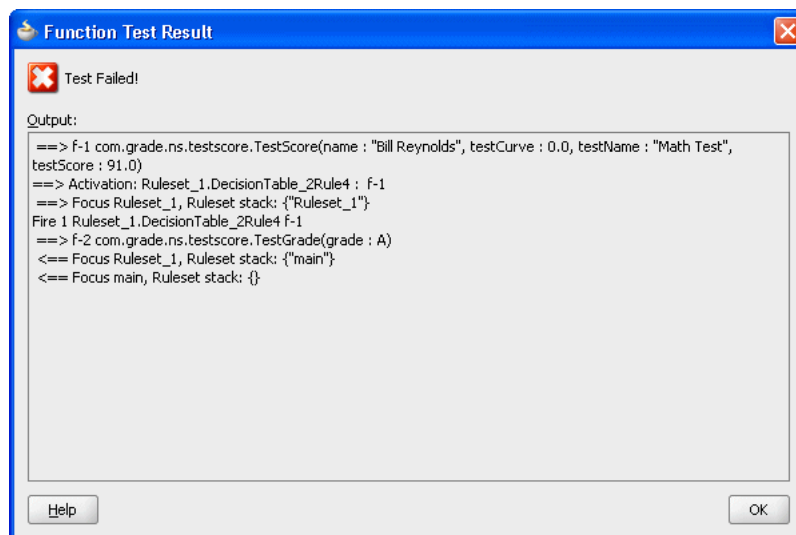
You can use Oracle Business Rules Functions to test decision functions from within Rules Designer. Keep the following points in mind when using a test function:

- The **Test Function** icon is gray if the dictionary associated with the test Oracle Business Rules Function contains any validation warnings. The **Test Function** icon is only shown when the dictionary validates without warnings.
- To enable logging you can call `RL.watch.all()`. For more information on RL Language functions, see *Rules Language Reference for Oracle Business Process Management*. In this guide, `RL.watch.all()` is an alias for the RL Language function `watchAll()`.
- As an alternative to the example shown in [Figure 8–8](#), you can enter the function body that is shown in [Example 8–1](#). This function runs and shows the `RL.watch.all()` output. The dialog shows "Test Passed" when the grade is in the B range as shown in [Figure 8–10](#). The dialog shows "Test Failed" when the grade asserted is not in the B range, as shown in [Figure 8–11](#).

#### **Example 8–1 Function Body with True or False Return Value**

```
call RL.watch.all()
assign new TestScore testScore = new TestScore()
modify (testScore, name: "Bill Reynolds", testName: "Math Test", testScore: 81)
assign new TestGrade testGrade = (TestGrade)DecisionFunction_1(testScore).get(0)
return testGrade.grade == Grade.B
```

For the `testScore` value 81, this function returns "Test Passed" as shown in [Figure 8–10](#). For the `testScore` value 91, this returns "Test Failed", as shown in [Figure 8–11](#).

**Figure 8–10 Test Passed Test Function Output****Figure 8–11 Test Failed Test Function Output**

## 8.2 Testing Oracle Business Rules at Runtime

In a SOA application that uses Oracle Business Rules with a Decision Service you can test rules at runtime with Oracle Enterprise Manager Fusion Middleware Control Console Test function.

For more information on using the Test function, see *Administering Oracle SOA Suite and Oracle Business Process Management Suite*.

---

---

# Creating a Rule-enabled Non-SOA Java EE Application

This chapter describes how to use Oracle JDeveloper to create a rule-enabled non-SOA Java EE application with Oracle Business Rules. It also shows a sample application, a Java Servlet, which runs as a Java Enterprise Edition (EE) application using Oracle Business Rules (this describes using of Oracle Business Rules without a SOA composite).

The chapter includes the following sections:

- [Section 9.1, "Introduction to the Grades Sample Application"](#)
- [Section 9.2, "Creating an Application and a Project for Grades Sample Application"](#)
- [Section 9.3, "Creating Data Model Elements and Rules for the Grades Sample Application"](#)
- [Section 9.4, "Adding a Servlet with Rules SDK Calls for Grades Sample Application"](#)
- [Section 9.5, "Adding an HTML Test Page for Grades Sample Application"](#)
- [Section 9.6, "Preparing the Grades Sample Application for Deployment"](#)
- [Section 9.7, "Deploying and Running the Grades Sample Application"](#)

The source code for Oracle Business Rules-specific samples and SOA samples are available online in the Oracle SOA Suite samples page.

## 9.1 Introduction to the Grades Sample Application

The Grades application provides a sample use of Oracle Business Rules in a Java Servlet. The servlet uses Rules SDK Decision Point API. This sample demonstrates the following:

- Creating rules in an Oracle Business Rules dictionary using an XSD schema that defines the input and the output data, and the facts for the data model. In this case you provide the XSD schema in the file `grades.xsd`.
- Creating a servlet that uses Oracle Business Rules to determine a grade for each test score that is input.
- Creating a test page to supply input test scores and to submit the data to the grades servlet.
- Deploying the application, running it, submitting test values, and seeing the output.

## 9.2 Creating an Application and a Project for Grades Sample Application

To create the application and the project for the grades sample application, do the following:

- Create a Fusion Web Application (ADF)
- Create a project in the application
- Add the schema to define the inputs, outputs, and the objects for the data model
- Create an Oracle Business Rules dictionary in the project

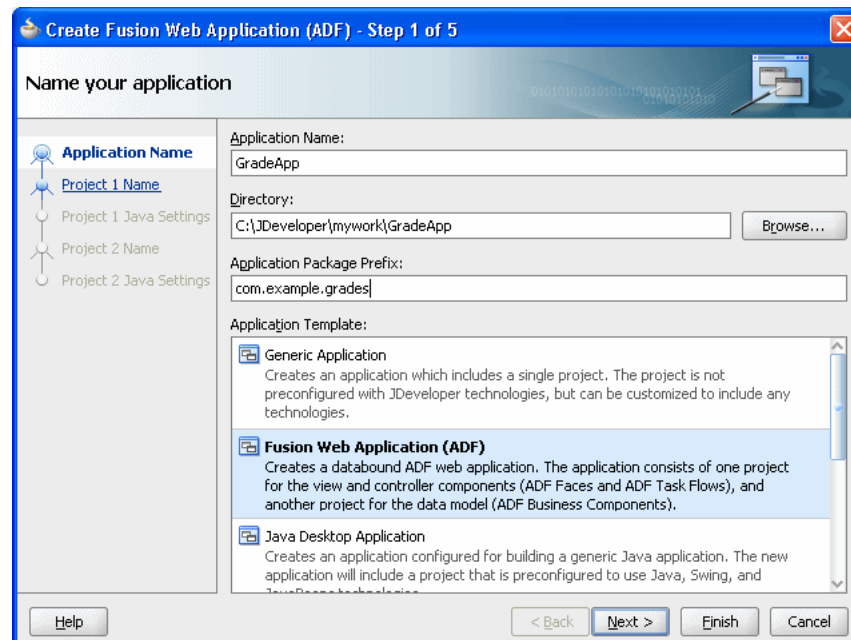
### 9.2.1 How to Create a Fusion Web Application for the Grades Sample Application

To work with Oracle Business Rules and create a Java EE application, you first need to create the application in Oracle JDeveloper.

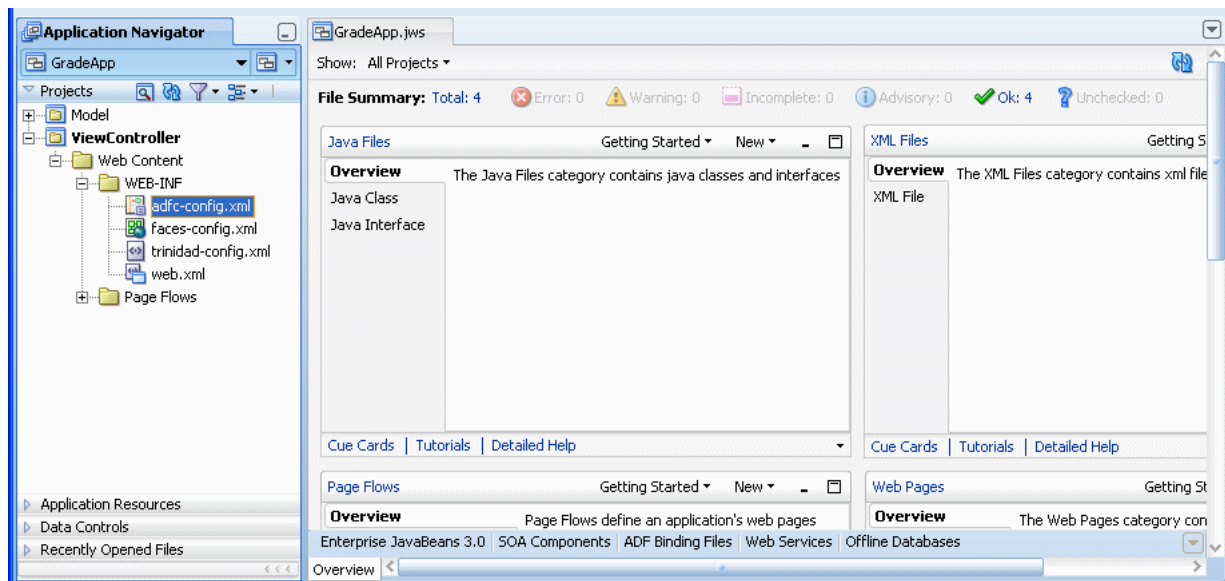
**To create a fusion web application (ADF) for grades:**

1. Create an application. You can do this in the Application Navigator by selecting **New Application...**, or from the **Application** menu list by selecting **New Application...**
2. In the Name your application dialog enter the application options, as shown in [Figure 9-1](#):
  - a. In the **Application Template** area, select **Fusion Web Application**.
  - b. In the **Application Name** field, enter an application name. For example, enter `GradeApp`.
  - c. In the **Directory** field, specify a directory name or accept the default.
  - d. In the **Application Package Prefix** field, enter an application package prefix. For example, `com.example.grades`.

The prefix, followed by a period applies to objects created in the initial project of an application.

**Figure 9–1 Adding GradeApp Application**

3. Click **Finish**. After creating the application Oracle JDeveloper displays the file summary, as shown in [Figure 9–2](#).

**Figure 9–2 New Grades Application Named GradeApp**

## 9.2.2 How to Develop Accessible ADF Faces Pages

Oracle software implements the standards of the Web Content Accessibility Guidelines (WCAG) 1.0 Level AA using an interpretation of the standards at <http://www.oracle.com/accessibility/standards.html>

ADF Faces user interface components have built-in accessibility support for visually and physically impaired users. User agents such as a web browser rendering to nonvisual media such as a screen reader can read component text descriptions to

provide useful information to impaired users. Access key support provides an alternative method to access components and links using only the keyboard. ADF Faces accessibility audit rules provide direction to create accessible images, tables, frames, forms, error messages and popup windows using accessible HTML markup.

For information on how to develop accessible ADF Faces pages, see, "Developing Accessible ADF Faces Pages" in *Oracle Fusion Middleware Web User Interface Developer's Guide for Oracle Application Development Framework*.

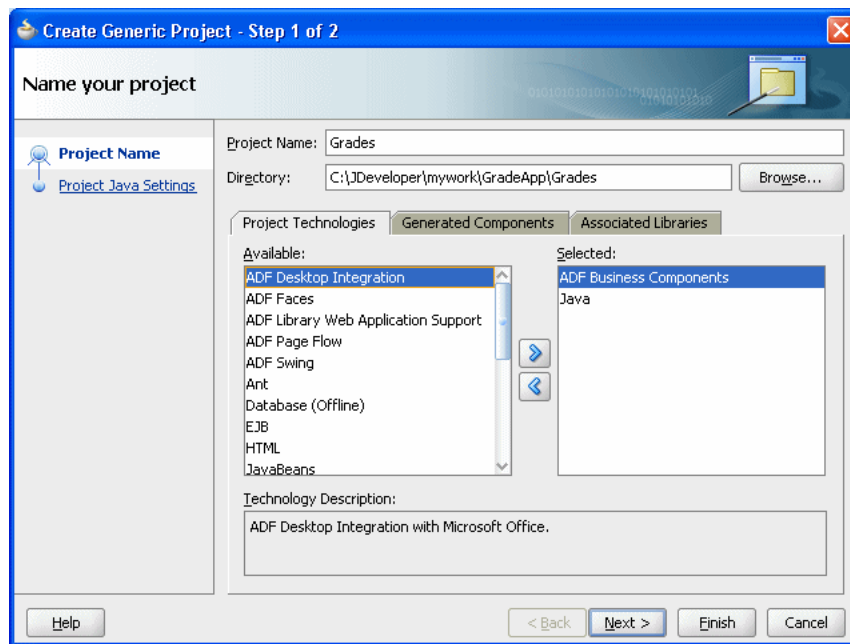
### 9.2.3 How to Create the Grades Project

In the Grades sample application you do not use the Model or ViewController projects. You create a project in the application for the grades sample project.

**To create a grades project:**

1. In the GradeApp application, in the Application Navigator, from the Application Menu select **New Project...**
2. In the New Gallery, in the **Items** area select **Generic Project**.
3. Click **OK**.
4. In the Name your project page enter the values as shown in [Figure 9-3](#):
  - a. In the **Project Name** field, enter a name. For example, enter Grades.
  - b. Enter or browse for a directory name, or accept the default.
  - c. Select the **Project Technologies** tab.
  - d. In the **Available** area double-click **ADF Business Components** to move this item to the **Selected** area. This also adds Java to the **Selected** area as shown in [Figure 9-3](#).

**Figure 9-3 Adding Generic Project to the Grades Application**



5. Click **Finish**. This adds the Grades project.

## 9.2.4 How to Add the XML Schema and Generate JAXB Classes in the Grades Project

To create the Grades sample application you need to use the `grades.xsd` file, shown in [Example 9–1](#). You can create and store the schema file locally and then use Oracle JDeveloper to copy the file to your project.

### Example 9–1 `grades.xsd` Schema

```
<?xml version= '1.0' encoding= 'UTF-8' ?>
<xs:schema targetNamespace="http://example.com/grades"
  xmlns:xs="http://www.w3.org/2001/XMLSchema"
  xmlns:tns="http://example.com/grades"
  attributeFormDefault="qualified" elementFormDefault="qualified"
  xmlns:xjc="http://java.sun.com/xml/ns/jaxb/xjc"
  xmlns:jaxb="http://java.sun.com/xml/ns/jaxb"
  jaxb:extensionBindingPrefixes="xjc"
  jaxb:version="2.0">

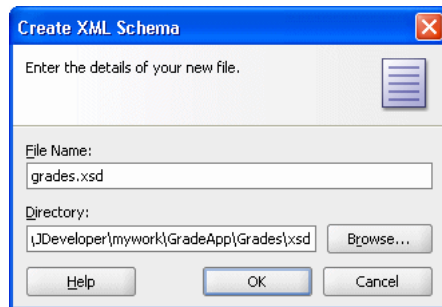
  <xs:element name="TestScore">
    <xs:complexType>
      <xs:sequence>
        <xs:element name="name" type="xs:string"/>
        <xs:element name="testName" type="xs:string"/>
        <xs:element name="testScore" type="xs:double"/>
        <xs:element name="testCurve" type="xs:double"/>
      </xs:sequence>
    </xs:complexType>
  </xs:element>
  <xs:element name="TestGrade">
    <xs:complexType>
      <xs:sequence>
        <xs:element name="grade" type="tns:Grade"/>
      </xs:sequence>
    </xs:complexType>
  </xs:element>
  <xs:simpleType name="Grade">
    <xs:restriction base="xs:string">
      <xs:enumeration value="A"/>
      <xs:enumeration value="B"/>
      <xs:enumeration value="C"/>
      <xs:enumeration value="D"/>
      <xs:enumeration value="F"/>
    </xs:restriction>
  </xs:simpleType>
</xs:schema>
```

#### To add the XML schema to the grades project:

1. Save the schema file shown in [Example 9–1](#) to a local file named `grades.xsd`.
2. In the Application Navigator select the **Grades** project.
3. Right-click and in the context menu select **New...**
4. In the New Gallery select the **All Technologies** tab.
5. In the **Categories** area, expand **General** and select **XML**.
6. In the **Items** area, select **XML Schema**.
7. Click **OK**.
8. In the Create XML Schema dialog, in the **File Name** field enter `grades.xsd`.

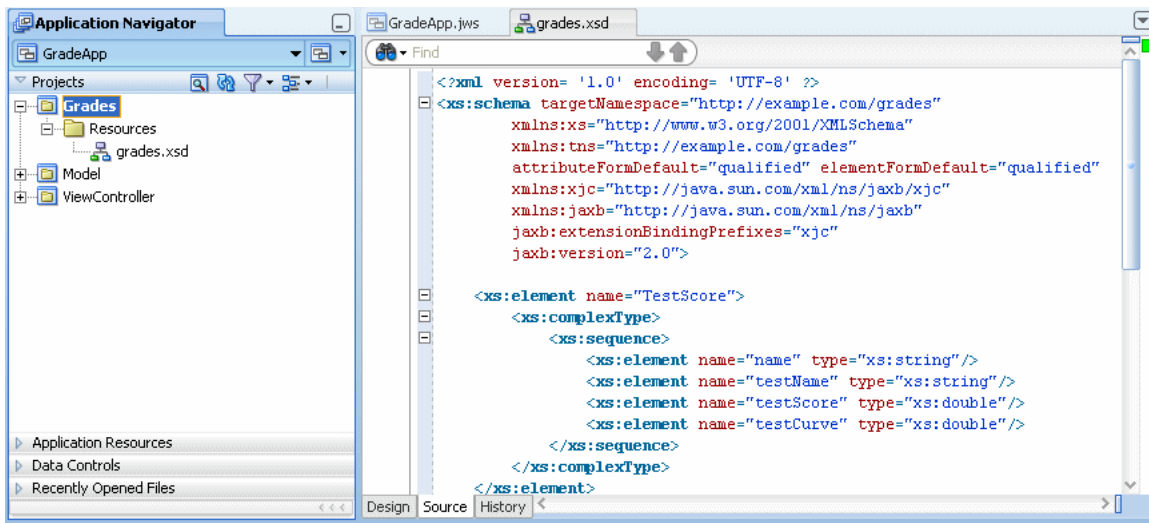
- In the Create XML Schema dialog, in the **Directory** field add the `xsd` directory to the Grades project path name, as shown in [Figure 9-4](#).

**Figure 9-4 Adding Schema to Grades Project in `xsd` Directory**



- Click **OK**.
- In the `grades.xsd` file, select the **Source** tab.
- Copy the schema shown in [Example 9-1](#) to the `grades.xsd` in the Grades project, as shown in [Figure 9-5](#).

**Figure 9-5 Shows the `grades.xsd` Schema File in the Grades Project**



**To generate JAXB 2.0 content model from grades schema:**

- In the Application Navigator, in the Grades project expand **Resources** and select `grades.xsd`.
- Right-click and in the context menu select **Generate JAXB 2.0 Content Model**.
- In the JAXB 2.0 Content Model from XML Schema dialog, click **OK**.

### 9.2.5 How to Create an Oracle Business Rules Dictionary in the Grades Project

After creating a project in Oracle JDeveloper create business rules within the Grades project.

To use business rules with Oracle JDeveloper, you do the following:

- Add a business rule to the project and import `grades.xsd` schema

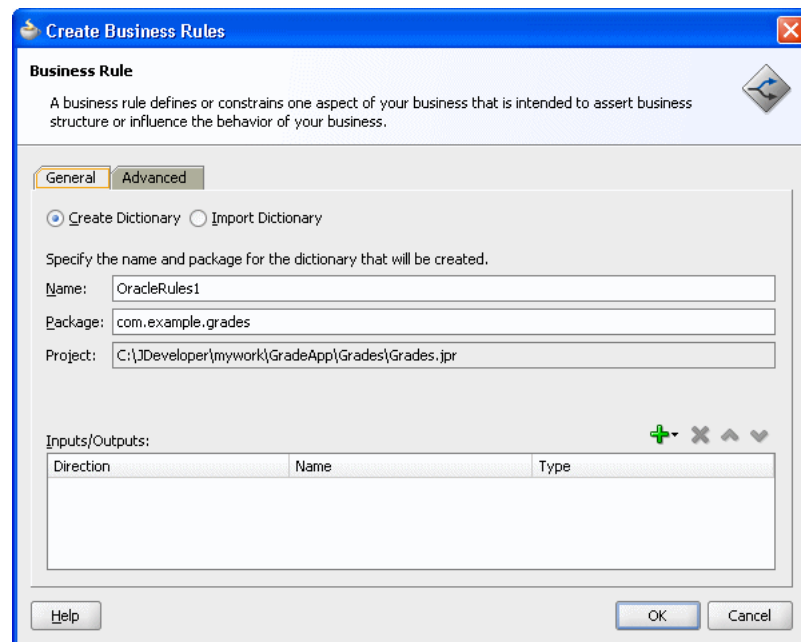


- Create input and output variables
- Create an Oracle Business Rules dictionary in the project

**To create a business rules dictionary in the business tier:**

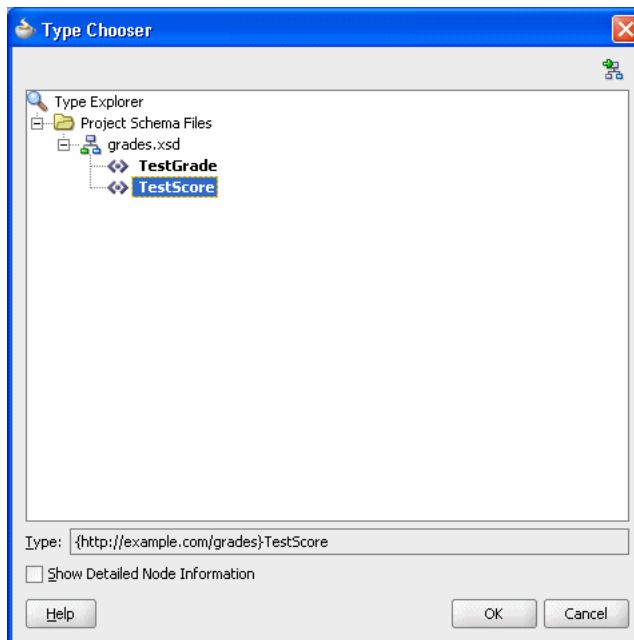
1. In the Application Navigator, select the Grades project.
2. Right-click and in the context menu select **New...**
3. Select the **All Technologies** tab.
4. In the New Gallery, in the **Categories** area, expand Business Tier and select **Business Rules**.
5. In the New Gallery, in the **Items** area, select **Business Rules**.
6. Click **OK**. Oracle JDeveloper displays the Create Business Rules dialog, as shown in [Figure 9–6](#).

**Figure 9–6 Adding a Business Rule to Grades with the Create Business Rules Dialog**



7. In the **Name** field, enter a name to name the dictionary. For example, enter `GradingRules`.
8. To add an input, from the list next to the **Add** icon select **Input...**
9. In the Type Chooser, expand the Project Schemas Files folder and expand `grades.xsd`.
10. Select the input **TestScore**, as shown in [Figure 9–7](#).

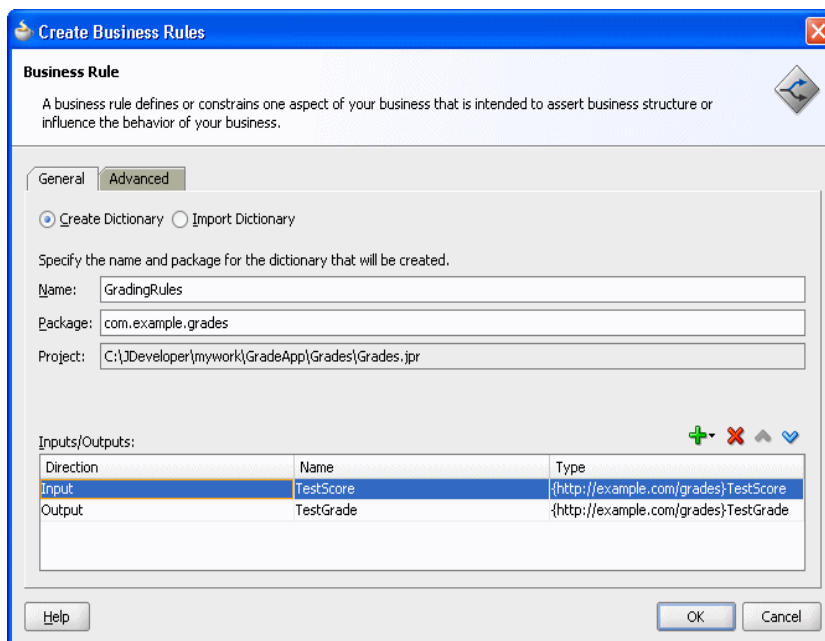
**Figure 9-7 Shows the Type Chooser Dialog with TestScore Element**



11. On the Type Chooser window, click **OK**. This displays the Create Business Rules dialog.
12. In the Create Business Rules dialog, in a similar manner to the input add the output by selecting **Output...** to add the output element `TestGrade` from the `grades.xsd` schema.

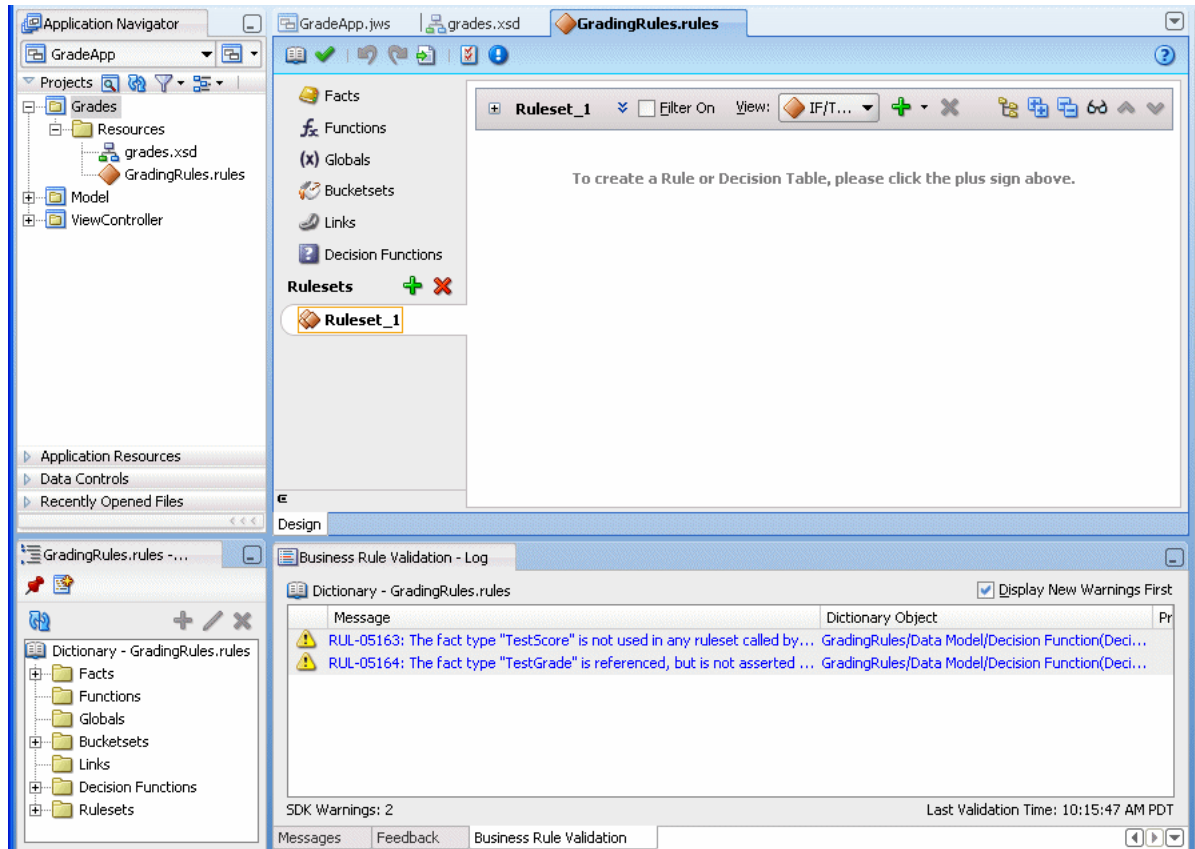
The resulting Create Business Rules dialog is shown in [Figure 9-8](#).

**Figure 9-8 Create Business Rules Dialog with Grades Input and Output**



13. Click **OK**. Oracle JDeveloper creates the GradingRules dictionary as shown in Figure 9–9.
14. In the **File** menu, select **Save All** to save your work.

**Figure 9–9** Shows the New Grading Rules Dictionary



Note that the business rule validation log area for the new dictionary shows several validation warnings. You remove these validation warning messages as you modify the dictionary in later steps.

### 9.3 Creating Data Model Elements and Rules for the Grades Sample Application

To create the data model and the business rules for the Grades sample application, do the following:

- Create Bucketsets for grades
- Create rules by adding a Decision Table for grades
- Split the Decision Table and add actions for rules
- Rename the default decision function

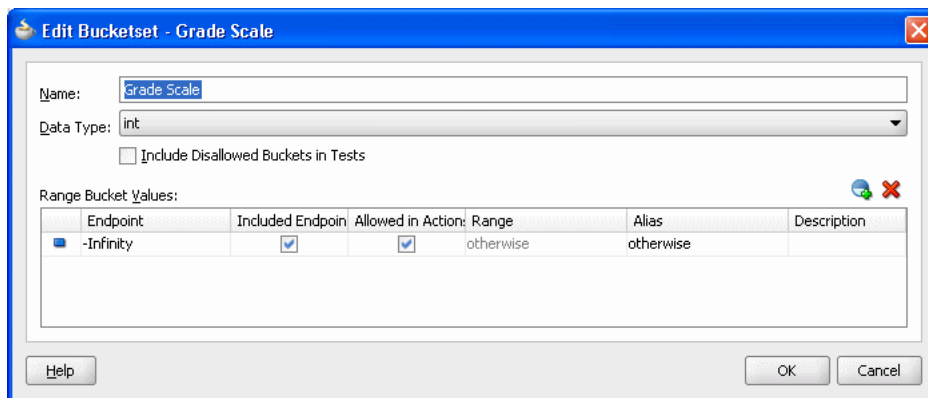
### 9.3.1 How to Create Bucketsets for Grades Sample Application

In this example you associate a bucketset with a fact type. This supports using a Decision Table where you need bucketsets that specify how to draw values for each cell in the Decision Table (for the conditions in the Decision Table).

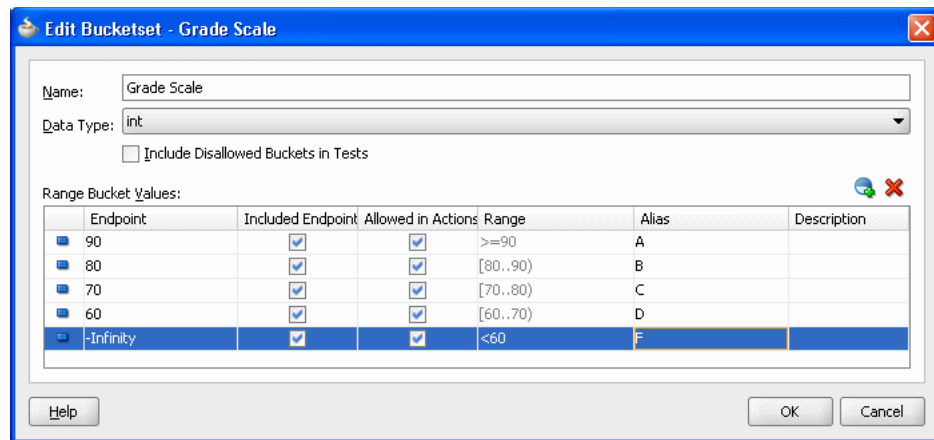
#### To create the bucketset for the grades sample application:

1. In Rules Designer, select the **Bucketsets** navigation tab.
2. From the list next to the **Create BucketSet...** icon, select **List of Ranges**.
3. For the bucketset, double-click in the Name field to select the default name.
4. Enter `Grade Scale`, and press **Enter** to accept the bucketset name.
5. In the **Bucketsets** table, double-click the bucket icon for the Grade Scale bucketset to display the Edit Bucketset dialog as shown in [Figure 9–10](#).

**Figure 9–10** Grade Scale Bucketset



6. In the Edit Bucketset dialog, click **Add Bucket** to add a bucket.
7. Click **Add Bucket** three times to add three more buckets.
8. In the **Endpoint** field, enter 90 for the top endpoint and press **Enter** to accept the new value.
9. For the next bucket, in the **Endpoint** field enter 80 and press **Enter** to accept the new value.
10. Similarly, for the next two buckets enter values in the **Endpoint** field, values 70 and 60.
11. In the **Included Endpoint** field for each bucket select each checkbox.
12. Modify the **Alias** field for each value to enter the values A, B, C, D, and F, for each corresponding range, as shown in [Figure 9–11](#) (press **Enter** after you add each alias).

**Figure 9–11 Grade Scale Bucketset with Grade Values Added****To associate a bucketset with a fact property:**

To prepare for creating Decision Tables you can associate a global bucketset with fact properties in the data model. In this way condition cells in a Decision Table **Conditions** area can use the bucketset when you create a Decision Table.

1. In Rules Designer, select the **Facts** navigation tab.
2. In the **Facts** navigation tab select the **XML Facts** tab.
3. Double-click the **XML fact** icon for the **TestScore** fact. This displays the Edit XML Fact dialog.
4. In the Edit XML Fact dialog select the **testScore** property.
5. In the **Bucketset** field, from the list select **Grade Scale**.
6. Click **OK**.

**9.3.2 How to Add a Decision Table for Grades Sample Application**

You create rules in a Decision Table to process input facts and to produce output facts, or to produce intermediate conclusions that Oracle Business Rules can further process using additional rules or in another Decision Table.

To use a Decision Table for rules in this application you work with facts representing a test score. Then, you use a Decision Table to create rules based on the test score to produce a grade.

**To add a decision table for Grades application:**

1. In Rules Designer, select **Ruleset\_1** under the **Rulesets** navigation tab.
2. In **Ruleset\_1**, click the **Add** icon and from the list select **Create Decision Table**. This creates **DecisionTable\_1**. You can ignore the warning messages shown in the Business Rule Validation log area. You remove these warning messages in later steps.
3. In the Decision Table, **DecisionTable\_1**, click the **Add** icon and from the list select **Condition**.
4. In the Decision Table, double-click **<edit condition>**. Then, in the variables navigator expand **TestScore** and select **testScore**. This enters the expression `TestScore.testScore` for condition C1.

If you view the rules validation log, you should see warning messages. You remove these warning messages as you modify the Decision Table in later steps.

**To add an action to a decision table:**

You add an action to the Decision Table to assert a new Grade fact.

1. In the Decision Table, click the **Add** icon and from the list select **Action** and select **Assert New**.
2. In the **Actions** area, double-click **assert new** (.  
This displays the Action Editor dialog.
3. In the Action Editor dialog, in the **Facts** area select **TestGrade**.
4. In the Action Editor dialog, in the Properties table for the property **grade**, select the **Parameterized** checkbox and the **Constant** checkbox.  
This specifies that each rule independently sets the grade.
5. In the Action Editor dialog select the **Always Selected** checkbox.
6. In the Action Editor dialog click **OK**.
7. Select **Save All** from the **File** main menu to save your work.

Next you add rules to the Decision Table and specify an action for each rule.

### 9.3.3 How to Add Actions in the Decision Table for Grades Sample Application

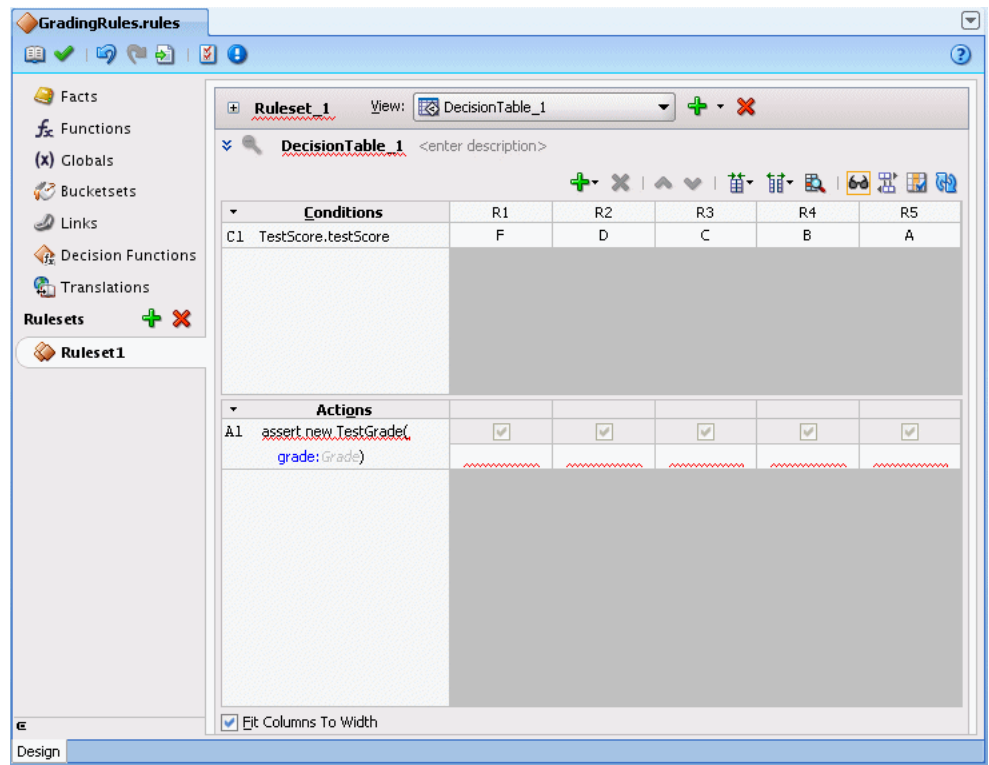
You can use the Decision Table split operation to create rules for the bucketset associated with the conditions row in the Decision Table. This creates one rule for every bucket.

**To split the decision table:**

1. Select the Decision Table.
2. Click the **Split Table** icon and from the list select **Split Table**.  
The split operation eliminates the "do not care" cells from the table. The table now shows five rules that cover all ranges, as shown in [Figure 9-12](#).

These steps produce validation warnings for action cells with missing expressions. You fix these problems in later steps when you define actions for each rule.

Figure 9–12 Splitting a Decision Table Using Split Table Operation for Grades

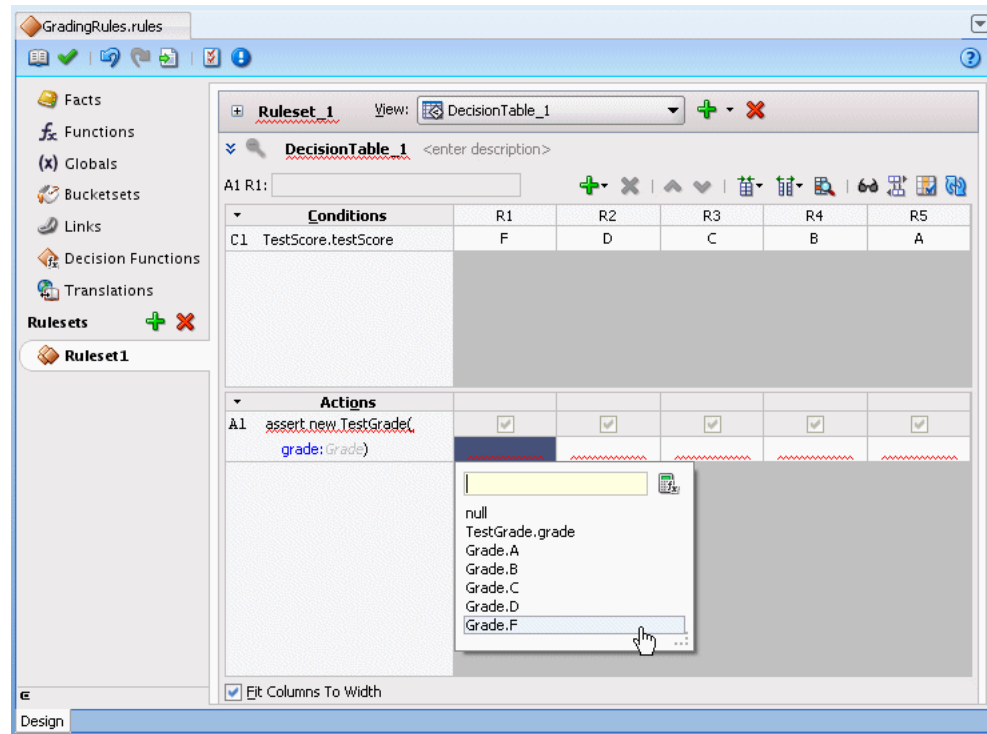


#### To add actions for each rule in the decision table:

In the Decision Table you specify a value for the result, a grade property, associated with TestGrade for each action cell in the **Actions** area. The possible choices for each grade property are the valid grades. In this step you fill in a value for each of the rules. The values you enter correspond to the conditions that form each rule in the Decision Table.

1. In the **Actions** area, double-click the action cell for rule **R1** as shown in [Figure 9–13](#).

**Figure 9–13 Adding Action Cell Values to Grades Decision Table**



2. In the list select the corresponding value for the action cell. For example, select **Grade.F**.
3. For each of the remaining action cells select the appropriate value for the buckets for **TestScore**: D, C, B, and A.

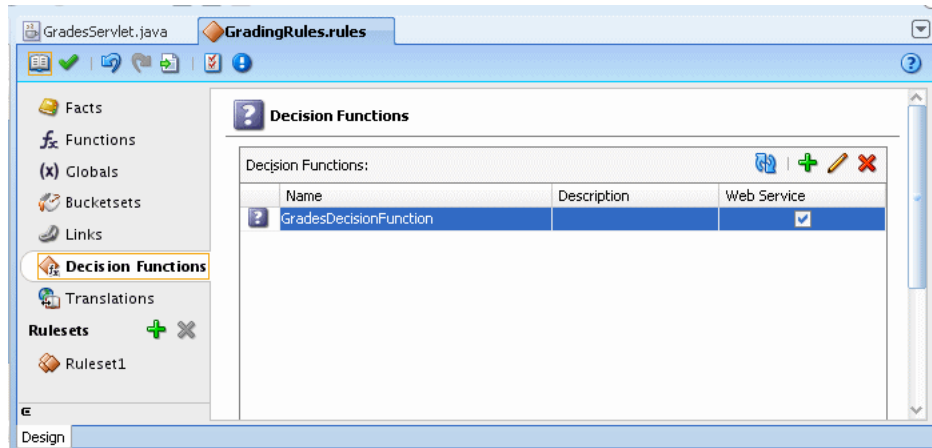
### 9.3.4 How to Rename the Decision Function for Grades Sample Application

The name you specify when you use a decision function with a Rules SDK Decision Point must match the name of a decision function in the dictionary. To make the name match, you can rename the decision function to any name you like. Thus, for this example you rename the default decision function to use the name `GradesDecisionFunction`.

**To rename the decision function:**

1. In the Application Navigator, in the **Grades** project, expand the **Resources** folder and double-click the dictionary **GradingRules.rules**.
2. Select the **Decision Functions** navigation tab.
3. In the **Name** field in the **Decision Functions** table edit the decision function name to enter the value `GradesDecisionFunction`, and then press **Enter**, as shown in [Figure 9–14](#).



**Figure 9–14 Renaming Decision Function in Rules Designer**

## 9.4 Adding a Servlet with Rules SDK Calls for Grades Sample Application

The Grades sample application includes a servlet that uses the Rules Engine.

To add this servlet with Oracle Business Rules you need to understand the important Rules SDK methods. Thus, to use the Oracle Business Rules dictionary you created with Rules Designer, you do the following:

- Create initialization steps that you perform one time in the servlet `init` routine.
- Create a servlet `service` routine using the Rules SDK Decision Point API.
- Perform steps to add the servlet code in the project.

For more information on Rules SDK Decision Point API, see [Chapter 7, "Working with Rules SDK Decision Point API"](#).

### 9.4.1 How to Add a Servlet to the Grades Project

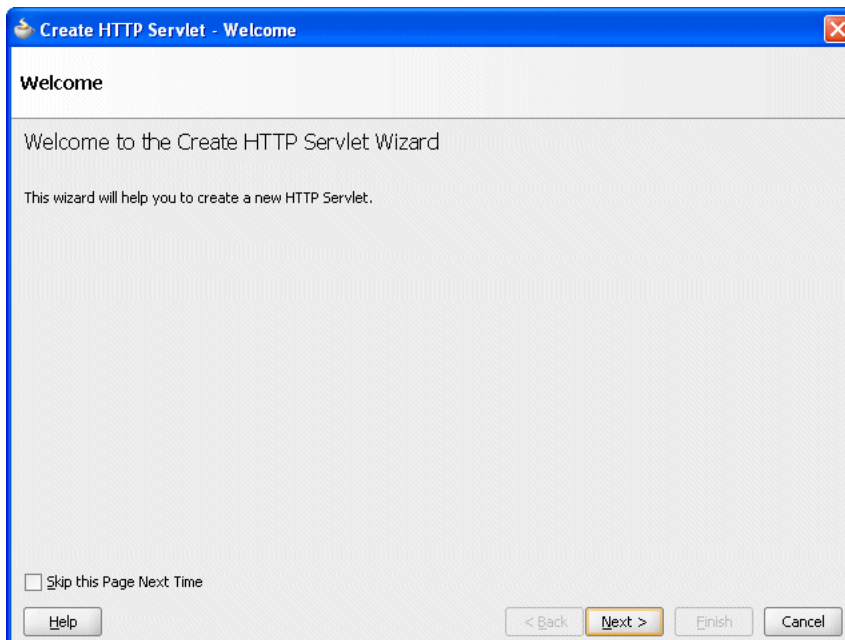
You add a servlet to the grades project using the Create HTTP Servlet wizard.

#### To add a servlet to the Grades project with Oracle JDeveloper:

1. In the Application Navigator, select the **Grades** project.
2. Right-click the **Grades** project and in the context menu select **New...**
3. In the New Gallery, select the **All Technologies** tab.
4. In the New Gallery, in the **Categories** area expand **Web Tier** and select **Servlets**.
5. In the New Gallery, in the **Items** area select **HTTP Servlet**.
6. Click **OK**.

Oracle JDeveloper displays the Create HTTP Servlet Welcome page, as shown in [Figure 9–15](#).

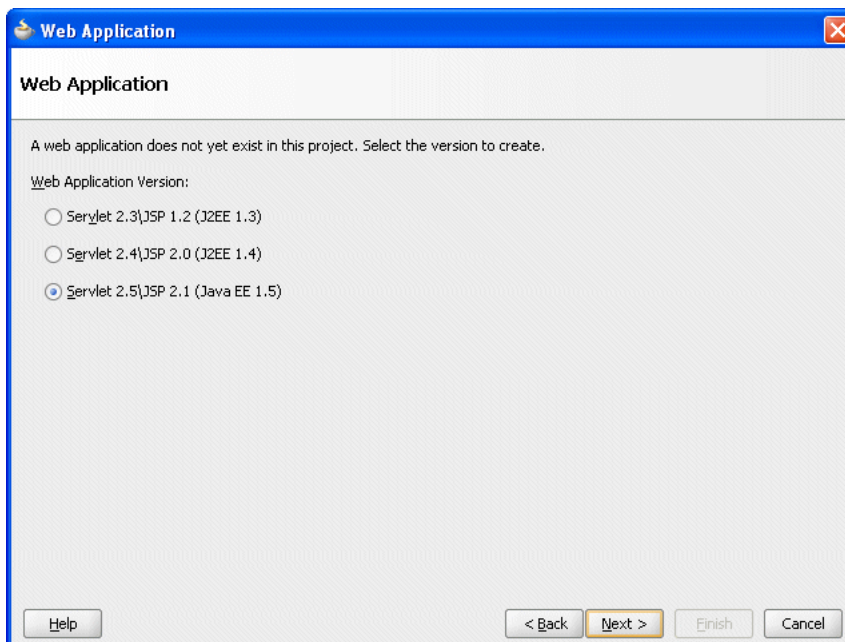
**Figure 9–15 Create HTTP Servlet Wizard - Welcome**



7. Click **Next**.

This displays the Web Application page, as shown in [Figure 9–16](#).

**Figure 9–16 Create HTTP Servlet Wizard - Web Application**



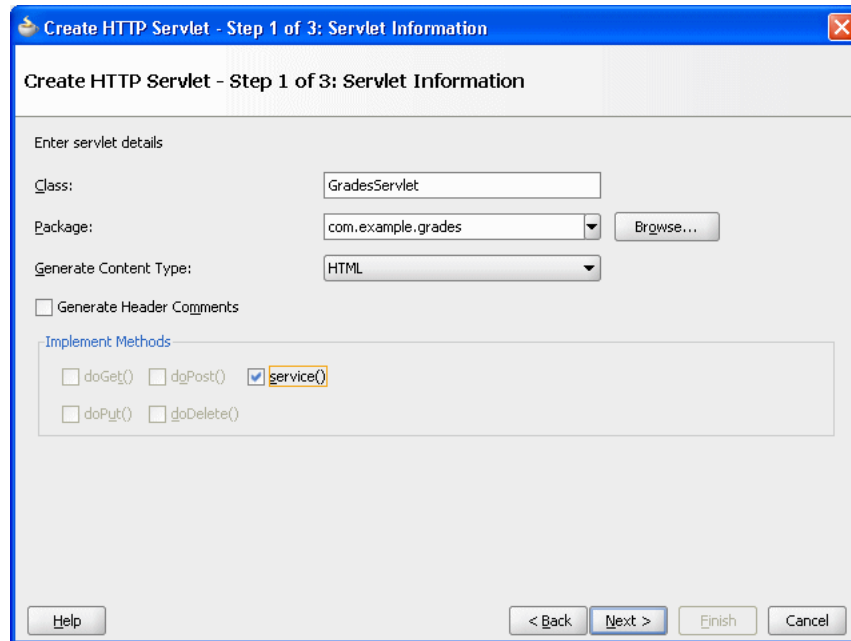
8. Select **Servlet 2.5\JSP 2.1 (Java EE 1.5)** and click **Next**.

This displays the Create HTTP Servlet - Step 1 of 3: Servlet Information page.

9. Enter values in Create HTTP Servlet - Step 1 of 3: Servlet Information page, as follows, and as shown in [Figure 9–17](#).

- **Class:** GradesServlet
- **Package:** com.example.grades
- **Generate Content Type:** HTML
- **Generate Header Comments:** unchecked
- **Implement Methods:** service() checked and all other checkboxes unchecked

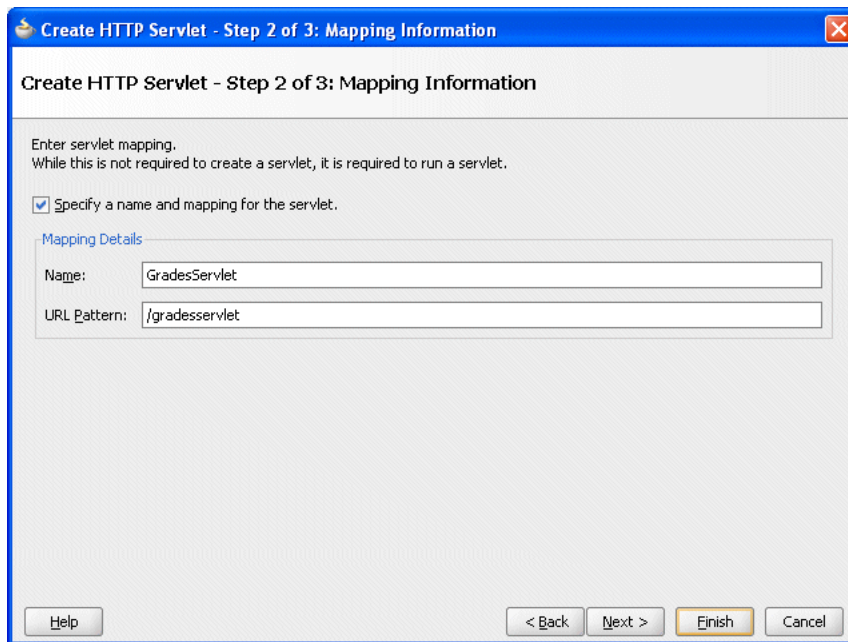
**Figure 9–17** Create HTTP Servlet Wizard - Step 1 of 3: Servlet Information



**10. Click Next.**

This displays the Create HTTP Servlet: Step 2 of 3: Mapping Information dialog as shown in [Figure 9–18](#).

**Figure 9–18 Create HTTP Servlet Wizard - Step 2 of 3: Mapping Information**

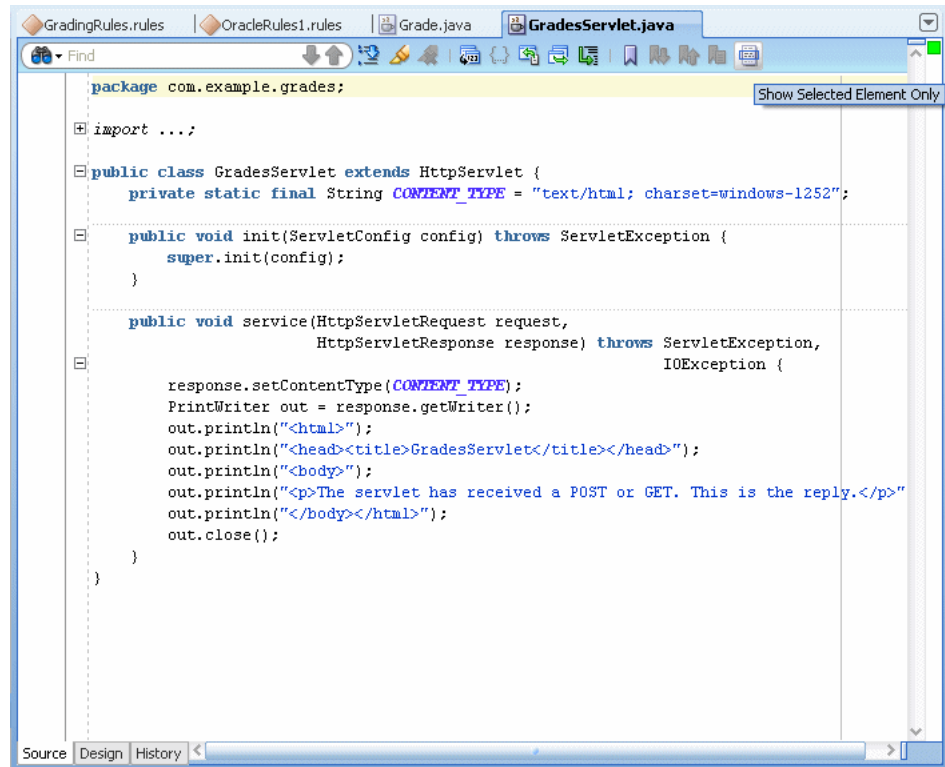


11. Configure this dialog as follows:

- **Name:** GradesServlet
- **URL Pattern:** /gradesservlet

12. Click **Finish**.

JDeveloper adds a Web Content folder to the project and creates a GradesServlet.java file and opens the file in the editor as shown in [Figure 9–19](#).

**Figure 9–19** Generated *GradesServlet.java*

13. Replace the generated servlet with the source shown in [Example 9–2](#).

### **Example 9–2** Business Rules Using Servlet for Grades Application

```

package com.example.grades;

import java.io.IOException;
import java.io.PrintWriter;

import java.util.ArrayList;
import java.util.List;

import javax.servlet.ServletConfig;
import javax.servlet.ServletException;
import javax.servlet.http.HttpServlet;
import javax.servlet.http.HttpServletRequest;
import javax.servlet.http.HttpServletResponse;

import oracle.rules.rl.exceptions.RLException;
import oracle.rules.sdk2.decisionpoint.DecisionPoint;
import oracle.rules.sdk2.decisionpoint.DecisionPointBuilder;
import oracle.rules.sdk2.decisionpoint.DecisionPointInstance;
import oracle.rules.sdk2.exception.SDKException;
import oracle.rules.sdk2.repository.DictionaryFQN;

public class GradesServlet extends HttpServlet {

    private static final String CONTENT_TYPE = "text/html";
    private static final String DICT_PKG = "com.example.grades";
    private static final String DICT_NAME = "GradingRules";
    private static final DictionaryFQN DICT_FQN =
        new DictionaryFQN(DICT_PKG, DICT_NAME);
    private static final String DF_NAME = "GradesDecisionFunction";

```

```

private DecisionPoint m_decisionPoint = null; // init in init()

public void init(ServletConfig config) throws ServletException {
    super.init(config);

    try {

        // specifying the Decision Function and Dictionary FQN
        // load the rules from the MDS repository.
        m_decisionPoint = new DecisionPointBuilder()
            .with(DF_NAME)
            .with(DICT_FQN)
            .build();
    } catch (SDKException e) {
        System.err.println("Failed to build Decision Point: " +
            e.getMessage());
        throw new ServletException(e);
    }
}

public void service(HttpServletRequest request,
                    HttpServletResponse response) throws ServletException,
                    IOException {

    // retrieve parameters
    String name = request.getParameter("name");
    String strScore = request.getParameter("testScore");

    // open output document
    StringBuilder doc = new StringBuilder();
    addHeader(doc);

    // create TestScore object to assert
    final TestScore testScore = new TestScore();
    testScore.setName(name);

    try {
        testScore.setTestScore(Integer.parseInt(strScore));
    } catch (NumberFormatException e) { /* use default val */ }

    // get DecisionPointInstance for invocation
    DecisionPointInstance point = m_decisionPoint.getInstance();

    // set input parameters
    point.setInputs(new ArrayList() {{ add(testScore); }});

    // invoke decision point and get result value
    TestGrade testGrade = null;
    try {

        // invoke the decision point with our inputs
        List<Object> result = point.invoke();
        if (result.size() != 1){
            error(doc, testScore.getName(), "bad result", null);
        }
        // decision function returns a single TestGrade object
        testGrade = (TestGrade)result.get(0);
    } catch (RLEException e) {
        error(doc, testScore.getName(), "RLEException occurred: ", e);
    } catch (SDKException e) {
        error(doc, testScore.getName(), "SDKException occurred", e);
    }
}

if (testGrade != null){
    // create output table in document
    openTable(doc);
    addRow(doc, testScore.getName(), strScore, testGrade.getGrade());
}

```

```

        closeTable(doc);
    }

    addFooter(doc);

    // write document
    response.setContentType(CONTENT_TYPE);
    PrintWriter out = response.getWriter();
    out.println(doc);
    out.close();
}

public static void addHeader(StringBuilder doc) {
    doc.append("<html>");
    doc.append("<head><title>GradesServlet</title></head>");
    doc.append("<body>");
    doc.append("<h1>Test Results</h1>");
}

public static void addFooter(StringBuilder doc) {
    doc.append("</body></html>");
}

public static void openTable(StringBuilder doc) {
    doc.append("<table border=\"1\"");
    doc.append("<tr>");
    doc.append("<th>Name</th>");
    doc.append("<th>Score</th>");
    doc.append("<th>Grade</th>");
    doc.append("</tr>");
}

public static void closeTable(StringBuilder doc) {
    doc.append("</table>");
}

public static void addRow(StringBuilder doc, String name, String score, Grade grade){
    doc.append("<tr>");
    doc.append("<td>"+ name + "</td>");
    doc.append("<td>"+ score + "</td>");
    doc.append("<td>"+ grade.value() + "</td>");
    doc.append("</tr>");
}

public static void error(StringBuilder doc, String name, String msg, Throwable t){
    doc.append("<tr>");
    doc.append("<td>"+ name + "</td>");
    doc.append("<td colspan=2>"+ msg + " " + t + "</td>");
    doc.append("</tr>");
}
}

```

[Example 9–2](#) includes a Oracle Business Rules Decision Point, that uses an MDS repository to access the dictionary. For more information, see [Section 7.5, "What You Need to Know About Using Decision Point in a Production Environment"](#).

When you add the Servlet shown in [Example 9–2](#), note the following:

- In the `init()` method the servlet uses the Rules SDK Decision Point API for Oracle Business Rules. For more information on using the Decision Point API, see [Chapter 7, "Working with Rules SDK Decision Point API"](#).
- The `DecisionPointBuilder()` requires arguments including a decision function name and, in a production environment a dictionary FQN to access a dictionary in an MDS repository, as shown:

```
m_decisionPoint = new DecisionPointBuilder()
    .with(DF_NAME)
    .with(DICT_FQN)
```

For more information on using the Decision Point API, see [Chapter 7, "Working with Rules SDK Decision Point API"](#).

## 9.5 Adding an HTML Test Page for Grades Sample Application

The Grades sample application includes an HTML test page that you use to invoke the servlet you created in [Section 9.4, "Adding a Servlet with Rules SDK Calls for Grades Sample Application"](#).

### 9.5.1 How to Add an HTML Test Page to the Grades Project

To add an HTML page to the servlet you use the Create HTML File wizard.

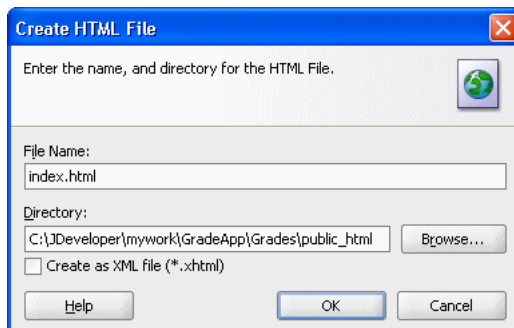
#### To add an HTML test page:

1. In the Application Navigator, in the **Grades** project select the **Web Content** folder.
2. Right-click the **Web Content** folder project and in the context menu select **New...**
3. In the New Gallery, select the **All Technologies** tab.
4. In the New Gallery, in the **Categories** area expand **Web Tier** and select **HTML**.
5. In the New Gallery, in the **Items** area select **HTML Page**.
6. In the New Gallery click **OK**.

Oracle JDeveloper displays the Create HTML File dialog.

7. Configure this dialog as follows and as shown in [Figure 9–20](#):
  - **File Name:** index.html
  - **Directory:** C:\JDeveloper\mywork\GradeApp\Grades\public\_html

**Figure 9–20** Create HTML File Dialog



8. Click **OK**.
 

JDeveloper adds index.html to the Web Content folder and opens the editor.
9. In the editor for index.html, select the **Source** tab.
10. Copy and paste the HTML code from [Example 9–3](#) to replace the contents of the index.html file.



Note that in the form element action attribute uses the URL Pattern you specified in [Figure 9–18](#).

### Example 9–3 HTML Test Page

```
<!DOCTYPE HTML PUBLIC "-//W3C//DTD HTML 4.01 Transitional//EN"
"http://www.w3.org/TR/html4/loose.dtd">
<html>
<head>
  <meta http-equiv="Content-Type" content="text/html; charset=windows-1252"></meta>
  <title>Test Grade Example Servlet</title>
</head>
<body>
  <form name="names_and_scores"
    method="post"
    action="/grades/gradesservlet" >
    <p>Name: <input type="text" name="name" /></p>
    <p>Test Score: <input type="text" name="testScore"/></p>
    <input type="submit" value="Submit">
  </form>
</body>
</html>
```

11. Select **Save All** from the **File** main menu to save your work.

## 9.6 Preparing the Grades Sample Application for Deployment

Business rules are deployed as part of the application for which you create a deployment profile in Oracle JDeveloper. You deploy the application to Oracle WebLogic Server.

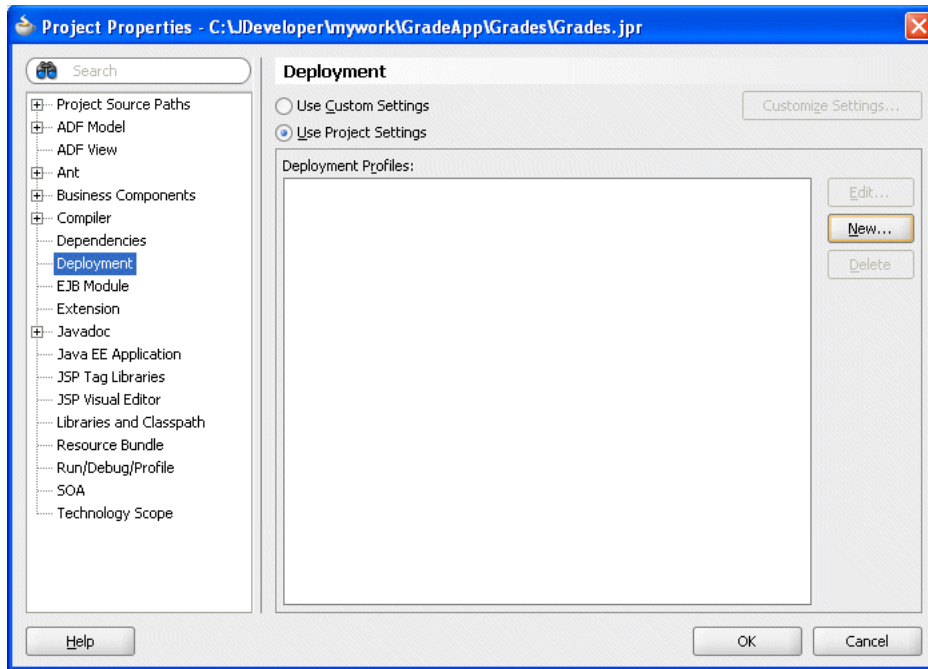
### 9.6.1 How to Create the WAR File for the Grades Sample Application

You deploy the GradeApp sample application using JDeveloper with Oracle WebLogic Server.

**To create the WAR file for the grades sample application:**

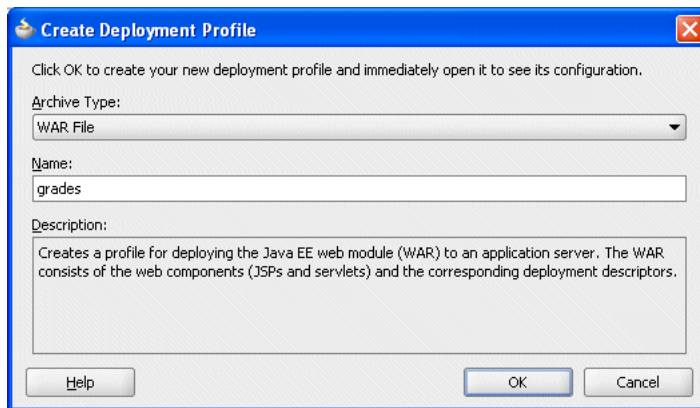
1. In the Application Navigator, select the **Grades** project.
2. Right-click the **Grades** project and in the context menu select **Project Properties...**. This displays the Project Properties dialog for the project.
3. In the Project Properties navigator, select the **Deployment** item as shown in [Figure 9–21](#).

**Figure 9–21 Project Properties - Deployment**



4. In the Project Properties dialog, click **New...**  
This displays the Create Deployment Profile dialog.
5. In the Create Deployment Profile dialog, in the **Archive Type** list, select **WAR File**.
6. In the Create Deployment Profile dialog, in the **Name** field enter **grades**, as shown in [Figure 9–22](#). Note the **Name** value uses the package value that you specified in the form element `action` attribute in [Example 9–3](#).

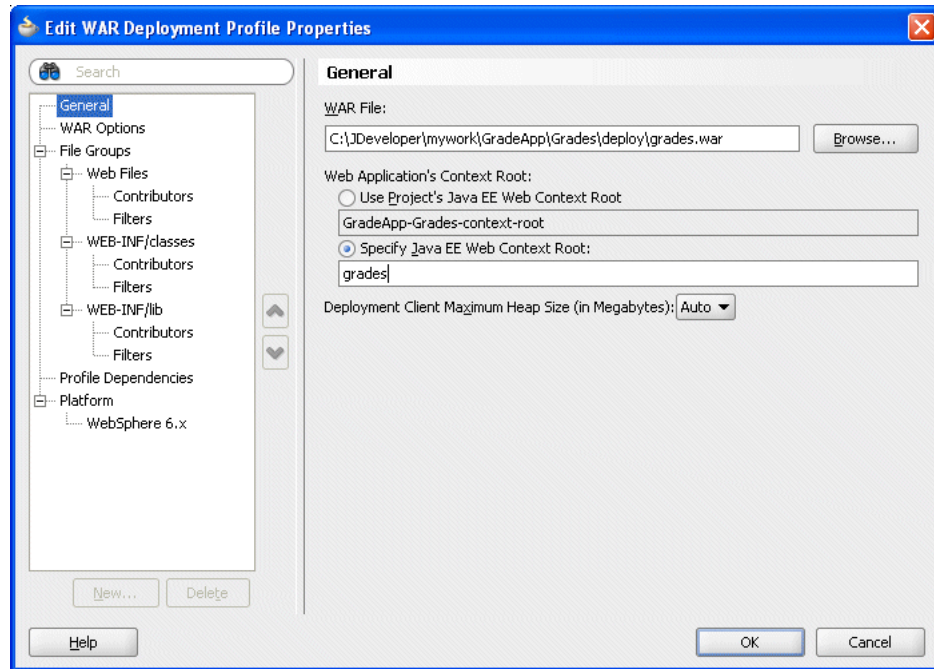
**Figure 9–22 Create Deployment Profile Dialog for WAR File**



7. Click **OK**.  
This displays the Edit WAR Deployment Profile Properties dialog.
8. In the Edit War Deployment Profile Properties dialog, select **General** and configure the General page as follows, as shown in [Figure 9–23](#):
  - a. Set the **WAR File**:  
C:\JDeveloper\mywork\GradeApp\Grades\deploy\grades.war

- b. In the **Web Application Context Root** area, select **Specify Java EE Web Context Root**:
- c. In the **Specify Java EE Web Context Root**: text entry area, enter `grades`.
- d. In the **Deployment Client Maximum Heap Size (in Megabytes)**: list select **Auto**

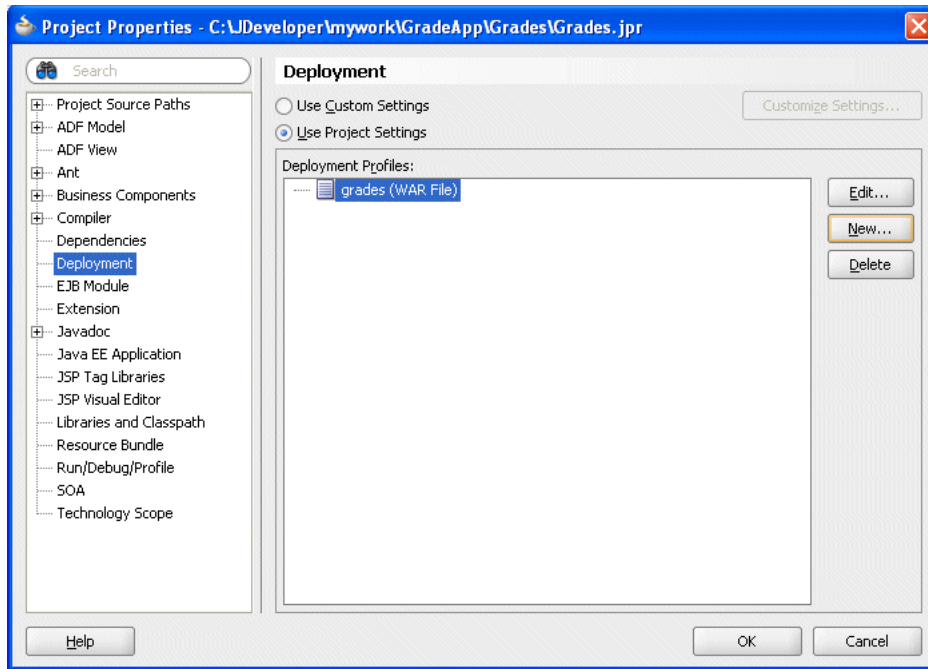
**Figure 9–23 Edit WAR Deployment Properties - General**



9. In the Edit WAR Deployment Profile Properties dialog, click **OK**.

JDeveloper creates a deployment profile named `grades` (WAR File) as shown in [Figure 9–24](#).

**Figure 9–24 Project Properties - Deployment Profile Created**



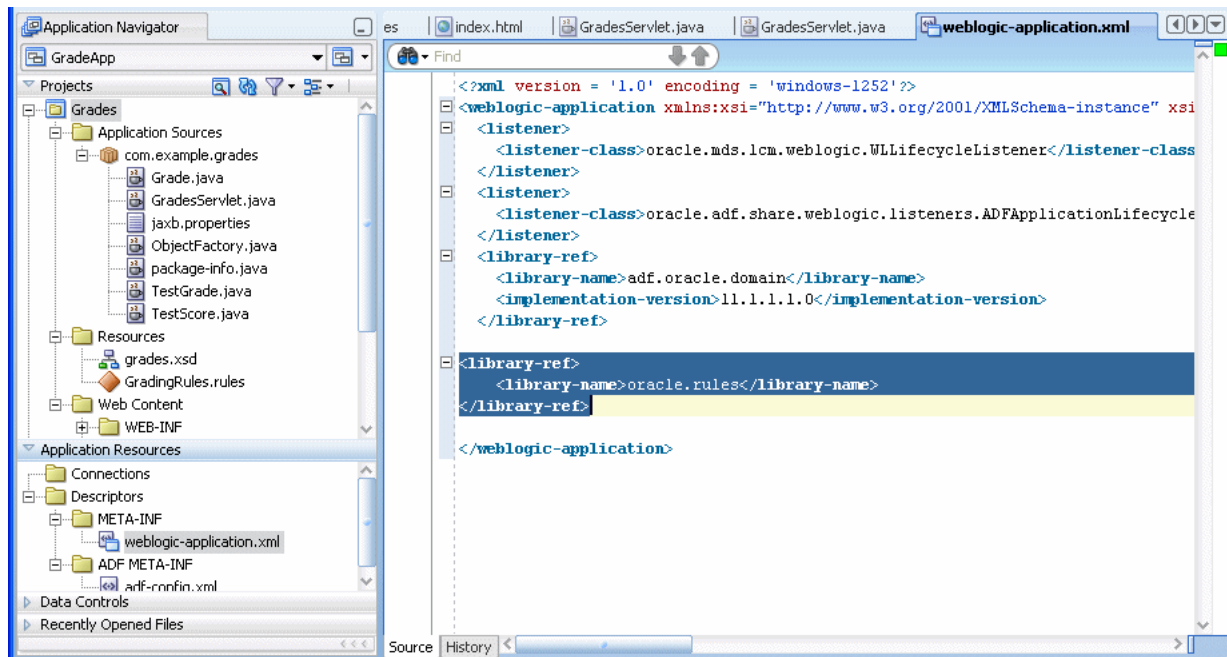
10. In the Project Properties dialog, click **OK**.

## 9.6.2 How to Add the Rules Library to the Grades Sample Application

**To add the rules library to the weblogic-application file:**

1. In the GradeApp application, in the Application Navigator expand **Application Resources**.
2. Expand **Descriptors** and expand **META-INF** and double-click to open **weblogic-application.xml**.
3. Add the `oracle.rules` library reference to the `weblogic-application.xml` file. Add the following lines, as shown in [Figure 9–25](#).

```
<library-ref>
  <library-name>oracle.rules</library-name>
</library-ref>
```

**Figure 9–25 Adding Oracle Rules Library Reference to WebLogic Descriptor**

4. Save the weblogic-application.xml file.

### 9.6.3 How to Add the MDS Deployment File to the Grades Sample Application

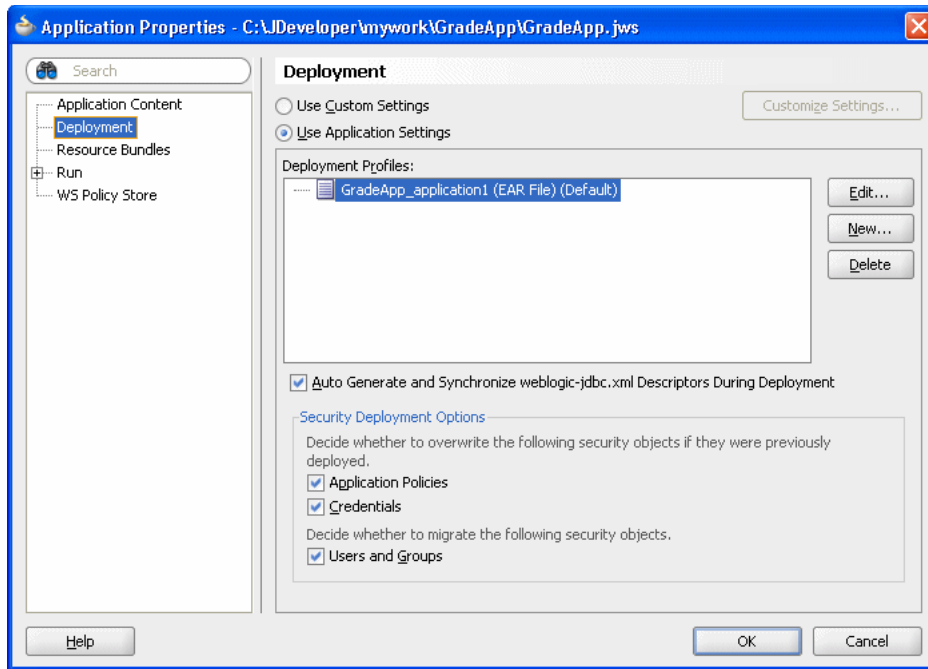
#### To add the MDS deployment file:

1. In the Application Navigator, select the **GradeApp** application.
2. Right-click the **GradeApp** application and in the context menu select **Application Properties...**

This displays the Application Properties dialog.

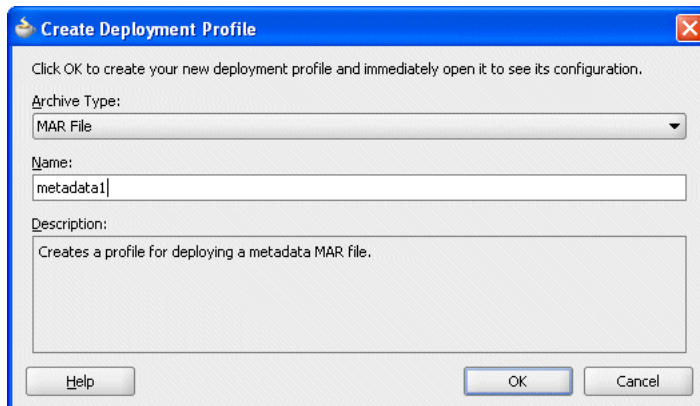
3. In the Application Properties navigator select the **Deployment** item, as shown in [Figure 9–26](#).

**Figure 9–26 Application Properties - Deployment**

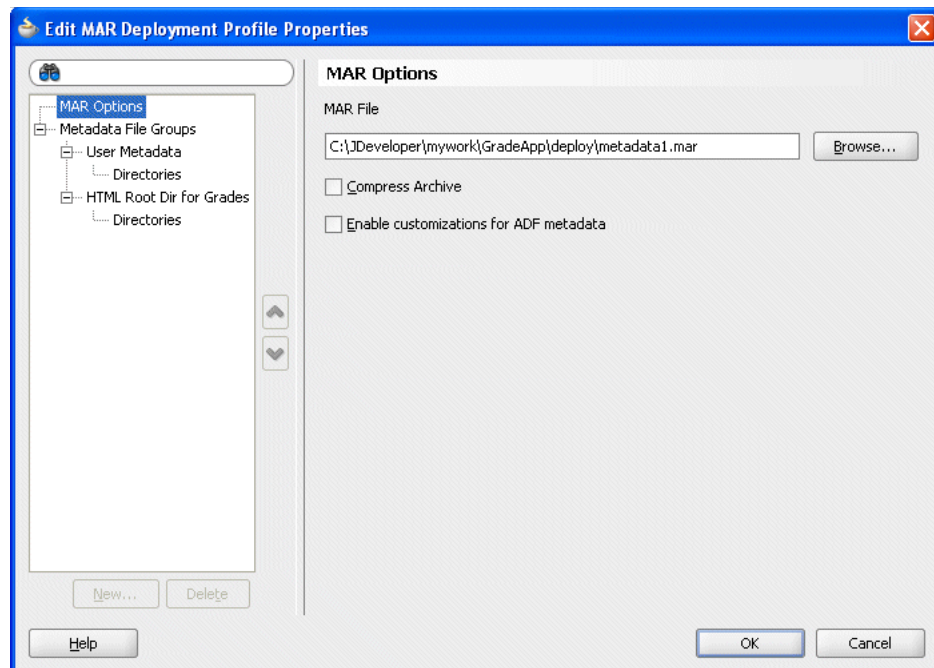


4. In the Application Properties dialog, click **New...**  
This displays the Create Deployment Profile dialog.
5. Configure this dialog as follows, as shown in [Figure 9–27](#):
  - **Archive Type:** MAR File
  - **Name:** metadata1

**Figure 9–27 Create Deployment Profile Dialog for MAR File**

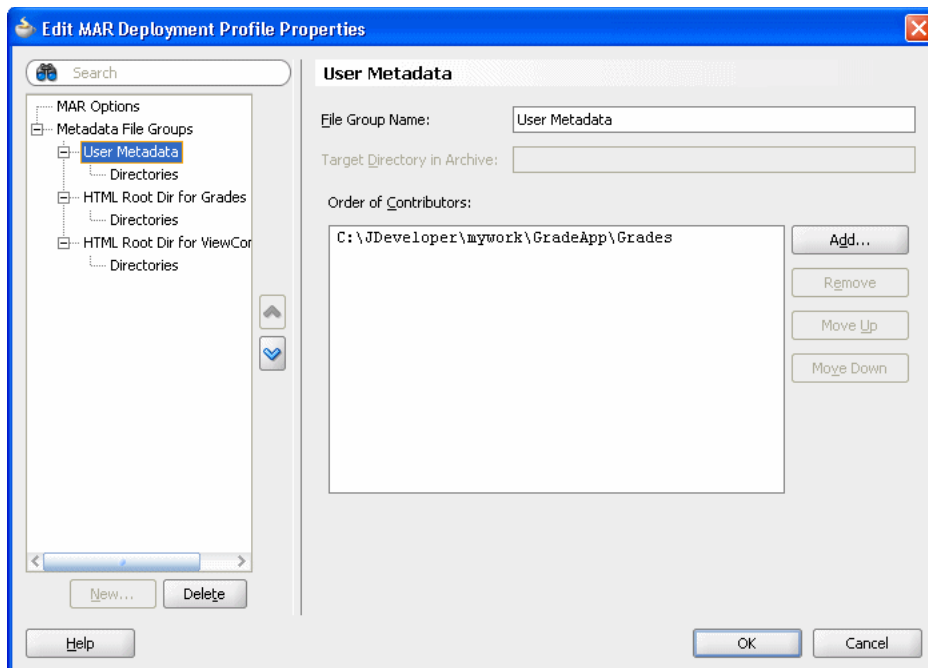


6. Click **OK**.  
This displays the Edit MAR Deployment Properties dialog as shown in [Figure 9–28](#).

**Figure 9–28 Edit MAR Deployment Profile Properties - MAR Options**

7. Expand the **Metadata File Groups** item and select the **User Metadata** item.
8. Click **Add...**  
This displays the Add Contributor dialog.
9. In the Add Contributor dialog, click the **Browse** button and navigate to the directory for the project that contains the `GradingRules.rules` dictionary file.  
In this example, navigate to `C:\JDeveloper\mywork\GradeApp\Grades` and click **Select**.
10. In the Add Contributor dialog, click **OK** to close the dialog. This displays the Edit MAR Deployment Properties dialog as shown in [Figure 9–29](#)

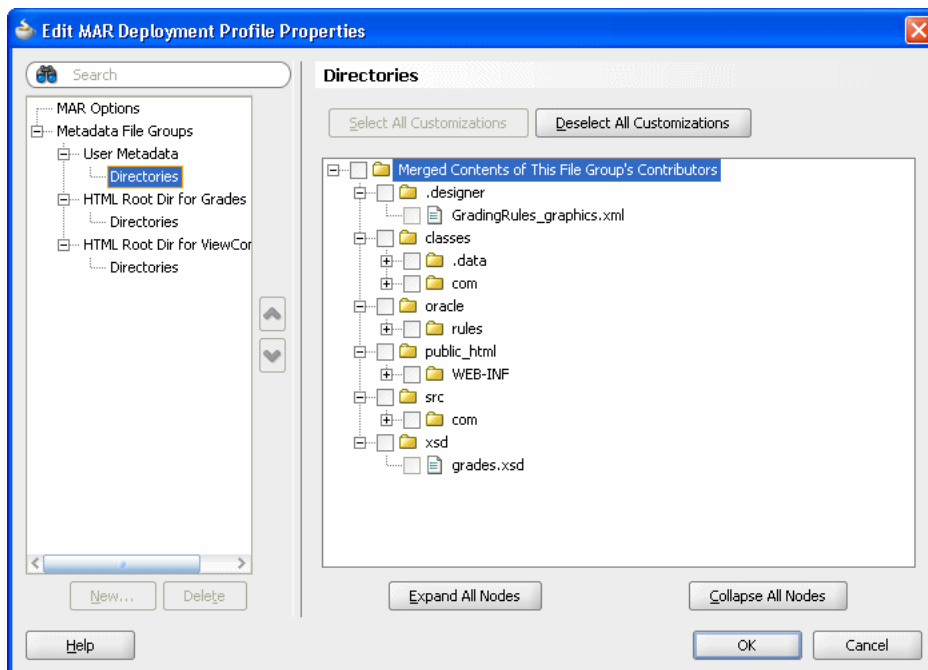
**Figure 9–29 Edit MAR Deployment Profile Properties - User Metadata**



11. In the Edit MAR Deployment Profile Properties dialog, expand the **Metadata File Groups** and expand the **User Metadata** item and select **Directories**.

This displays the Directories page as shown in [Figure 9–30](#).

**Figure 9–30 Edit MAR Deployment Profile Properties - Directories**

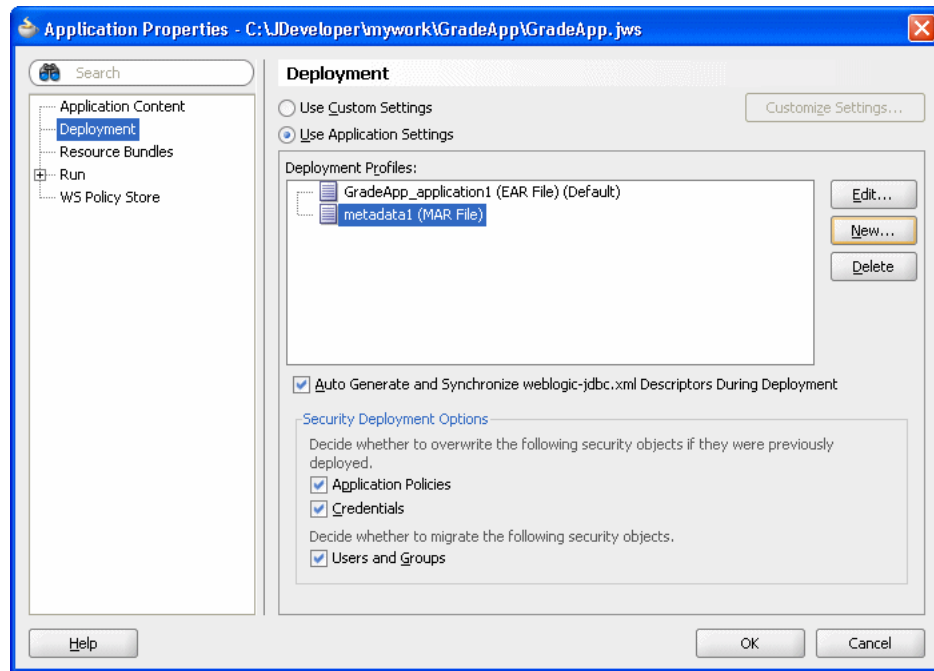


12. Select the **oracle** directory checkbox. This selects the **GradingRules.rules** dictionary to be included in the MAR.
13. Click **OK**.



JDeveloper creates an application deployment profile named `metadata1` (MAR File) as shown in [Figure 9–31](#).

**Figure 9–31 Application Properties - Deployment - MAR**



14. In the Application Properties dialog, click **OK**.

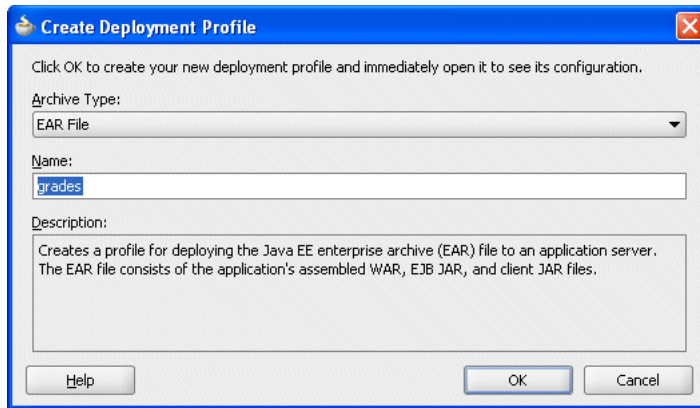
## 9.6.4 How to Add the EAR File to the Grades Sample Application

Add an EAR file to the Grades sample application.

**To add the ear file to the grades sample application:**

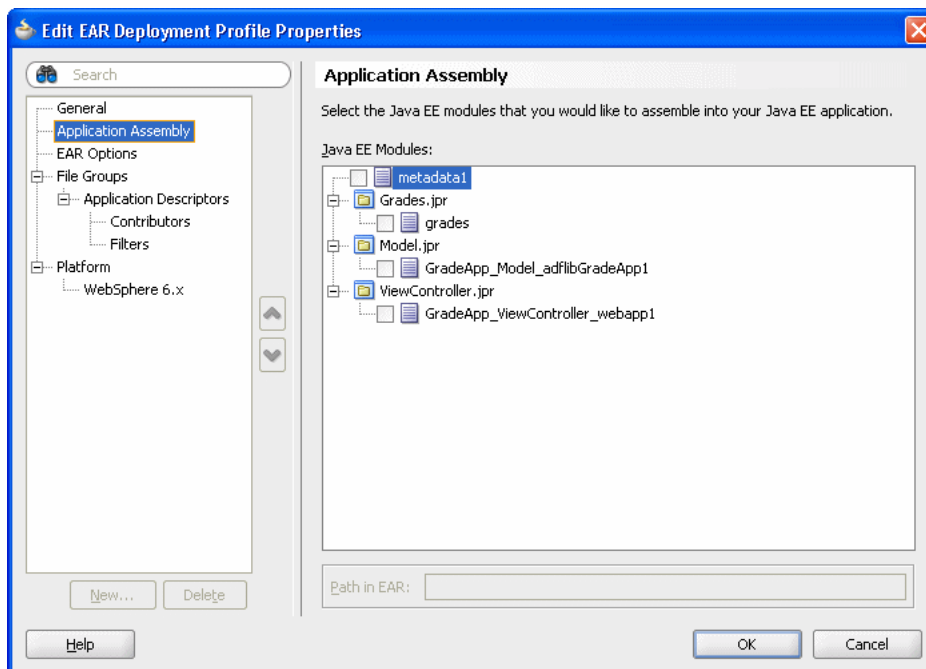
1. In the Application Navigator, select the **GradeApp** application.
2. Right-click and in the context menu select **Application Properties...**
3. In the Application Properties dialog, select **Deployment** and click **New...** This displays the Create Deployment Profile dialog.
4. Configure this dialog as follows, as shown in [Figure 9–32](#).
  - **Archive Type:** EAR
  - **Name:** grades

**Figure 9–32 Create Deployment Profile Dialog for EAR File**



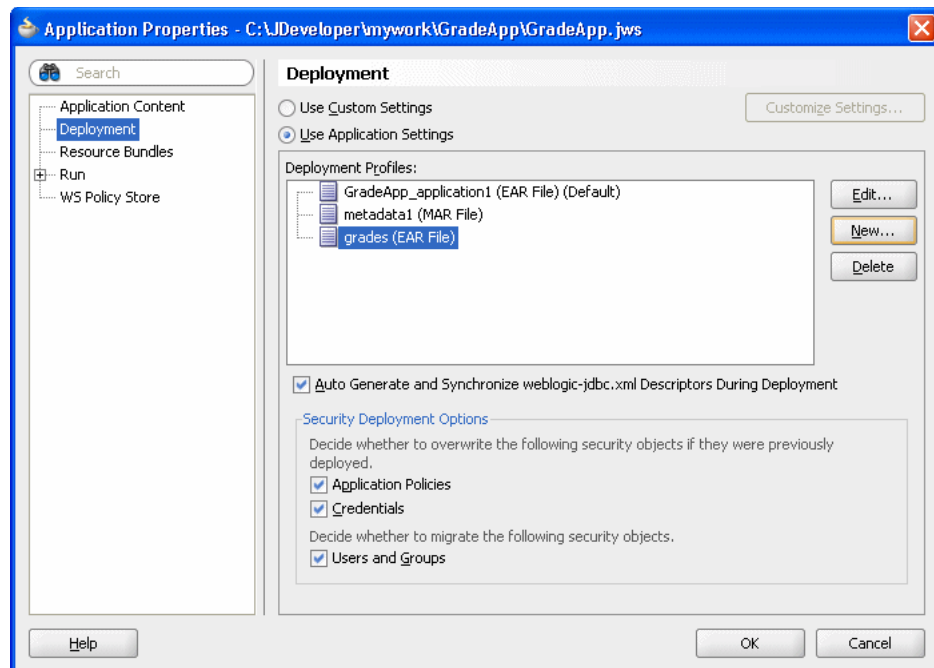
5. Click **OK**. This displays the Edit EAR Deployment Profile Properties dialog.
6. In the Edit Ear Deployment Profile Properties dialog, in the navigator select **Application Assembly** as shown in [Figure 9–33](#).

**Figure 9–33 Edit EAR Deployment Profile Properties - Application Assembly**



7. Configure this dialog as follows:
  - Select the **metadata1** checkbox.
  - Expand the **Grades.jpr** item and select the **grades** checkbox.
8. In the Edit EAR Deployment Profile Properties dialog, click **OK**.

JDeveloper creates an application deployment profile named `grades` (EAR File) as shown in [Figure 9–34](#).

**Figure 9–34 Application Properties - Deployment - EAR**

9. Click **OK** to close the Application Properties dialog.
10. Select **Save All** from the **File** main menu to save your work.

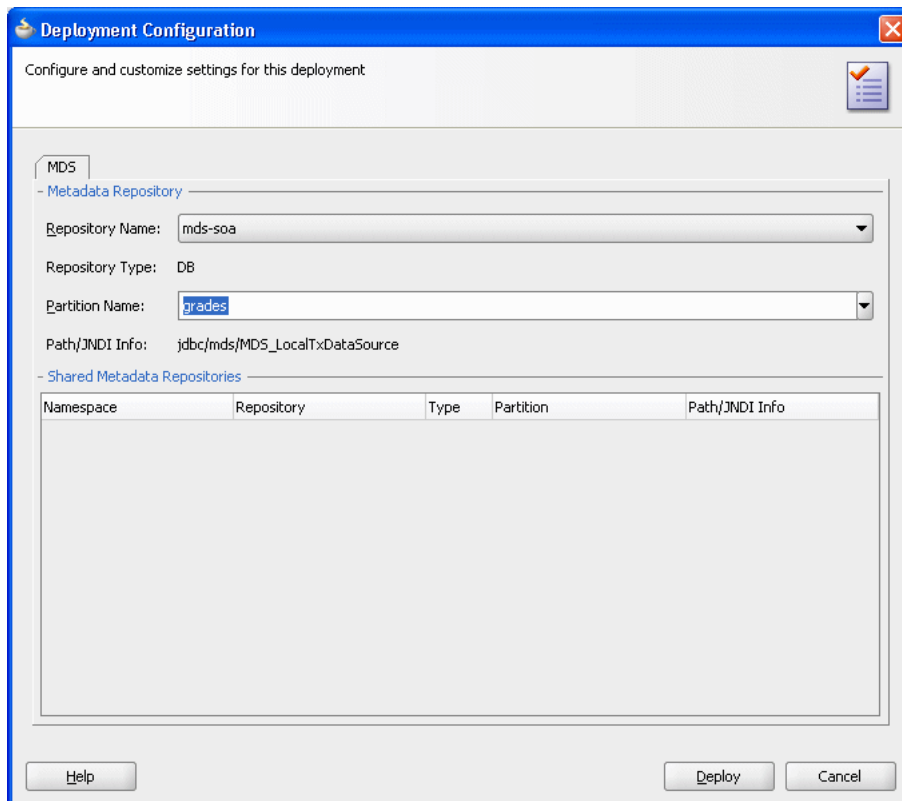
## 9.7 Deploying and Running the Grades Sample Application

You can now deploy and run the grades sample application on Oracle WebLogic Server.

### 9.7.1 How to Deploy to Grades Sample Application

#### To deploy the grades sample application:

1. In the Application Navigator, select the GradeApp application.
2. Right-click the **GradeApp** application and in the context menu select **Deploy > grades > to >** and select either an existing connection or **New Connection...** to create a connection for the deployment. This starts the deployment to the specified Oracle WebLogic Server.
3. As the deployment proceeds, Oracle JDeveloper shows the Deployment Configuration dialog.
4. In the Deployment Configuration dialog enter the following values, as shown in [Figure 9–32](#):
  - In the **Repository Name** field, from the list, select: **mds-soa**
  - In the **Partition Name** field, enter **grades**

**Figure 9–35 Deployment Configuration Dialog for MDS with Repository and Partition**

5. In the Deployment Configuration dialog, click **Deploy**.

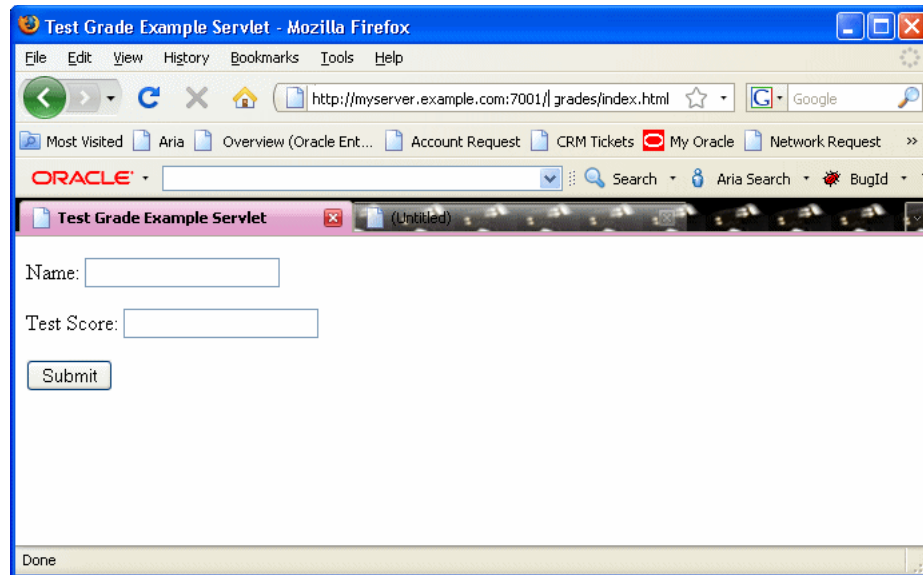
## 9.7.2 How to Run the Grades Sample Application

After you deploy the grades sample application, you can run the application.

### To run the grades sample application:

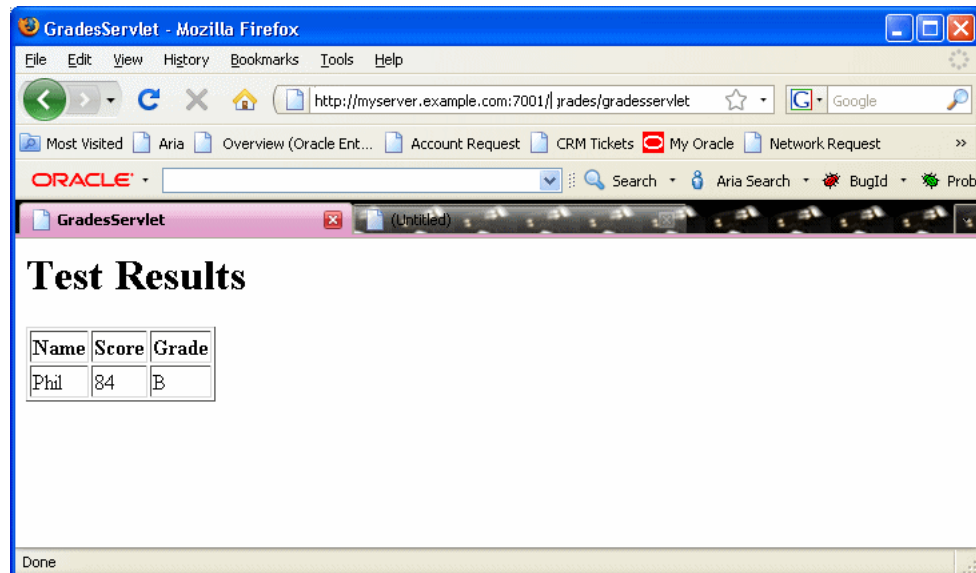
1. Point a web browser at,  
<http://yourServerName:port/grades/>

This displays the test servlet as shown in [Figure 9–36](#).

**Figure 9–36 Grades Sample Application Servlet**

2. Enter a name and test score and click **Submit**. This returns results as shown in [Figure 9–37](#).

The first time you run the servlet there may be a delay before any results are returned. The first time the servlet is invoked, during servlet initialization the runtime loads the dictionary and creates a rule session pool. Subsequent invocations do not perform these steps and should run much faster.

**Figure 9–37 Grades Sample Application Servlet with Results**



---

---

## Working with Oracle Business Rules and ADF Business Components

This chapter describes how Oracle Business Rules allows you to use Oracle ADF Business Components view objects as facts to assert trees of view object graphs representing the business objects upon which rules should be based, and let Oracle Business Rules handle the complexities of managing the relationships between the various related view objects in the main view object's tree.

The chapter includes the following sections:

- [Section 10.1, "Introduction to Using Business Rules with ADF Business Components"](#)
- [Section 10.2, "Using Decision Points with ADF Business Components Facts"](#)
- [Section 10.3, "Creating a Business Rules Application with ADF Business Components Facts"](#)

### 10.1 Introduction to Using Business Rules with ADF Business Components

The ADF Business Components rule development process can be summarized as follows:

1. Create view object definitions.
2. Create action types.
3. Create rule dictionary.
4. Register view object fact types.
5. Register Java fact types for actions.
6. If you are invoking from Java:
  - If the view object is already instantiated at the Decision Point, code the Decision Point invocation passing the view object instance.
  - If the view object is not instantiated at the Decision Point, code the Decision Point invocation passing the view object key values.

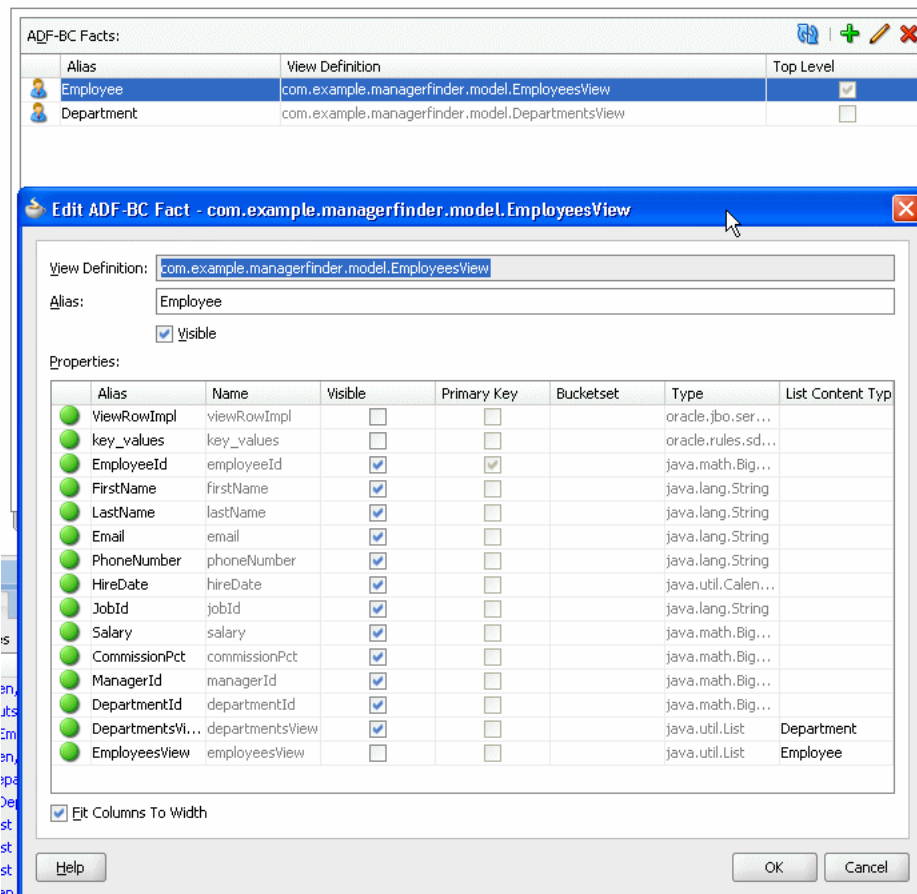
#### 10.1.1 Understanding Oracle Business Rules ADF Business Components Fact Types

When an ADF Business Components view object is imported into an Oracle Business Rules data model, an ADF Business Components fact type is created which has a property corresponding to each attribute of the view object, as shown in [Figure 10–1](#).

Additionally, the ADF Business Components fact type contains the following:

- A property named **ViewRowImpl** which points directly to the `oracle.jbo.Row` instance that each fact instance represents.
- A property named **key\_values** which points to an `oracle.rules.sdk2.decisionpoint.KeyChain` object. You can use this property to retrieve the set of key-values for this row and its parent rows.

**Figure 10–1 ADF Business Components Sample Fact Type**



Note the following:

- Relationships between view object definitions are determined by introspection of attributes on the View Definition, specifically, those attributes which are View Link Accessors.

The ADF Business Components fact type importer correctly determines which relationships are 1-to-1 and which are 1-to-many and generates definitions in the dictionary accordingly. For 1-to-many relationships the type of the property generated is a `List` which contains facts of the indicated type at runtime.

- ADF Business Components fact types are not Java fact types and do not allow invoking methods on any explicitly created implementation classes for the view object.

If you need to call such methods then add the view object implementation to the dictionary as a Java fact type instead of as an ADF Business Components fact type. In this case, all getters and setters and other methods become available but the



trade-off is that related view objects become inaccessible and, should related view object access be required, these relationships must be explicitly managed.

- Internally in Oracle Business Rules, when you use ADF Business Components fact types these fact types are created as instances of RL fact types. Thus, you cannot assert ADF Business Components view object instances directly to a Rule Session, but must instead use the helper methods provided in the `MetadataHelper` and `ADFBCFactTypeHelper` classes. For more information, see *Oracle Fusion Middleware Java API Reference for Oracle Business Rules*.

## 10.1.2 Understanding Oracle Business Rules Decision Point Action Type

With Rules SDK, the primary way to update a view object within a Decision Point is with an action type. An action type is a Java class that you import into the rule dictionary data model in the same way you import a rule pattern fact type Java class. A new instance of this action type is then asserted in the action of a rule and then processed by the Postprocessing Ruleset in the `DecisionPointDictionary`.

A Java class to be used as an action type must conform to the following requirements:

- The Java fact type class must subclass `oracle.rules.sdk2.decisionpoint.ActionType` or `oracle.rules.sdk2.decisionpoint.KeyedActionType`.  
By subclassing `KeyedActionType` the Java class inherits a standard `oracle.rules.sdk2.decisionpoint.KeyChain` attribute, which may be used to communicate the rule fact's primary keys and parent-keys to the `ActionType` instance.
- The class has a default constructor.
- The class implements abstract `exec` method for the `ActionType`. The `exec` method should contain the main action which you want to perform.
- The Java class must have properties which conform to the `JavaBean` interface (that is, each property must have a getter and setter method).

[Example 10–1](#) shows a sample `ActionType` implementation.

### Example 10–1 Implementing an ActionType

```
package com.example;

import oracle.jbo.domain.Number;

import oracle.rules.sdk2.decisionpoint.ActionType;
import oracle.rules.sdk2.decisionpoint.DecisionPointInstance;

public class RaiseAction extends ActionType {
    private double raisePercent;

    public void exec(DecisionPointInstance dpi) {
        Number salary = (Number)getViewRowImpl().getAttribute("Salary");
        salary = (Number)salary.multiply(1.0d + getRaisePercent()).scale(100,2, new
boolean[] {false});
        dpi.addResult("raise for " + this.getViewRowImpl().getAttribute("EmployeeId"),
            getRaisePercent() + "=>" + salary );
        getViewRowImpl().setAttribute("Salary", salary);
    }

    public void setRaisePercent(double raisePercent) {
        this.raisePercent = raisePercent;
    }
}
```

```

    public double getRaisePercent() {
        return raisePercent;
    }
}

```

In [Example 10–1](#), there is an `oracle.rules.sdk2.decisionpoint.DecisionPointInstance` as a parameter to the `exec` method. [Table 10–1](#) shows the methods in `DecisionPointInstance` that an application developer might need when implementing the `ActionType` `exec`.

**Table 10–1** *DecisionPointInstance Methods*

Method	Description
<code>getProperties</code>	Supplies a <code>HashMap&lt;String, Object&gt;</code> object containing any runtime-specified parameters that the action types may need. If you intend to use the decision function from a Decision service, use only <code>String</code> values.
<code>getRuleSession</code>	Gives access to the Oracle Business Rules <code>RuleSession</code> object from which static configuration variables in the Rule Dictionary may be accessed.
<code>getActivationID</code>	If populated by the caller, supplies a <code>String</code> value to be used for Set Control indirection.
<code>getTransaction</code>	Provides a transaction object so that action types may make persistent changes in the back end.
<code>addResult</code>	Adds a named result to the list of output values in the form of a <code>String</code> key and <code>Object</code> value. Output is assembled as a <code>List</code> of <code>oracle.rules.sdk2.decisionpoint.DecisionPointInstance.NamedValue</code> objects as would be the case in a pure map implementation. The <code>NamedValue</code> objects are simple data-bearing classes with a getter each for the name and value. Output values from one action types instance are never allowed to overwrite each other, and in this regard, the action type implementations should be considered completely independent of each other.

Using Rules Designer you can select parameters appropriate for the `ActionType` you are configuring.

## 10.2 Using Decision Points with ADF Business Components Facts

You can use a Decision Point to execute a decision function. There are certain Decision Point methods that only apply when working with ADF Business Components Fact types. For more information on decision functions, see [Chapter 6, "Working with Decision Functions"](#).

### 10.2.1 How to Call a Decision Point with ADF Business Components Facts

When you use ADF Business Components fact types you invoke a decision function using the Rules SDK Decision Point interface.

**To call a decision function using the Rules SDK Decision Point interface:**

1. Construct and configure the template `DecisionPoint` instance using the `DecisionPointBuilder`.  
For more information, see [Section 7.3.1, "How to Add a Decision Point Using Decision Point Builder"](#).
2. Create a `DecisionPointInstance` using the `DecisionPoint` method `getInstance`.

3. Add the fact objects you want to use to the `DecisionPointInstance` using `DecisionPointInstance` method `addInput`, `setInputs`, or `setViewObject`. These are either `ViewObject` or `ViewObjectReference` instances. These must be added in the same order as they are declared in the decision function input. For more information, see [Section 10.2.1.3, "Calling the Invoke Method for an ADF Business Components Rule"](#)
4. Set the transaction to be used by the `DecisionPointInstance`.  
For more information, see [Section 10.2.1.1, "Setting the Decision Point Transaction"](#).
5. Set any runtime properties the consequent application actions may expect.  
For more information, see [Section 10.2.1.2, "Setting Runtime Properties"](#).
6. Call the `DecisionPointInstance` method `invoke`.  
For more information, see:
  - [Section 10.2.1.3, "Calling the Invoke Method for an ADF Business Components Rule"](#)
  - [Section 10.2.1.4, "What You Need to Know About Decision Point Invocation"](#)

### 10.2.1.1 Setting the Decision Point Transaction

The Oracle Business Rules SDK framework requires an `oracle.jbo.server.DBTransactionImpl2` instance to load a `ViewObject` and to provide `ActionType` instances within a transactional context. The class `oracle.jbo.server.DBTransactionImpl2` is the default JBO transaction object returned by calling the `ApplicationModule` method `getTransaction`. Setting the transaction requires calling the `DecisionPointInstance` method `setTransaction` with the `Transaction` object as a parameter.

Should a `DBTransaction` instance not be available for some reason, the Oracle Business Rules SDK framework can bootstrap one using any of the three provided overrides of the `setTransaction` method.

These require one of:

- A JDBC URL, user name, and password.
- A JDBC connection object.
- A `javax.sql.DataSource` object and a flag to specify whether the `DataSource` represents a JTA transaction or a local transaction.

### 10.2.1.2 Setting Runtime Properties

Runtime properties may be provided with the `setProperty` method. These can then be retrieved by `ActionType` instances during their execution. If no runtime properties are needed, you may safely omit these calls.

### 10.2.1.3 Calling the Invoke Method for an ADF Business Components Rule

The `ViewObject` to be used in a Decision Point invocation can be specified in one of two ways, as shown in [Table 10-2](#).

**Table 10–2 Setting the View Object for a Decision Point Invocation**

<b>ViewObject Set Method</b>	<b>Description</b>
setViewObject	<p>The decision function is invoked once for each ViewObject row. This is the preferred way to use view objects. Between each invocation of the decision function, the rule session is not reset so any asserted facts from previous invocations of the decision function are still in working memory. In most cases, users should write rules that retract the asserted facts before the decision function call completes. For example, you can have a cleanup ruleset that retracts the ViewObject row that runs before the Postprocessing decision function is called.</p> <p><a href="#">Section 10.3.9.3, "How to Add Retract Employees Ruleset"</a> shows this usage. To use setViewObject, the ViewObject must be the first entry in the decision function InputTable.</p>
addInput setInputs	<p>The decision function is invoked once with all of the ViewObject rows loaded at the same time. This is generally not a scalable operation, since hundreds of thousands of rows can be loaded at the same time. There are some cases where there are a known small number of rows in a ViewObject that this method of calling the ViewObject can be useful.</p>

[Example 10–2](#) shows how to invoke a Decision Point with a ViewObject instance using the setInputs method. For the complete example, see [Example 10–5](#).

**Example 10–2 Invoking a Decision Point Using setInputs Method**

```
public class OutsideManagerFinder {
    private static final String AM_DEF = "com.example.AppModule";
    private static final String CONFIG = "AppModuleLocal";
    private static final String VO_NAME = "EmployeesView1";

    private static final DictionaryFQN DICT_FQN =
        new DictionaryFQN("com.example", "Chapter10Rules");

    private static final String DF_NAME = "FindOutsideManagers";

    private DecisionPoint dp = null;

    public OutsideManagerFinder() {
        try {
            dp = new DecisionPointBuilder()
                .with(DICT_FQN)
                .with(DF_NAME)
                .build();
        } catch (SDKException e) {
            System.err.println(e);
        }
    }

    public void run() {
        final ApplicationModule am =
            Configuration.createRootApplicationModule(AM_DEF, CONFIG);
        final ViewObject vo = am.findViewObject(VO_NAME);
        final DecisionPointInstance point = dp.getInstance();
        point.setTransaction((DBTransactionImpl2)am.getTransaction());
        point.setAutoCommit(true);
        point.setInputs(new ArrayList<Object>(){ add(vo); });
        try {
            List<Object> invokeList = point.invoke();
        }
    }
}
```

```

List<DecisionPoint.NamedValue> results = point.getResults();
    } catch (RLEException e) {
        System.err.println(e);
    } catch (SDKException e) {
        System.err.println(e);
    }
}

```

[Example 10-3](#) shows how to invoke a DecisionPoint using the `setViewObject` method to set the ViewObject.

### **Example 10-3 Invoking a Decision Point Using `setViewObject` Method**

```

public void run() {
    final ApplicationModule am =
        Configuration.createRootApplicationModule(AM_DEF, CONFIG);
    final ViewObject vo = am.findViewObject(VO_NAME);
    final DecisionPointInstance point = dp.getInstance();

    point.setTransaction((DBTransactionImpl2)am.getTransaction());
    point.setAutoCommit(true);
    point.setViewObject(vo);
    try {
        List<Object> invokeList = point.invoke();
List<DecisionPoint.NamedValue> results = point.getResults();
        } catch (RLEException e) {
            System.err.println(e);
        } catch (SDKException e) {
            System.err.println(e);
        }
    }
}

```

#### **10.2.1.4 What You Need to Know About Decision Point Invocation**

Care must be taken when invoking Decision Points using a view object that loads large amounts of data, since the default behavior of the JBO classes is to load all data eagerly. If a view object with many rows and potentially very many child rows is loaded into memory, not only is there risk of memory-exhaustion, but DML actions taken based on such large data risk using all rollback segments.

## **10.2.2 How to Call a Decision Function with Java Decision Point Interface**

To call a decision function with a ruleset using ADF Business Components fact types with the Oracle Business Rules SDK Decision Point interface you must configure the decision function with certain options. For more information on using decision functions, see [Chapter 6, "Working with Decision Functions"](#).

### **To define a decision function using the Java Decision Point interface:**

1. Double-click the decision function icon to the left of the decision function item or select this item and click the **Edit** icon. The Edit Decision Function dialog appears.
2. In the Edit Decision Function dialog, configure the decision function:
  - **Input Fact Types:** names the fact types to use in the configured business rules.

The inputs, when working with an application using ADF Business Components fact types, are the ADF Business Components view objects used in your rules.

When you use the `setViewObject` method with a Decision Point, the **List** attribute should be unselected. Each Input fact type should have the **List** attribute selected when you are using `addInput` or `setInputs` methods with the Decision Point. Optionally, depending on the usage of the view objects, select the **Tree** attribute:

- **List**: defines that a list of ADF Business Components fact types are passed to the decision function.
- **Tree**: defines that all objects in the master-detail hierarchy should be asserted, instead of only the top-level object.

For more information, see [Section 10.2.1, "How to Call a Decision Point with ADF Business Components Facts"](#).

- **Output Fact Types**: defines the fact types that the caller returns.

When calling a decision function using the Java Decision Point interface for a decision function that uses ADF Business Components fact types, **Output Fact Types** should be left empty. The view object is updated using an `ActionType`. For more information, see [Section 10.1.2, "Understanding Oracle Business Rules Decision Point Action Type"](#).

- **RuleSets and Decision Functions**: an ordered list of the rulesets and other decision functions that this decision function executes. The rulesets `DecisionPointDictionary.Preprocessing` and `DecisionPointDictionary.Postprocessing` from the `DecisionPoint` dictionary must be added so that they run before and after, respectively, the application-specific rulesets and decision functions.

### 10.2.3 What You Need to Know About Decision Function Configuration with ADF Business Components

Both rulesets and decision functions may be included in the definition of a decision function. It is common for an application to require some rules or decision functions which act as "plumbing code". Such applications include components that perform transformations on the input data, assert auxiliary facts, or process output facts. The plumbing code may need to run before or after the rules that contain the core business rules of the application. You can separate these application concerns and their associated rules from the application functional concerns using *nested decision functions*. Using nested decision functions, the inner decision function does not contain the administrative, plumbing-oriented concerns, and thus only presents those rules which define the core logic of the application. This design eliminates the need for the user to understand the administrative rules and prevents a user from inappropriately modifying these rules (and possibly rendering the system inoperable due to these changes).

To create a configuration using multiple rulesets and nested decision functions, create two decision functions and add one to the other. A good naming scheme is to suffix the nested inner decision function with the name `Core`. The user specified rulesets can be added to the inner `Core` decision function. For example, `DecisionFunction_1` can be defined to run the `DecisionPointDictionary.Preprocessing` decision function, the `DecisionFunction_1Core` decision function, and the `DecisionPointDictionary.Postprocessing` decision function. For this example, `DecisionFunction_1Core` contains the core business logic rulesets.

It is also common for the input of a Decision Point to be an ADF Business Components fact type that is the root of a tree of ADF Business Components objects. However, the user might only write business rules that match on a subset of the types found in the

tree. In this case, it is a good practice to define the inputs of the nested decision functions to be only the types which are actually matched in the contained rulesets. For example, consider a Decision Point calling a decision function whose input is an `Employee` fact type with the **Tree** option selected; if this decision function includes a nested decision function with rulesets that only matched on the `Department` fact type. In this case, the nested decision function could either have as its input specified as an `Employee` fact type with the **Tree** option selected, or a `Department` fact type with the **List** option selected. For this example, the **Tree** option causes the children of the `Employee` instances, including the `Department` instances to be asserted (due to the one-to-many relationship between these types). If `Employee` is an input to the outer decision function and the **Tree** option is selected, the then `Department` fact type instances are asserted, and you can identify the signature on the inner decision function as a list of `Department` instances (these are the exact types which are being matched on for this decision function).

## 10.3 Creating a Business Rules Application with ADF Business Components Facts

The ADF Business Components sample application shows the use of ADF Business Component fact types.

The source code for Oracle Business Rules-specific samples and SOA samples are available online in the Oracle SOA Suite samples page.

### 10.3.1 How to Create an Application That Uses ADF Business Components Facts

To work with Oracle Business Rules with ADF Business Components facts, you first need to create an application and a project in Oracle JDeveloper.

#### To create an application that uses ADF Business Components facts:

1. Start Oracle JDeveloper. This displays the Oracle JDeveloper start page.
2. In the Application Navigator, in the application menu click **New Application...**
3. In the Name your application page enter the name and location for the new application:
  - a. In the **Application Name** field, enter an application name. For example, enter `Chapter10`.
  - b. In the **Directory** field, enter or browse for a directory name or accept the default.
  - c. In the Application **Package Prefix** field, enter an application package prefix. For example, enter `com.example`.  
 This should be a globally unique prefix and is commonly a domain name owned by your company. The prefix, followed by a period, applies to objects created in the initial project of an application.  
 In this sample, use the prefix `com.example`.
  - d. In the **Application Template** field, select **Fusion Web Application (ADF)**.
4. Click **Finish**.

### 10.3.2 How to Add the Chapter10 Generic Project

You need to add a new project named `Chapter10`.

**Add a new project:**

1. In the **Chapter10** application, select the Application Menu.
2. In the Application Menu list, select **New Project...**
3. In the New Gallery, in the **Items** area select **Generic Project**.
4. Click **OK**.
5. On the Name your project page, in the **Project Name** field enter Chapter10.
6. Click **Finish**.

### 10.3.3 How to Create ADF Business Components Application for Business Rules

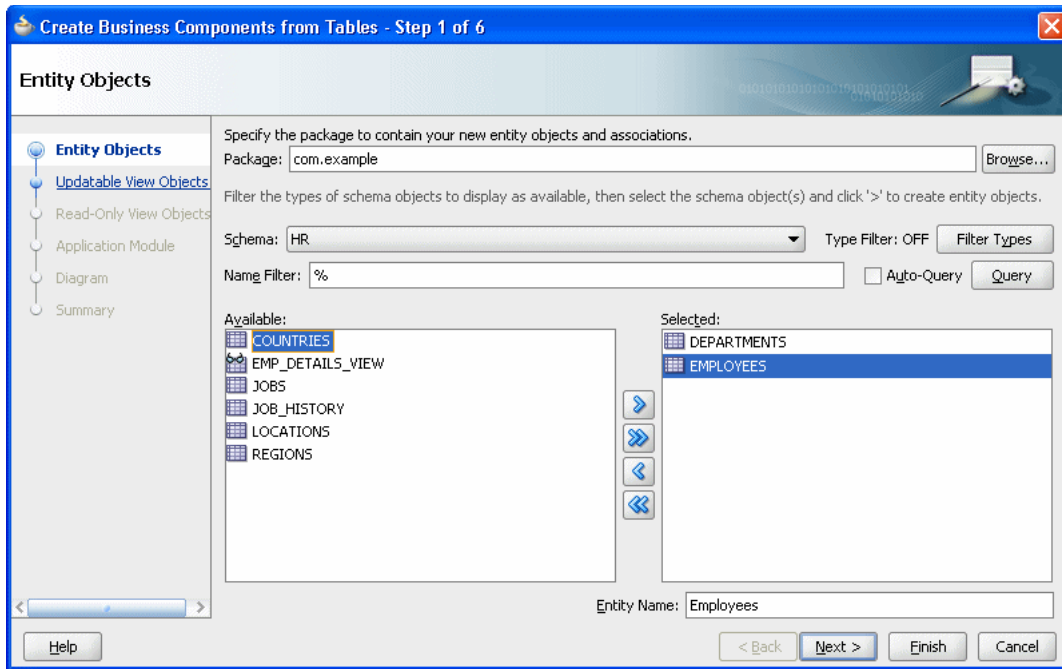
You need to add ADF Business Components from a database table. For this example we use the standard HR database tables.

**To add ADF Business Components:**

1. In the Application Navigator, select the **Chapter10** project.
2. Right-click and from the menu select **New...**
3. In the New Gallery, in the **Categories** area expand **Business Tier** and select **ADF Business Components**.
4. In the **Items** area select **Business Components from Tables**.
5. Click **OK**.
6. In the Initialize Business Components Project dialog, enter the required connection information to add a connection.
7. Click **OK**. This displays the Create Business Components from Tables wizard.
8. In the Entity Objects page, select the desired objects by moving objects from the **Available** box to the **Selected** box. You may need to click **Query** to see the complete list. For example, select **DEPARTMENTS** and **EMPLOYEES**, as shown in [Figure 10-2](#).

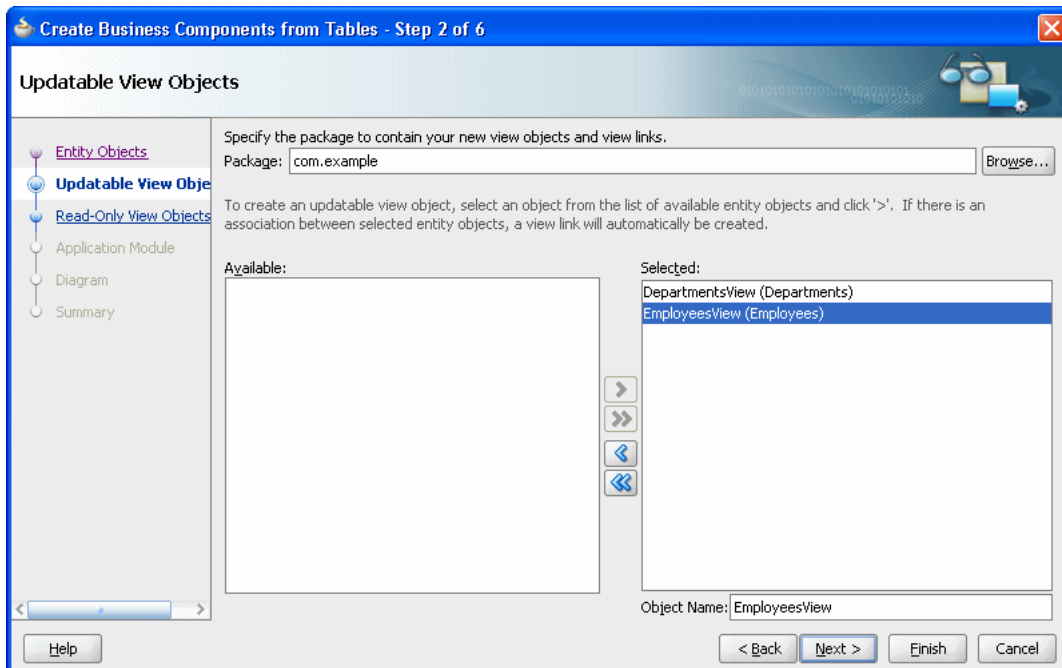


**Figure 10–2** *Selecting Entity Objects for Sample Application*



9. Click **Next**. This displays the Updatable View Objects page.
10. In the Updatable View Objects page select **Departments** and **Employees**, as shown in [Figure 10–3](#).

**Figure 10–3** *Adding Updatable View Objects for Sample Application*



11. Click **Next**. This displays the Read-Only View Objects page.
12. Click **Next**. This displays the Application Module page.

13. Click **Finish**.

### 10.3.4 How to Update View Object Tuning for Business Rules Sample Application

You should tune the `ViewObject` to meet the performance requirements of your application.

**To set tuning options for EmployeesView:**

1. In the Application Navigator, double-click **EmployeesView**.
2. In the **General** navigation tab, expand **Tuning**.
3. In the Tuning area, select **All Rows**.
4. In the Tuning area, in the **Batches of:** field, enter 128.
5. In the Tuning area, select **All at Once**.

**To set tuning options for DepartmentsView:**

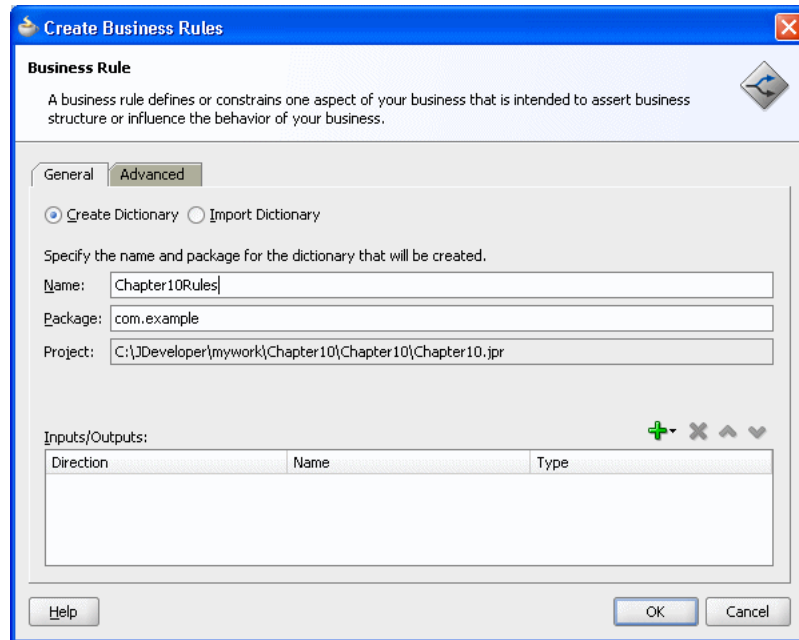
1. In the Application Navigator, double-click **DepartmentsView**.
2. In the **General** navigation tab, expand **Tuning**.
3. In the Tuning area, select **All Rows**.
4. In the Tuning area, in the **Batches of:** field, enter 128.
5. In the Tuning area, select **All at Once**.

### 10.3.5 How to Create a Dictionary for Oracle Business Rules

You use Oracle JDeveloper to create an Oracle Business Rules dictionary.

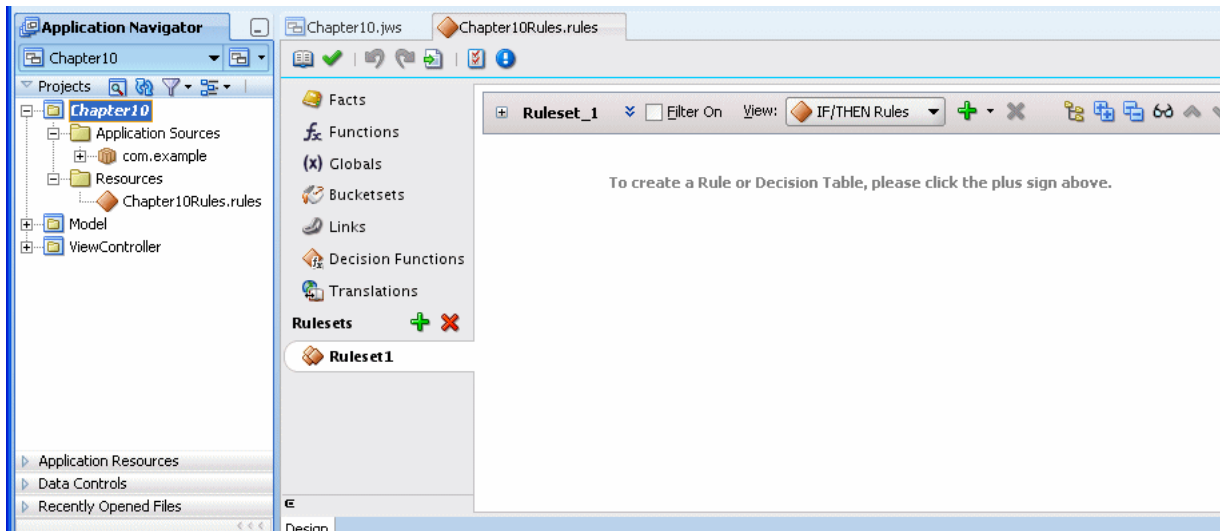
**To create a dictionary:**

1. In the Application Navigator, select the **Chapter10** project.
2. Right-click, and from the list select **New...**
3. In the New Gallery, select the **All Technologies** tab and in the **Categories** area expand **Business Tier** and select **Business Rules**.
4. In the New Gallery, in the **Items** area select **Business Rules**.
5. Click **OK**.
6. In the Create Business Rules dialog enter the dictionary name and package, as shown in [Figure 10-4](#):
  - For example, in the **Name** field enter `Chapter10Rules`.
  - For example, in the **Package** field enter `com.example`.

**Figure 10–4 Create Business Rules for Chapter10Rules Dictionary**

7. Click OK.

JDeveloper creates the dictionary and opens the `Chapter10Rules.rules` file in Rules Designer, as shown in [Figure 10–5](#).

**Figure 10–5 Adding the Rules Dictionary**

### 10.3.6 How to Add Decision Point Dictionary Links

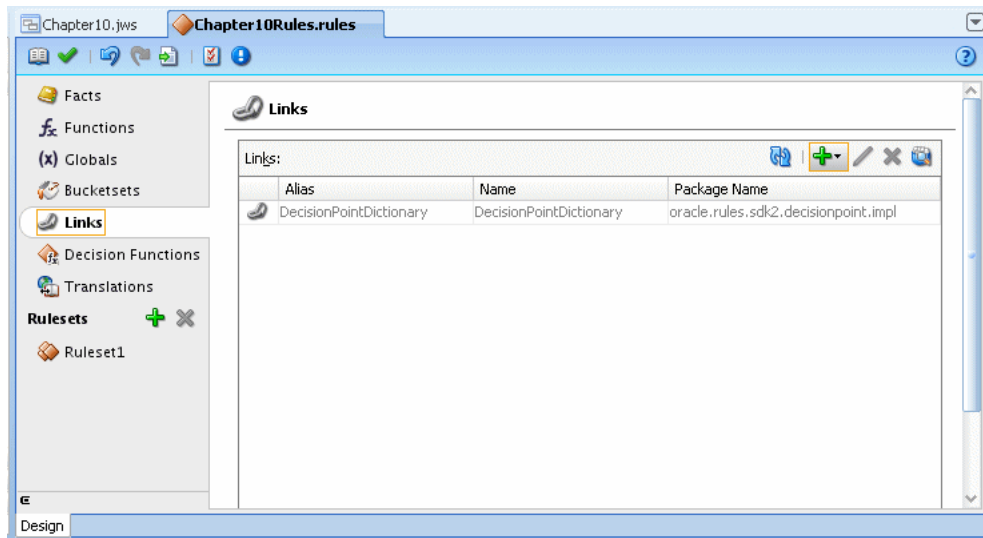
You need to add a dictionary links to the Oracle Business Rules supplied Decision Point Dictionary. This dictionary supports features for working with the Decision Point interface with ADF Business Components objects.

#### Add decision point dictionary links:

1. In the Rules Designer, click the **Links** navigation tab.

2. From the menu next to the **Create** icon, select **Decision Point Dictionary**. This operation can take awhile to complete. After waiting, Rules Designer adds a link to the Decision Point Dictionary as shown in [Figure 10-6](#).

**Figure 10-6 Adding a Dictionary Link to Decision Point Dictionary**



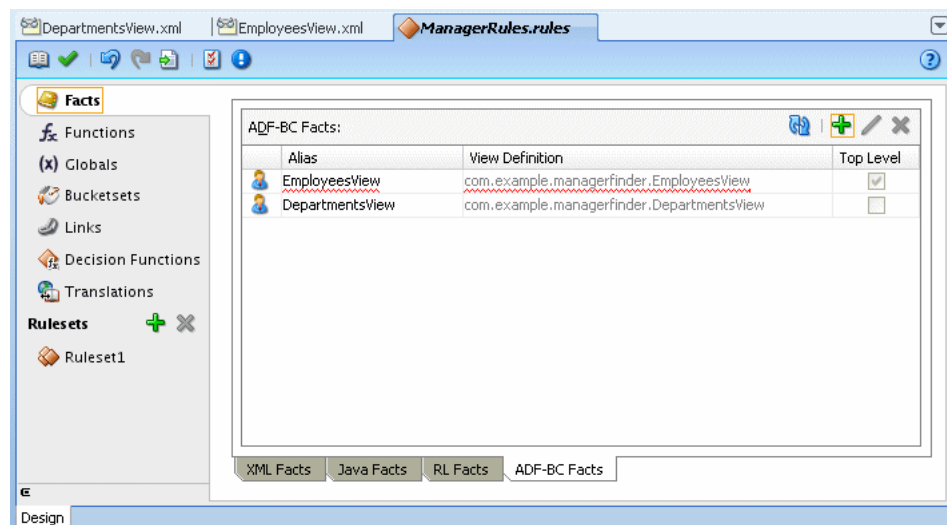
### 10.3.7 How to Import the ADF Business Components Facts

You import ADF Business Components facts with Rules Designer to make these objects available when you create rules.

**Import the ADF Business Components facts:**

1. In Rules Designer, select the **Facts** navigation tab.
2. Select the **ADF-BC Facts** tab.
3. Click the **Create...** icon. This displays the ADF Business Components Fact page.
4. In the **Connection** field, from the list select the connection which your ADF Business Components objects use. The **Search Classpath** area shows a list of classpaths.
5. In the **View Definition** field, select the name of the view object to import. For example, select **com.example.EmployeesView**.
6. Click **OK**. This displays the **Facts** navigation tab, as shown in [Figure 10-7](#).

Figure 10–7 ADF Business Components Facts in Rules Designer



ADF Business Components Facts can include a circular reference, as indicated with the validation warning:

RUL-05037: A circular definition exists in the data model

When this warning is shown in the Business Rule validation log, you need to manually resolve the circular reference. To do this you deselect the **Visible** checkbox for one of the properties that is involved in the circular reference.

#### To mark a property as non-visible:

1. Select the **Facts** navigation tab and select the ADF Business Components Facts tab.
2. Double-click the icon in the **DepartmentsView** row.
3. In the **Properties** table, in the **EmployeesView** row deselect the **Visible** checkbox.
4. Click **OK**.

#### To set alias for DepartmentsView and EmployeesView:

1. Select the **Facts** navigation tab and select the ADF Business Components Facts tab.
2. In the **Alias** column, replace **EmployeesView** with **Employeee**.
3. In the **Alias** column, replace **DepartmentsView** with **Department**.

### 10.3.8 How to Add and Run the Outside Manager Ruleset

The sample code that runs the outside manager ruleset invokes the Decision Point with the view object set using the `setInputs` method. This invokes the decision function once, with all of the view object rows loaded in a `List`. Note that invoking the Decision Point this way is not scalable, because all of the view object rows must be loaded into memory at the same time, which can lead to `OutOfMemory` exceptions. Only use this invocation style when there are a small and known number of view object rows. You can also use a Decision Point with `setViewObject`. For more information, see [Section 10.2.1, "How to Call a Decision Point with ADF Business Components Facts"](#).

### 10.3.8.1 How to Add the Outside Manager Ruleset and Add a Decision Function

After the view objects are imported as facts, you can rename the ruleset and create the decision function for the application.

#### To rename the ruleset:

1. In Rules Designer, select the **Ruleset\_1** navigation tab.
2. Select the ruleset name and enter `Outside Manager Ruleset` to rename the ruleset.

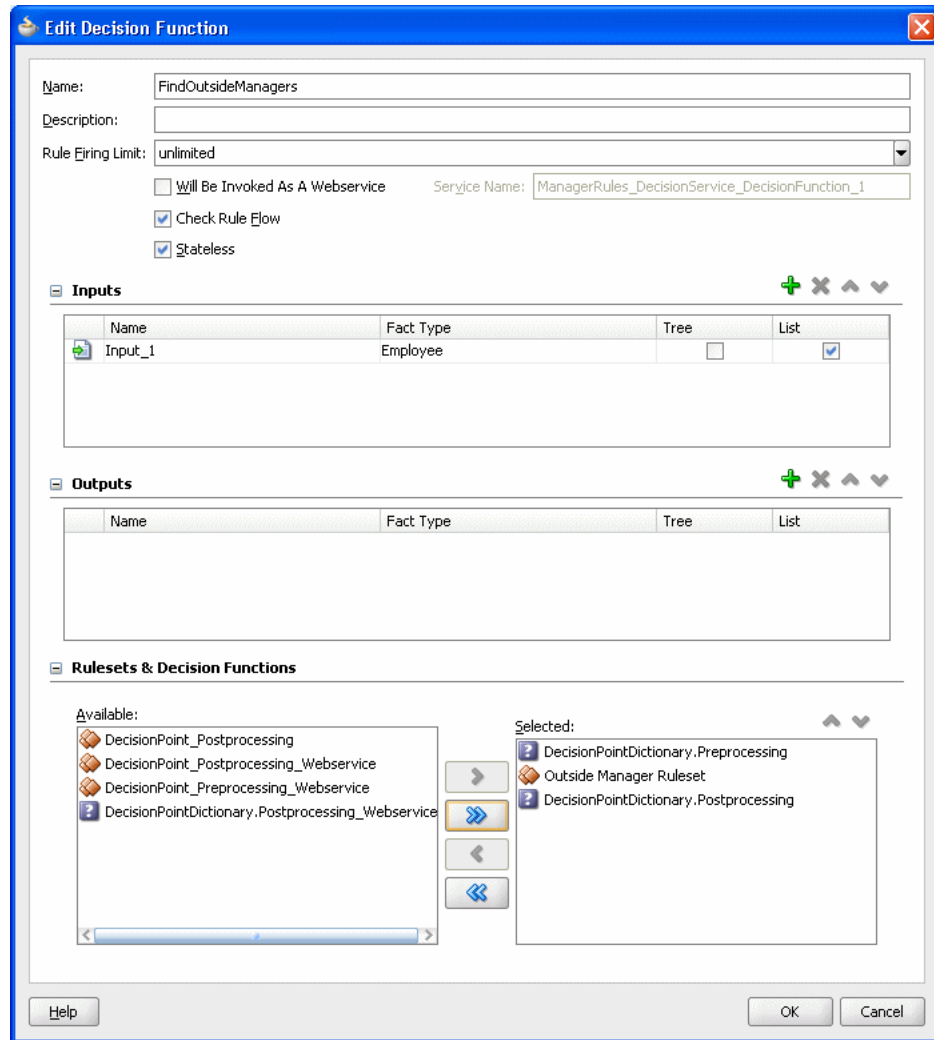
#### To add a decision function:

1. Click the **Decision Functions** navigation tab.
2. In the Decision Functions area, click **Create....** This displays the Edit Decision Function dialog.
3. Edit the decision function fields as follows, as shown in [Figure 10-8](#).
  - Enter **Name** value `FindOutsideManagers`.
  - In the **Inputs** area, click the **Add Input** icon and edit the input information as follows:
    - Click the **Fact Type** field and select **Employee** from the list.
    - Select the **List** checkbox.

In this decision function you do not define any outputs because you use the `ActionType` API for taking action rather than producing output. For more information, see [Section 10.1.2, "Understanding Oracle Business Rules Decision Point Action Type"](#).

- In the **Rulesets & Decision Functions** area move the following items from the Available area to the Selected area, in the specified order:
  - **DecisionPointDictionary.Preprocessing**
  - **Outside Manager Ruleset**
  - **DecisionPointDictionary.Postprocessing**

**Figure 10–8 Adding the Find Outside Managers Decision Function**



4. Ensure that the items in the Selected area are in the order shown in [Figure 10–8](#). If they are not, select an item and use the **Move Up** and **Move Down** buttons to correct the order.
5. Click **OK**.

Several warnings appear. These warnings are removed in later steps when you add rules to the ruleset.

### 10.3.8.2 How to Create the ActionType Java Implementation Class

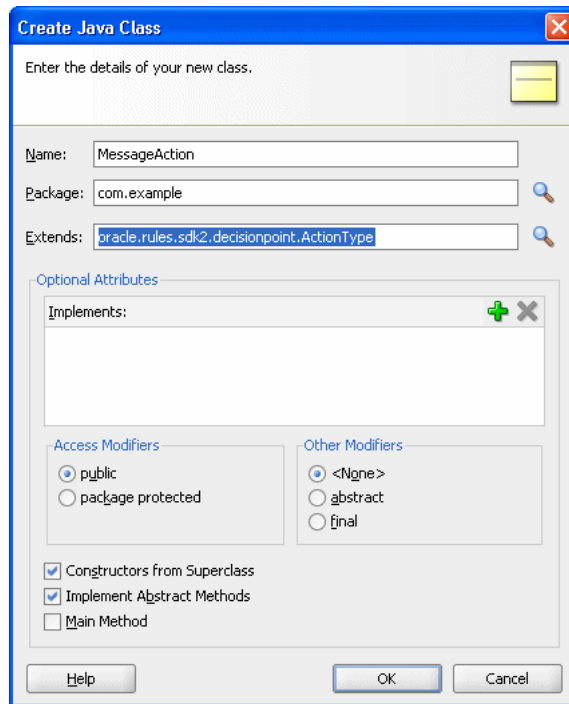
To create the sample application and to modify the view object in a rule, you need to create a Java implementation class for abstract class `oracle.rules.sdk2.decisionpoint.ActionType`. All subclasses of `ActionType` must implement the abstract `exec` method.

#### To create the ActionType Java implementation class:

1. In Oracle JDeveloper, select the project named **Chapter10**.
2. In the Application Navigator, select the **Application Sources** folder.
3. Right-click and from the list select **New...**

4. In the New Gallery, in the **Categories** area select **General**.
5. In the New Gallery, in the **Items** area select **Java Class**.
6. Click **OK**.
7. In the Create Java Class dialog, configure the following properties as shown in [Figure 10–9](#):
  - Enter the **Name** value `MessageAction`.
  - Enter the **Package** value `com.example`.
  - Enter the **Extends** value `oracle.rules.sdk2.decisionpoint.ActionType`.

**Figure 10–9** *Creating the Message Action Type Java Class*



8. Click **OK**.  
Oracle JDeveloper displays the Java Class.
9. Replace this code with the code shown in [Example 10–4](#).

**Example 10–4** *ActionType Java Implementation*

```
package com.example;

import oracle.rules.sdk2.decisionpoint.ActionType;
import oracle.rules.sdk2.decisionpoint.DecisionPointInstance;

public class MessageAction extends ActionType {
    public MessageAction() {
        super();
    }

    public void exec(DecisionPointInstance decisionPointInstance) {
        System.out.println(message);
    }
}
```



```

private String message = null;

public void setMessage(String message) {
    this.message = message;
}

public String getMessage() {
    return message;
}
}

```

10. In the Application Navigator, right click the `MessageAction.java` and from the list select **Make**.

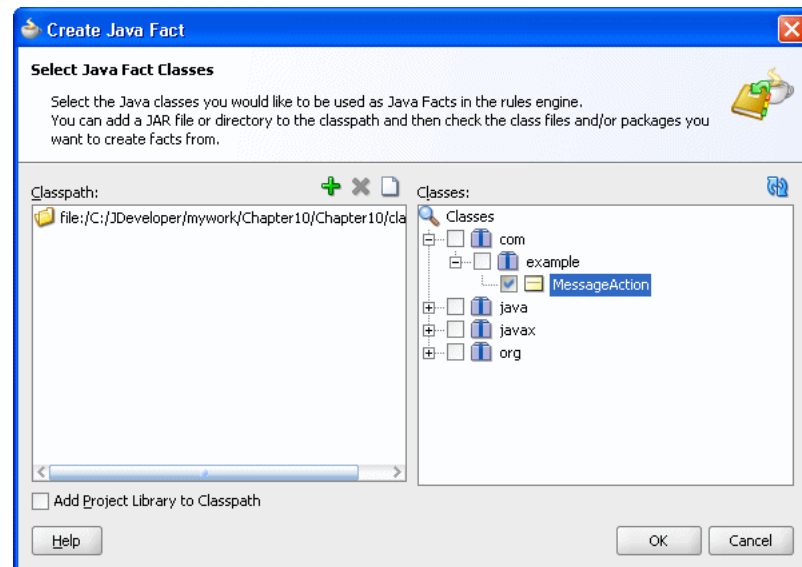
### 10.3.8.3 How to Import the Message Action Java Fact

You just created a new Java class and you need to add this class as a Java fact type in Rules Designer to use later when you create rules.

#### To create the Java fact type:

1. In Rules Designer, click the **Facts** navigation tab.
2. Select the **Java Facts** tab.
3. Click **Create...**
4. In the Create Java Fact dialog, in the Classes area navigate in the tree and expand `com` and `example` to display the **MessageAction** checkbox.
5. Select the **MessageAction** checkbox, as shown in [Figure 10–10](#).

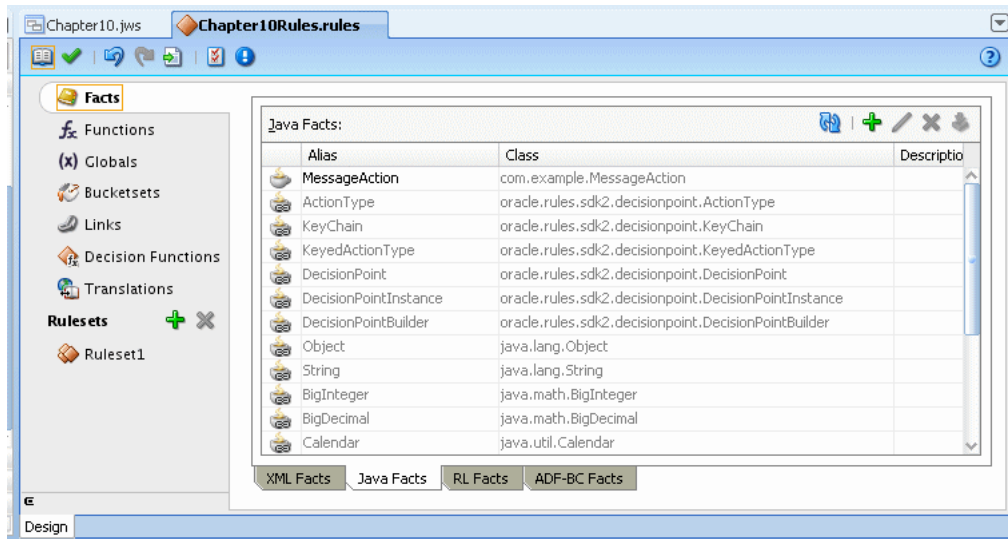
**Figure 10–10** Create Java Fact with Message Action Type



6. Click **OK**.

This adds the fact to the table, as shown in [Figure 10–11](#).

**Figure 10–11 Adding the Message Action Type Java Fact**



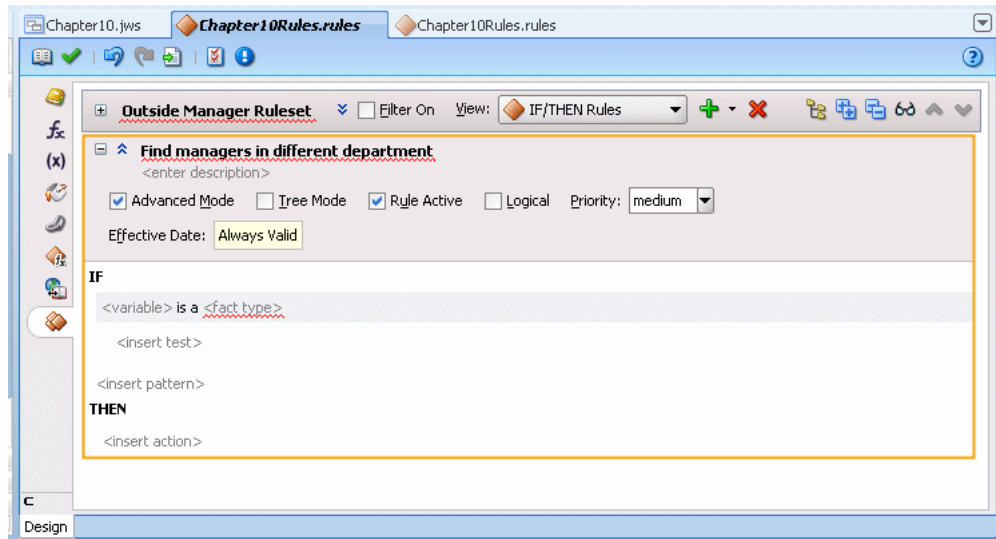
### 10.3.8.4 How to Add the Find Managers Rule

You add the rule to find the managers that are in a different departments than their employees.

#### To add the find managers in different departments rule:

1. In Rules Designer, select the **Outside Manager Ruleset** tab.
2. Click **Add** and from the list select **Create Rule**.
3. Rename the rule by selecting the default rule name **Rule\_1**. This displays a text entry area. You enter a name. For example, enter **Find managers in different department**. Press **Enter** to apply the name.
4. Click **Show Advanced Settings**. For more information, see [Section 4.5.1, "How to Show and Hide Advanced Settings in a Rule or Decision Table"](#).
5. In the rule select **Advanced Mode**, as shown in [Figure 10–12](#).

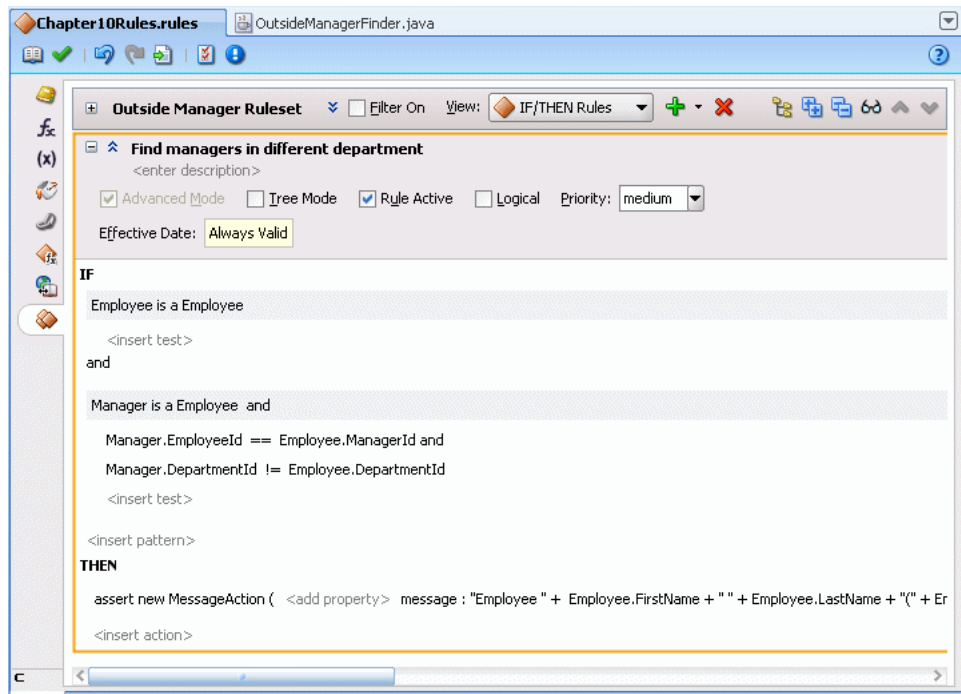
**Figure 10–12 Adding the Find Managers in Different Departments Rule**



6. Enter the rule as shown in Figure 10–13. The action for the rule shown in the **THEN** area is too long to show in the figure. The complete action that you build includes the following items:

```
"Employee " + Employee.FirstName + " " + Employee.LastName + "(" +
Employee.EmployeeId + ")" + " in dept " + Employee.DepartmentId + " has
manager outside of department, " + Manager.FirstName + " " + Manager.LastName
+ "(" + Manager.EmployeeId + ")" + " in dept " + Manager.DepartmentId
```

**Figure 10–13 Find Managers in Different Departments Rule**



### 10.3.8.5 How to Add the Outside Manager Finder Class

Add the outside manager finder class. This uses the Decision Point to execute a decision function.

#### To add the Outside Manager Finder Class:

1. Select the **Chapter10** project.
2. Right-click and select **New...**
3. In the New Gallery, in the **Categories** area select **General**.
4. In the New Gallery, in the **Items** area select **Java Class**.
5. Click **OK**.
6. In the **Name** field, enter `OutsideManagerFinder`.
7. Click **OK**.
8. Replace the contents of this class with the code shown in [Example 10-5](#).

#### **Example 10-5** Outside Manager Finder Java Class with Decision Point

```
package com.example;

import java.util.ArrayList;

import oracle.jbo.ApplicationModule;
import oracle.jbo.ViewObject;
import oracle.jbo.client.Configuration;

import oracle.rules.rl.exceptions.RLException;
import oracle.rules.sdk2.decisionpoint.DecisionPoint;
import oracle.rules.sdk2.decisionpoint.DecisionPointBuilder;
import oracle.rules.sdk2.decisionpoint.DecisionPointInstance;
import oracle.rules.sdk2.exception.SDKException;
import oracle.rules.sdk2.repository.DictionaryFQN;

public class OutsideManagerFinder {
    private static final String AM_DEF = "com.example.AppModule";
    private static final String CONFIG = "AppModuleLocal";
    private static final String VO_NAME = "EmployeesView1";

    private static final DictionaryFQN DICT_FQN =
        new DictionaryFQN("com.example", "Chapter10Rules");

    private static final String DF_NAME = "FindOutsideManagers";

    private DecisionPoint dp = null;

    public OutsideManagerFinder() {
        try {
            dp = new DecisionPointBuilder()
                .with(DICT_FQN)
                .with(DF_NAME)
                .build();
        } catch (SDKException e) {
            System.err.println(e);
        }
    }

    public void run() {
```

```

final ApplicationModule am =
    Configuration.createRootApplicationModule(AM_DEF, CONFIG);
final ViewObject vo = am.findViewObject(VO_NAME);
final DecisionPointInstance point = dp.getInstance();
point.setInputs(new ArrayList<Object>(){{ add(vo); }});
try {
    point.invoke();
} catch (RLEException e) {
    System.err.println(e);
} catch (SDKException e) {
    System.err.println(e);
}
}

public static void main(String[] args) {
    OutsideManagerFinder omf = new OutsideManagerFinder();
    omf.run();
}
}

```

### 10.3.8.6 How to Update ADF META INF for Local Dictionary Access

You need to update the `ADF-META-INF` file with MDS information for accessing the dictionary. You can use a local file with MDS to access the Oracle Business Rules dictionary. However, this procedure is not the usual dictionary access method with Oracle Business Rules in a production environment. For information on using a Decision Point to access a dictionary with MDS in a production environment, see [Section 7.5, "What You Need to Know About Using Decision Point in a Production Environment"](#).

#### Update ADF-META-INF:

1. In the Application Navigator, expand **Application Resources**.
2. Expand **Descriptors** and **ADF META-INF** folders.
3. Double-click `adf-config.xml` to open this file.
4. Click the **Source** tab to view the `adf-config.xml` source.
5. Add the MDS information to `adf-config.xml`, before the closing `</adf-config>` tag, as shown in [Example 10-6](#).

#### Example 10-6 Adding MDS Elements to `adf-config.xml` for Local Dictionary Access

```

<adf-mds-config xmlns="http://xmlns.oracle.com/adf/mds/config">
  <mds-config version="11.1.1.000" xmlns="http://xmlns.oracle.com/mds/config">
    <persistence-config>
      <metadata-namespaces>
        <namespace metadata-store-usage="mstore-usage_1" path="/" />
      </metadata-namespaces>
      <metadata-store-usages>
        <metadata-store-usage id="mstore-usage_1">
          <metadata-store
class-name="oracle.mds.persistence.stores.file.FileMetadataStore">
            <property name="metadata-path"
                value="C:\jdevinstance\mywork\Chapter10\adf\" />
          </metadata-store>
        </metadata-store-usage>
      </metadata-store-usages>
    </persistence-config>
  </mds-config>
</adf-config>

```

```

        </persistence-config>
    </mds-config>
</adf-mds-config>

```

6. In the `<property>` element with the attribute `metadata-path`, change the path to match `.adf` directory in the application on your system.

**Copy definitions to MDS accessible location:**

1. In a file system navigator, outside of Oracle JDeveloper navigate to the **Chapter10** application, and in the **Chapter10** project, in the `src` folder select and copy the `com` folder.
2. In the application directory for **Chapter10**, above the **Chapter10** project, navigate to the `.adf` directory.
3. Copy the `com` folder to this directory.

**Copy dictionary to MDS accessible location:**

1. In a file system navigator, outside of Oracle JDeveloper navigate to the **Chapter10** application and in the **Chapter10** project, copy the `oracle` directory that contains the Oracle Business Rules dictionary.
2. In the application directory for **Chapter10**, above the **Chapter10** project, navigate to the `.adf` directory.
3. Copy the `oracle` folder to this directory.

### 10.3.8.7 How to Build and Run the Project to Check the Outside Manager Finder

You can build and test the project by running the find managers with employees in different departments rule.

**Build the OutsideManagerFinder configuration:**

1. From the dropdown menu next to **Run** icon, select **Manage Run Configurations...**
2. In the Project Properties dialog, click **New...**
3. In the Create Run Configuration dialog, enter a name. For example, enter `OutsideManagerFinder`.
4. Click **OK**.
5. With `OutsideManagerFinder` selected, click **Edit...**
6. In the **Default Run Target** field, click **Browse...**
7. Select `OutsideManagerFinder.java` from the `src\com\example` folder.
8. Click **Open**.
9. In the Edit Run Configuration dialog, click **OK**.
10. In the Project Properties dialog, click **OK**.

**Run the project:**

1. In the dropdown menu next to the **Run** project icon, select **OutsideManagerFinder**.
2. Running this configuration generates output, as shown in [Example 10-7](#).

**Example 10–7 Running the OutsideManagerFinder Ruleset**

Emp Shelley Higgins(205) in dept 110 manager outside of department, Neena Kochhar(101) in dept 90  
 Emp Hermann Baer(204) in dept 70 manager outside of department, Neena Kochhar(101) in dept 90  
 Emp Susan Mavris(203) in dept 40 manager outside of department, Neena Kochhar(101) in dept 90  
 Emp Michael Hartstein(201) in dept 20 manager outside of department, Steven King(100) in dept 90  
 Emp Jennifer Whalen(200) in dept 10 manager outside of department, Neena Kochhar(101) in dept 90  
 Emp Kimberely Grant(178) in dept null manager outside of department, Eleni Zlotkey(149) in dept 80  
 Emp Eleni Zlotkey(149) in dept 80 manager outside of department, Steven King(100) in dept 90  
 Emp Gerald Cambrault(148) in dept 80 manager outside of department, Steven King(100) in dept 90  
 Emp Alberto Errazuriz(147) in dept 80 manager outside of department, Steven King(100) in dept 90  
 Emp Karen Partners(146) in dept 80 manager outside of department, Steven King(100) in dept 90  
 Emp John Russell(145) in dept 80 manager outside of department, Steven King(100) in dept 90  
 Emp Kevin Mourgous(124) in dept 50 manager outside of department, Steven King(100) in dept 90  
 Emp Shanta Vollman(123) in dept 50 manager outside of department, Steven King(100) in dept 90  
 Emp Payam Kaufling(122) in dept 50 manager outside of department, Steven King(100) in dept 90  
 Emp Adam Fripp(121) in dept 50 manager outside of department, Steven King(100) in dept 90  
 Emp Matthew Weiss(120) in dept 50 manager outside of department, Steven King(100) in dept 90  
 Emp Den Raphaely(114) in dept 30 manager outside of department, Steven King(100) in dept 90  
 Emp Nancy Greenberg(108) in dept 100 manager outside of department, Neena Kochhar(101) in dept 90  
 Emp Alexander Hunold(103) in dept 60 manager outside of department, Lex De Haan(102) in dept 90

**10.3.9 How to Add and Run the Department Manager Ruleset**

The sample code that runs the department manager ruleset invokes the Decision Point with the view object set using the `setViewObject` method. This invokes the decision function once for each row in the view object. All decision function calls occur in the same RuleSession. Between decision function calls, the RuleSession preserves all state from the previous decision function call. Thus, any objects asserted during the previous call remain in working memory for the next call unless they are explicitly retracted by rulesets that you supply. When the state is maintained, you can retract all facts or selectively retract facts between calls by running a ruleset with rules that use the retract action. This ruleset is run as part of the same decision function that you use with the Decision Point. The retract all employees ruleset demonstrates retracting these facts, as shown in [Figure 10–15](#). For more information, see [Section 10.2.1, "How to Call a Decision Point with ADF Business Components Facts"](#).

**10.3.9.1 How to Add the Department Manager Finder Ruleset**

You now add the department manager finder ruleset.

**To add the department manager finder ruleset:**

1. In Rules Designer, click **Create Ruleset...**
2. In the Create Ruleset dialog, in the **Name** field enter `Department Manager Finder Ruleset`.
3. Click **OK**.

**10.3.9.2 How to Add the Find Rule in the Department Manager Finder Ruleset**

Next you add the **Find** rule to find department managers. This rule demonstrates the use of **Tree Mode** rules with Oracle ADF Business Components fact types.

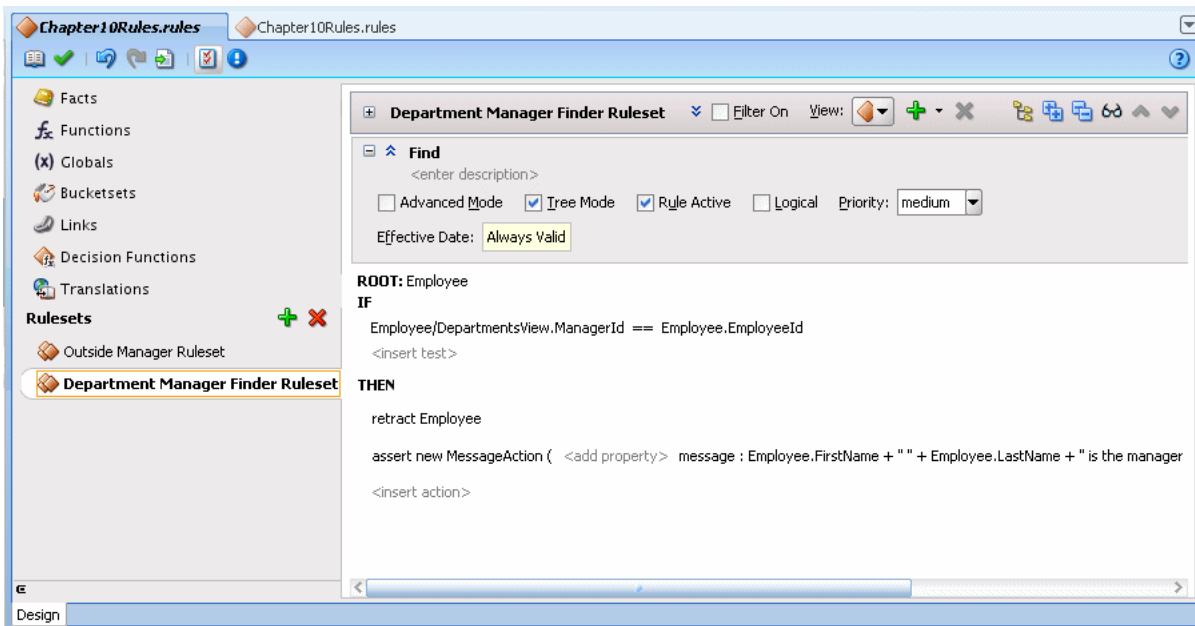
**Add department manager finder rule:**

1. In Rules Designer select the Department Manager Finder Ruleset.
2. In the dropdown menu next to the **Add** icon, click **Create Rule**.
3. Change the rule name by selecting the name **Rule\_1**, and entering `Find`.

4. Click **Show Advanced Settings**. For more information, see [Section 4.5.1, "How to Show and Hide Advanced Settings in a Rule or Decision Table"](#).
5. In the rule, select **Tree Mode**.
6. Enter the **Find** rule tests and actions, as shown in [Figure 10–14](#). The **THEN** area includes the assert that is too wide for the figure. The following shows the complete text of this rule, which is missing in [Figure 10–14](#):

```
Employee.FirstName + " " + Employee.LastName + " is the manager of dept " +
Employee/DepartmentsView.DepartmentName
```

**Figure 10–14 Adding the Find Rule to the Department Manager Finder Ruleset**



### 10.3.9.3 How to Add Retract Employees Ruleset

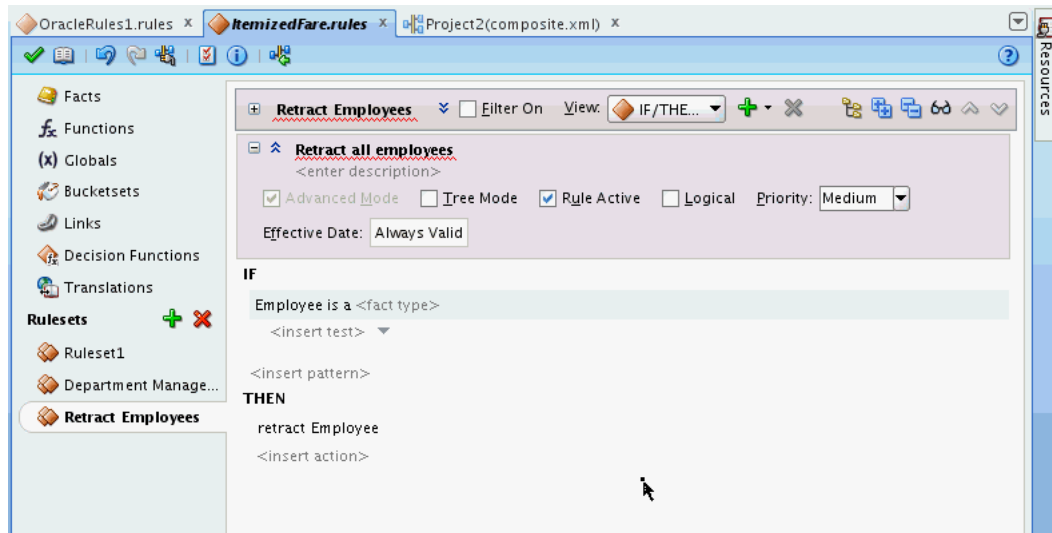
You add a ruleset to retract the employee fact type instances. This ensures that the Employee fact type is removed between invocations of the decision function.

**To add the retract employee ruleset:**

1. Add the Retract Employees Ruleset.
2. In the Retract Employees Ruleset, add a rule and name it **Retract all employees**, as shown in [Figure 10–15](#).



Figure 10–15 Adding the Retract All Employees Rule



#### 10.3.9.4 How to Add the Find Department Managers Decision Function

Now you create the decision function for the department manager finder ruleset. You use this decision function to execute the ruleset from a Decision Point.

##### To add a decision function for department manager finder ruleset:

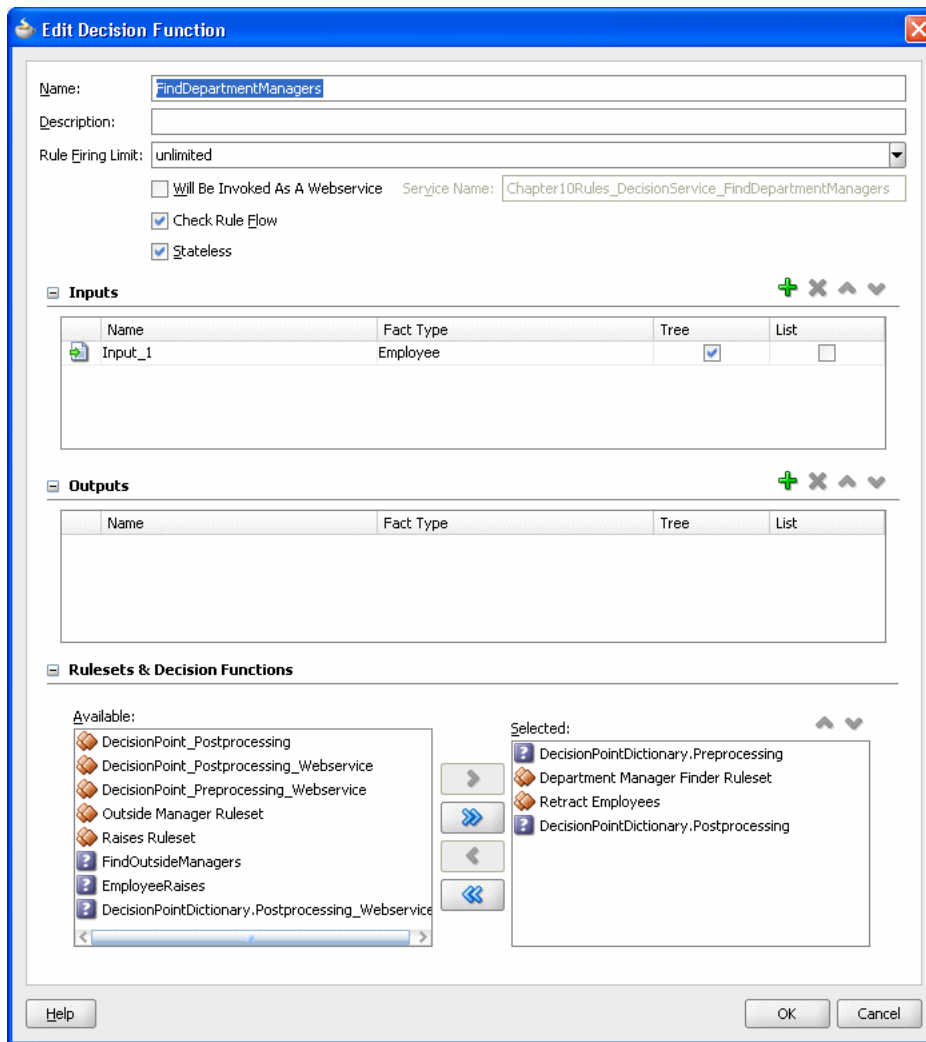
1. Click the **Decision Functions** navigation tab.
2. In the Decision Functions area, click **Create...** This displays the Edit Decision Function dialog.
3. Update the decision function fields as follows, as shown in [Figure 10–16](#).

- Enter **Name** value FindDepartmentManagers.
- In the **Inputs** area, click the **Add Input** and edit the input information as follows:
  - Click the **Fact Type** field and select **Employee** from the list.
  - Select the **Tree** checkbox.

In this decision function you do not define any outputs, because you use the `ActionType` API for taking action rather than producing output.

- In the **Rulesets & Decision Functions** area, move the following items from the **Available** area to the **Selected** area, in the specified order:
  - **DecisionPointDictionary.Preprocessing**
  - **Department Manager Finder Ruleset**
  - **Retract Employees**
  - **DecisionPointDictionary.Postprocessing**

**Figure 10–16 Adding the Find Department Managers Decision Function**



4. Ensure that the items in the **Selected** area are in the order shown in [Figure 10–16](#). If they are not, select an item and use the **Move Up** and **Move Down** buttons to correct the order.
5. Click **OK**.

### 10.3.9.5 How to Add the Department Manager Finder Java Class

Add the department manager finder class. This class include the code with the Decision Point that executes the decision function.

#### Add the department manager finder class:

1. In the Application Navigator, select the **Chapter10** project.
2. Right-click and select **New...**
3. In the New Gallery, in the **Categories** area select **General**.
4. In the New Gallery, in the **Items** area, select **Java Class**.
5. Click **OK**.
6. In the **Name** field, enter `DeptManagerFinder`.

7. Click OK.
8. Replace the contents of this class with the code shown in [Example 10-8](#).

**Example 10-8 Department Manager Finder Class**

```
package com.example;

import oracle.jbo.ApplicationModule;
import oracle.jbo.ViewObject;
import oracle.jbo.client.Configuration;
import oracle.jbo.server.DBTransactionImpl2;

import oracle.rules.rl.exceptions.RLException;
import oracle.rules.sdk2.decisionpoint.DecisionPoint;
import oracle.rules.sdk2.decisionpoint.DecisionPointBuilder;
import oracle.rules.sdk2.decisionpoint.DecisionPointInstance;
import oracle.rules.sdk2.exception.SDKException;
import oracle.rules.sdk2.repository.DictionaryFQN;

public class DeptManagerFinder {
    private static final String AM_DEF = "com.example AppModule";
    private static final String CONFIG = "AppModuleLocal";
    private static final String VO_NAME = "EmployeesView1";

    private static final String DF_NAME = "FindDepartmentManagers";

    private static final DictionaryFQN DICT_FQN =
        new DictionaryFQN("com.example", "Chapter10Rules");

    private DecisionPoint dp = null;

    public DeptManagerFinder() {

        try {
            dp = new DecisionPointBuilder()
                .with(DICT_FQN)
                .with(DF_NAME)
                .build();
        } catch (SDKException e) {
            System.err.println(e);
        }
    }

    public void run() {
        final ApplicationModule am =
            Configuration.createRootApplicationModule(AM_DEF, CONFIG);
        final ViewObject vo = am.findViewObject(VO_NAME);
        final DecisionPointInstance point = dp.getInstance();

        point.setTransaction((DBTransactionImpl2)am.getTransaction());
        point.setAutoCommit(true);
        point.setViewObject(vo);
        try {
            point.invoke();
        } catch (RLException e) {
            System.err.println(e);
        } catch (SDKException e) {
            System.err.println(e);
        }
    }
}
```

```
public static void main(String[] args) {  
    new DeptManagerFinder().run();  
}  
}
```

### 10.3.9.6 How to Copy the Dictionary to an MDS Accessible Location

Copy the updated dictionary to an MDS accessible location.

#### Copy dictionary to MDS accessible location:

1. In a file system navigator, outside of Oracle JDeveloper, navigate to the **Chapter10** application, and project and copy the **oracle** directory that contains the dictionary.
2. In the application directory for **Chapter10**, above the **Chapter10** project, navigate to the **.adf** directory.
3. Copy the **oracle** folder to this directory.

### 10.3.9.7 How to Build and Run the Project to Check the Find Managers Rule

You can build and test the project to execute the department manager finder ruleset.

#### Build the project:

1. From the dropdown menu next to **Run** icon, select **Manage Run Configurations...**
2. In the Project Properties dialog, click **New...**
3. In the Create Run Configuration dialog, enter the name. For example, enter **DeptManagerFinder**.
4. In the **Copy Settings From** field, enter **Default**.
5. Click **OK**.
6. With **DeptManagerFinder** selected, click **Edit...**
7. In the **Default Run Target** field, click **Browse...**
8. Select **DeptManagerFinder.java** from the **src\com\example** directory.
9. Click **Open**.
10. In the Edit Run Configuration dialog, click **OK**.
11. In the Project Properties dialog, click **OK**.

#### Run the project:

1. In the menu, next to the **Run** project icon, select **DeptManager Finder**.
2. Running the decision point generates output, as shown in [Example 10–9](#).

#### **Example 10–9** Output from Department Manager Finder Ruleset

```
Michael Hartstein is the manager of dept Marketing  
John Russell is the manager of dept Sales  
Adam Fripp is the manager of dept Shipping  
Den Raphaely is the manager of dept Purchasing  
Alexander Hunold is the manager of dept IT  
Shelley Higgins is the manager of dept Accounting  
Hermann Baer is the manager of dept Public Relations  
Susan Mavris is the manager of dept Human Resources
```

Jennifer Whalen is the manager of dept Administration  
 Nancy Greenberg is the manager of dept Finance  
 Steven King is the manager of dept Executive  
 Shelley Higgins is the manager of dept Accounting  
 Hermann Baer is the manager of dept Public Relations  
 Susan Mavris is the manager of dept Human Resources  
 Jennifer Whalen is the manager of dept Administration  
 Nancy Greenberg is the manager of dept Finance  
 Alexander Hunold is the manager of dept IT  
 Alexander Hunold is the manager of dept IT  
 Nancy Greenberg is the manager of dept Finance  
 Den Raphaely is the manager of dept Purchasing  
 Adam Fripp is the manager of dept Shipping  
 John Russell is the manager of dept Sales  
 Jennifer Whalen is the manager of dept Administration  
 Michael Hartstein is the manager of dept Marketing  
 Susan Mavris is the manager of dept Human Resources  
 Hermann Baer is the manager of dept Public Relations  
 Shelley Higgins is the manager of dept Accounting

When you see duplicate entries in the output, when working with tree mode rules in this example, the duplicate entries are due to multiple rule firings on the same data in a different part of the view object graph.

### 10.3.10 How to Add and Run the Raises and Retract Employees Rulesets

The sample code that runs the raises ruleset invokes the Decision Point by specifying the view object using the `setViewObject` method. This invokes the decision function once for each row in the view object. The retract employees ruleset retracts all instances of `Employee` asserted for each call, so that they do not remain in working memory between calls to the decision function. The action type shown in [Example 10–10](#) shows how to change the `ViewRowImpl` attribute values with a `ActionType`. For more information, see [Section 10.2.1, "How to Call a Decision Point with ADF Business Components Facts"](#).

#### 10.3.10.1 How to Add the Raises Ruleset

You now add the raises ruleset.

##### To add the raises ruleset:

1. In Rules Designer, click **Create Ruleset...**
2. In the Create Ruleset dialog, in the **Name** field enter `Raises Ruleset`.
3. Click **OK**.

#### 10.3.10.2 How to Create the Raise ActionType Java Implementation Class

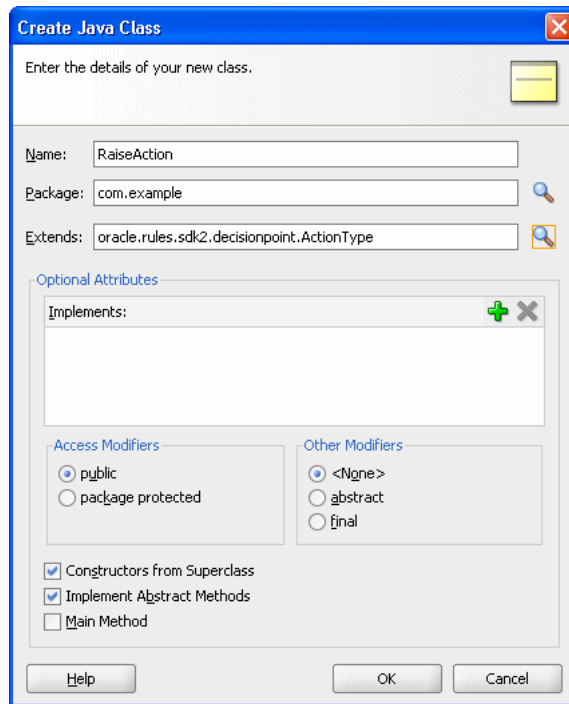
To create this part of the sample application and to modify the view object in the raises rule, you need to create a Java implementation class for the abstract class `oracle.rules.sdk2.decisionpoint.ActionType`. All subclasses of `ActionType` must implement the abstract `exec` method.

##### To create the raise ActionType Java implementation class:

1. In Oracle JDeveloper, select the project named **Chapter10**.
2. In the Application Navigator, select the **Application Sources** folder.
3. Right-click and from the list select **New...**

4. In the New Gallery, in the **Categories** area select **General**.
5. In the New Gallery, in the **Items** area select **Java Class**.
6. Click **OK**.
7. In the Create Java Class dialog, configure the following properties as shown in [Figure 10-17](#):
  - Enter the **Name** value `RaiseAction`.
  - Enter the **Package** value `com.example`.
  - Enter the **Extends** value `oracle.rules.sdk2.decisionpoint.ActionType`.

**Figure 10-17** *Creating the Raise ActionType Java Class*



8. Click **OK**.  
Oracle JDeveloper displays the Java Class.
9. Replace this code with the code shown in [Example 10-10](#).

**Example 10-10** *ActionType Java Implementation*

```
package com.example;

import oracle.jbo.domain.Number;

import oracle.rules.sdk2.decisionpoint.ActionType;
import oracle.rules.sdk2.decisionpoint.DecisionPointInstance;

public class RaiseAction extends ActionType {
    private double raisePercent;

    public void exec(DecisionPointInstance dpi) {
        Number salary = (Number)getViewRowImpl().getAttribute("Salary");
        salary = (Number)salary.multiply(1.0d + getRaisePercent()).scale(100,2, new
boolean[] {false});
    }
}
```

```

dpi.addResult("raise for " + this.getViewRowImpl().getAttribute("EmployeeId"),
            getRaisePercent() + "=>" + salary );
getViewRowImpl().setAttribute("Salary", salary);
}

public void setRaisePercent(double raisePercent) {
    this.raisePercent = raisePercent;
}

public double getRaisePercent() {
    return raisePercent;
}
}

```

10. In the Application Navigator, right click the `RaiseAction.java` and from the list select **Make**.

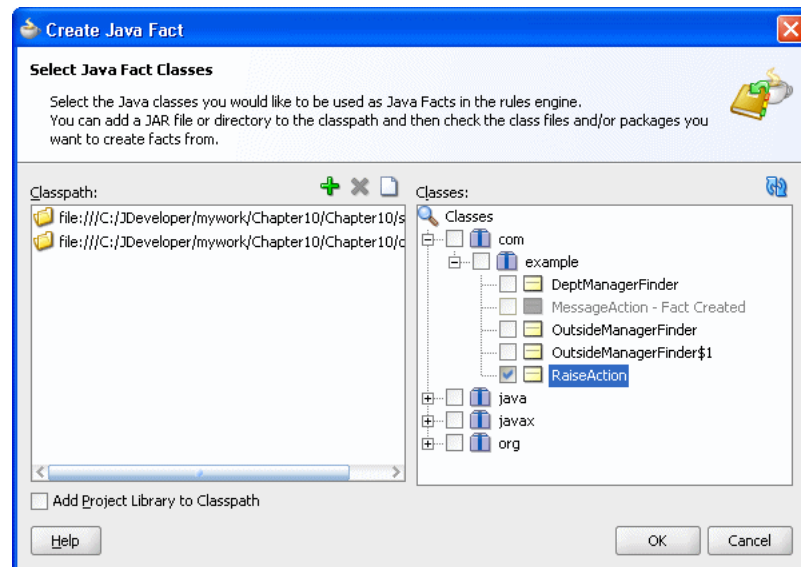
### 10.3.10.3 How to Import the Raise Action Java Fact

You just created a new Java class. You import this class as a Java fact type in Rules Designer to use later when you create rules.

#### To create the Java fact type:

1. In Rules Designer, select the `ManagerRules.rules` dictionary.
2. Click the **Facts** navigation tab and select the **Java Facts** tab.
3. Click **Create...**
4. In the Create Java Fact dialog, in the Classes area navigate in the tree and expand `com` and `example` to display the **RaiseAction** checkbox.
5. Select the **RaiseAction** checkbox as shown in [Figure 10–18](#).

**Figure 10–18 Create Java Fact from Raise Action Class**



6. Click **OK**.  
This adds the Raise Action fact type to the **Java Facts** table.

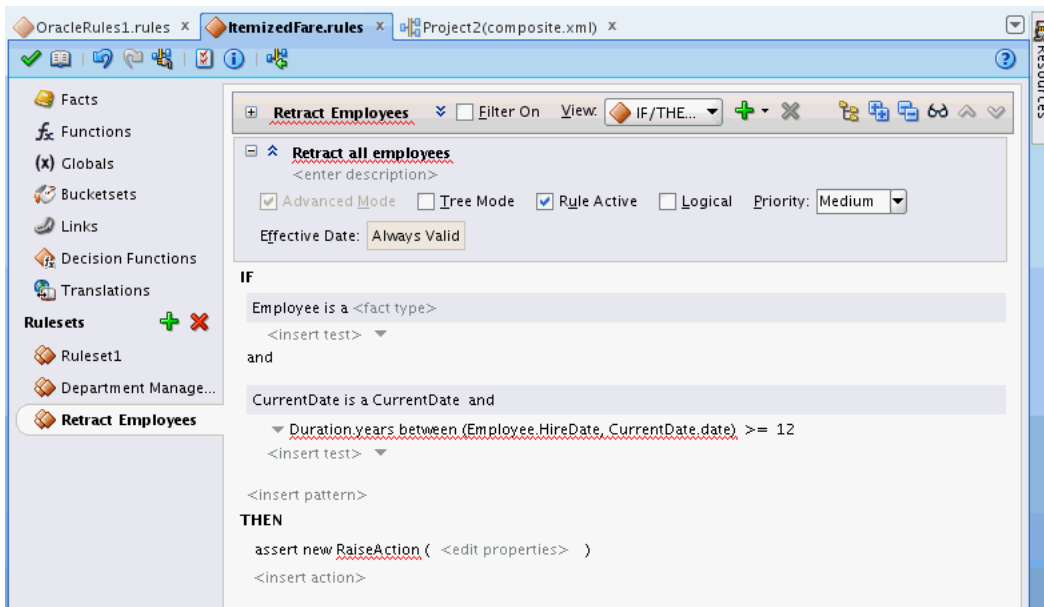
### 10.3.10.4 How to Add the 12 Year Raise Rule

This rule shows how to use action types to update database entries.

**To add 12 year raise rule:**

1. In Rules Designer in the Raises Ruleset, click **Create Rule**.
2. Change the rule name by selecting **Rule\_1** and entering the value: Longer than 12 years.
3. Click **Show Advanced Settings**. For more information, see [Section 4.5.1, "How to Show and Hide Advanced Settings in a Rule or Decision Table"](#).
4. Select **Advanced Mode**.
5. Enter the 12 year raise rules, as shown in [Figure 10–19](#).

**Figure 10–19 Adding the Longer Than 12 Years Rule to the Raises Ruleset**



### 10.3.10.5 How to Add the Employee Raises Decision Function

Now create the decision function for the employee raises and the retract all employees rulesets.

**To add a decision function:**

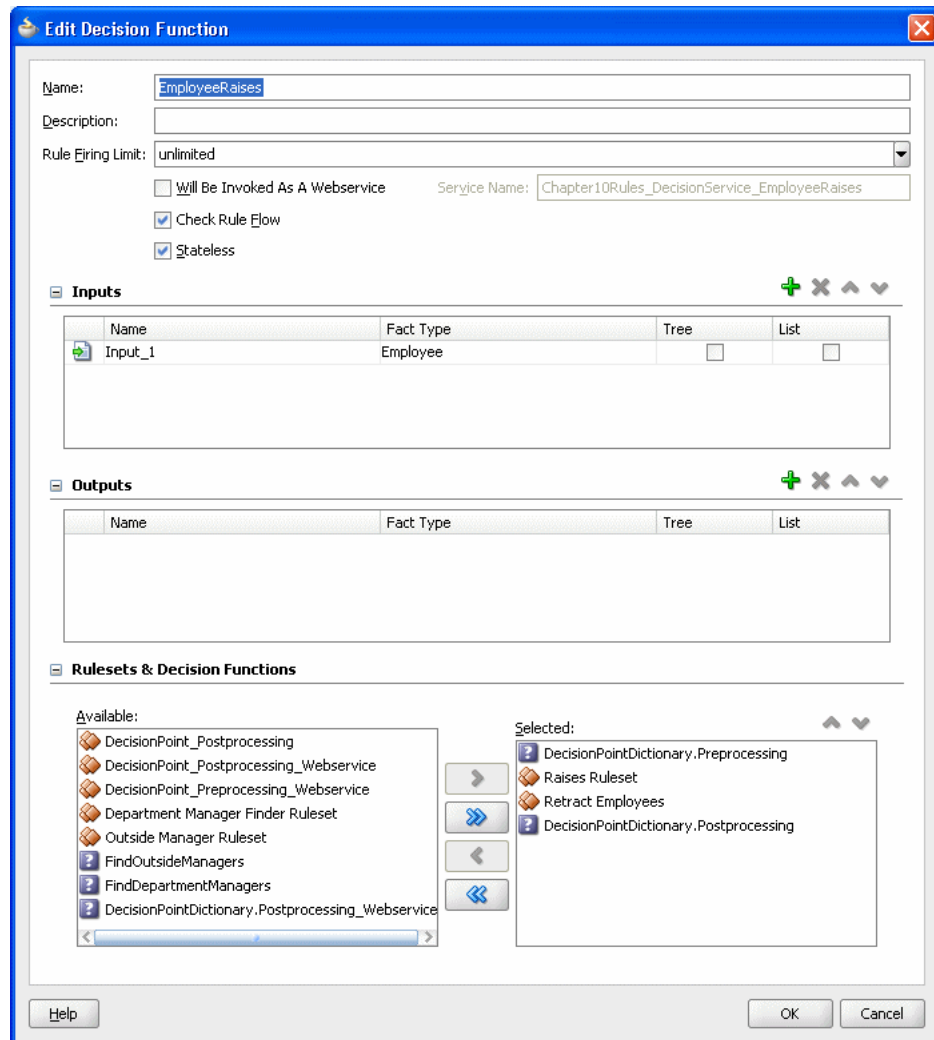
1. Click the **Decision Functions** navigation tab.
2. In the Decision Functions area, click **Create...** This displays the Edit Decision Function dialog.
3. Update the decision function fields as shown in [Figure 10–20](#).
  - Enter **Name** value EmployeeRaises.
  - In the **Inputs** area, click the **Add Input** and edit the input information as follows:
    - Click the **Fact Type** field and select **Employee** from the list.

In this decision function you do not define any outputs, because you use the `ActionType` API for taking action rather than producing output.



- In the **Rulesets & Decision Functions** area, move the following items from the **Available** area to the **Selected** area, in the specified order.
  - **DecisionPointDictionary.Preprocessing**
  - **Raises Ruleset**
  - **Retract Employees Ruleset**
  - **DecisionPointDictionary.Postprocessing**

**Figure 10–20 Adding the Employee Raises Decision Function**



4. Ensure that the items in the **Selected** area are in the order shown in [Figure 10–20](#). If they are not, select an item and use the **Move Up** and **Move Down** buttons to correct the order.
5. Click **OK**.

### 10.3.10.6 How to Add the Employee Raises Java Class

Add the employee raises class. This executes the decision function.

**To add the employee raises class:**

1. Select the **Chapter10** project.
2. Right-click and select **New...**
3. In the New Gallery, in the **Categories** area select **General**.
4. In the New Gallery, in the **Items** area, select **Java Class**.
5. Click **OK**.
6. In the **Name** field, enter `EmployeeRaises`.
7. Click **OK**.
8. Replace the contents of this class with the code shown in [Example 10–11](#).

**Example 10–11 DeptManagerFinder Class**

```
package com.example;

import oracle.jbo.ApplicationModule;
import oracle.jbo.ViewObject;
import oracle.jbo.client.Configuration;
import oracle.jbo.server.DBTransactionImpl2;

import oracle.rules.rl.exceptions.RLException;
import oracle.rules.sdk2.decisionpoint.DecisionPoint;
import oracle.rules.sdk2.decisionpoint.DecisionPointBuilder;
import oracle.rules.sdk2.decisionpoint.DecisionPointInstance;
import oracle.rules.sdk2.exception.SDKException;
import oracle.rules.sdk2.repository.DictionaryFQN;

public class EmployeeRaises {
    private static final String AM_DEF = "com.example.AppModule";
    private static final String CONFIG = "AppModuleLocal";
    private static final String VO_NAME = "EmployeesView1";
    private static final String DF_NAME = "EmployeeRaises";

    private static final DictionaryFQN DICT_FQN =
        new DictionaryFQN("com.example", "Chapter10Rules");

    private DecisionPoint dp = null;

    public EmployeeRaises() {
        try {
            dp = new DecisionPointBuilder()
                .with(DICT_FQN)
                .with(DF_NAME)
                .build();
        } catch (SDKException e) {
            System.err.println(e);
        }
    }

    public void run() {
        final ApplicationModule am =
            Configuration.createRootApplicationModule(AM_DEF, CONFIG);
        final ViewObject vo = am.findViewObject(VO_NAME);
        final DecisionPointInstance point = dp.getInstance();
    }
}
```

```

        point.setTransaction((DBTransactionImpl2)am.getTransaction());
        point.setAutoCommit(true);
        point.setViewObject(vo);
        try {
            point.invoke();
        } catch (RLEException e) {
            System.err.println(e);
        } catch (SDKException e) {
            System.err.println(e);
        }
    }

    for (DecisionPoint.NamedValue result : point.getResults()){
        System.out.println(result.getName() + " " + result.getValue());
    }
}

public static void main(String[] args) {
    new EmployeeRaises().run();
}
}

```

### 10.3.10.7 How to Copy Dictionary

Copy the updated dictionary to the MDS accessible location.

#### Copy dictionary to MDS accessible location:

1. In a file system navigator, outside of Oracle JDeveloper, navigate to the **Chapter10** folder and the **Chapter10** project and copy the **oracle** directory that contains the dictionary.
2. In the application directory for **Chapter10**, above the **Chapter10** project, navigate to the **.adf** directory.
3. Copy the **oracle** folder to this directory.

### 10.3.10.8 How to Build and Run the Project to Check the Raises Rule

You can build and test the project by running employee raises ruleset.

#### Build the project:

1. From the dropdown menu next to **Run** icon, select **Manage Run Configurations...**
2. In the Project Properties dialog, click **New...**
3. In the Create Run Configuration dialog, enter the name. For example, enter **EmployeeRaises**.
4. In the Copy Settings From field, enter **Default**.
5. Click **OK**.
6. With **EmployeeRaises** selected, click **Edit...**
7. In the **Default Run Target** field, click **Browse...**
8. Select **EmployeeRaises.java** from the `src\com\example` folder.
9. Click **Open**.
10. In the Edit Run Configuration dialog, click **OK**.

11. In the Project Properties dialog, click **OK**.

**Run the project:**

1. In the menu, next to the **Run** project icon, select **EmployeeRaises**.
2. Oracle JDeveloper displays the output as shown in [Example 10–12](#).

**Example 10–12 Output from Raises Ruleset**

```
raise for 100 0.03=>81.7
raise for 101 0.03=>1872.46
raise for 102 0.03=>60596.78
raise for 103 0.03=>31146.26
raise for 104 0.03=>20159.43
raise for 108 0.03=>35822.68
raise for 109 0.03=>26084.5
raise for 114 0.03=>27500.92
raise for 115 0.03=>7524.5
raise for 120 0.03=>16262.34
raise for 121 0.03=>16183.41
raise for 122 0.03=>15591.35
raise for 131 0.03=>3671.33
raise for 133 0.03=>4567.98
raise for 137 0.03=>4838.1
raise for 141 0.03=>4703.71
raise for 142 0.03=>4044.79
raise for 145 0.03=>17734.79
raise for 146 0.03=>17101.39
raise for 147 0.03=>15201.23
raise for 150 0.03=>12667.7
raise for 151 0.03=>12034.32
raise for 156 0.03=>13047.73
raise for 157 0.03=>12395.35
raise for 158 0.03=>11400.93
raise for 159 0.03=>10134.16
raise for 168 0.03=>14567.86
raise for 174 0.03=>13934.48
raise for 175 0.03=>11147.58
raise for 184 0.03=>5480.03
raise for 185 0.03=>5193.76
raise for 192 0.03=>5219.1
raise for 193 0.03=>4940.41
raise for 200 0.03=>5740.99
raise for 201 0.03=>16962.05
raise for 203 0.03=>8481.03
raise for 204 0.03=>13047.73
raise for 205 0.03=>15657.27
raise for 206 0.03=>10829.62
```

---

# Working with Decision Components in SOA Applications

This chapter discusses the Decision components that support Oracle Business Rules. It also covers how to use a Decision component as a mechanism for publishing rules and rulesets as a reusable service that can be invoked from multiple business processes.

A Decision Component is a SCA component that can be used within a composite and wired to a BPEL component. Apart from that, Decision Components are used for dynamic routing capability of Mediator and Advanced Routing Rules in Human Workflow.

This chapter includes the following sections:

- [Section 11.1, "Introduction to Decision Components"](#)
- [Section 11.2, "Working with a Decision Component"](#)
- [Section 11.3, "Decision Service Architecture"](#)

## 11.1 Introduction to Decision Components

A Decision component is a Web service that wraps a rule session to the underlying decision function.

A Decision component consists of the following:

- Rules or Decision Tables that are evaluated using the Rules Engine. These are defined using Rules Designer and stored in a business rules dictionary.
- Metadata that describes facts required for specific rules to be evaluated. Each ruleset that contains rules or Decision Tables is exposed as a service with facts that are input and output. These facts must be exposed through XSD definitions.

For example, a credit rating ruleset may expect a customer ID and previous loan history as facts, but a pension payment ruleset may expect a value with the years of employee service, salary, and age as facts.

For more information, see [Section 11.2.1, "Working with Decision Component Metadata"](#).

- A Web service wraps the input, output, and the call to the underlying rule engine.

This service lets business processes assert and retract facts as part of the process. In some cases, all facts can be asserted from the business process as one unit. In other cases, the business process can incrementally assert facts and eventually consult the rule engine for inferences. Therefore, the service has to support both stateless and stateful interactions.

You can create a variety of such business rules service components.

For more information, see *Developing SOA Applications with Oracle SOA Suite*.

## 11.2 Working with a Decision Component

Using Oracle JDeveloper with Rules Designer these tools automatically generate all required metadata and WSDL operations. The Decision component can be integrated into a SOA composite application in the following ways:

- Create a Decision component as a standalone component in the SOA Composite Editor. In this scenario, the Decision Service is exposed on the composite level and thus can be invoked from any Web service client.

For more information, see "Getting Started with Oracle Business Rules" in the *Developing SOA Applications with Oracle SOA Suite*.

- Create a Decision component in the SOA Composite Editor that you later associate with a BPEL process. In this scenario the Decision Service is not exposed on the composite level. However it can be wired to any other component within the composite, such as BPEL, Oracle Mediator, and Oracle Human Workflow.

For more information, see "Getting Started with Oracle Business Rules" in the *Developing SOA Applications with Oracle SOA Suite*.

- Create a Decision component within the Human Task editor of a human task component.

This integration provides the following benefits:

- Dynamic processing: provides for intelligent routing, validation of policies within a process, and constraint checks.
- Integration with ad hoc human tasks: provides policy-based task assignment, various escalation policies, and load balancing of tasks.

### 11.2.1 Working with Decision Component Metadata

A Decision component is defined by the following files:

- [Decision Service Metadata \(.decs\) File](#)
- [SCA Component Type \(.componentType\) File](#)
- [Decision Component Entry in composite.xml](#)

Typically, Oracle JDeveloper generates and maintains these files.

#### 11.2.1.1 Decision Service Metadata (.decs) File

Every Decision component within a composite comprises one business rule metadata file. The business rule metadata file provides information about the location of the component business rule dictionary and the Decision Services exposed by the Decision component.

One Decision component might expose one or more Decision Services. For example a CreditRating Decision component might expose two services, CheckEligibility and CalculateCreditRating.

In Oracle Fusion Middleware 11g Release 1 (11.1.1), the Decision Service metadata comprises the decision function name that is being exposed as a Web service. For projects that are migrated from older releases of Oracle SOA Suite, the Decision

Service metadata typically has more information depending on the interaction pattern used in 10.1.3.x.

The business rule metadata file (*business\_rule\_name.decs*) defines the contract between the components involved in the interaction of the business rule with the design time and back-end Oracle Rules Engine.

This file is in the **SOA Content** area of the Application Navigator in Oracle JDeveloper for your SOA composite application. [Table 11–1](#) describes the top-level elements in the Decision service .decs file.

**Table 11–1 Decision Metadata File (.decs) Top-level Elements**

Element	Description
ruleEngineProvider	<p>The <i>business_rule_name.decs</i> file <code>ruleEngineProvider</code> element includes details about the rule dictionary to use:</p> <pre>&lt;ruleEngineProvider name="OracleRulesSDK" provider="Oracle_11.0.0.0.0"&gt;   &lt;repository type="SCA-Archive"&gt;     &lt;path&gt;AutoLoanComposite/oracle/rules/AutoLoanRules.rules&lt;/path&gt;   &lt;/repository&gt; &lt;/ruleEngineProvider&gt;</pre> <p>The repository type is set to <code>SCA-Archive</code> for Decision components. This indicates that the rule dictionary is located in the service component architecture archive. The path is relative and interpreted differently by the following:</p> <ul style="list-style-type: none"> <li>Design time — The path is prefixed with <code>Oramds:/. Metadata service (MDS) APIs</code> open the rule dictionary. Therefore, the full path to the dictionary is as follows: <code>Oramds:/AutoLoanComposite/oracle/rules/AutoLoanRules.rules</code></li> <li>Runtime (business rule service engine) — The business rule service engine uses the Oracle Business Rules SDK <code>RuleRepository</code> API to open the rule dictionary located in MDS. The composite name prefix, for example (<code>AutoLoanComposite</code>) is removed from the path and the metadata manager assumes the existence of <code>oracle/rules/AutoLoanRules.rules</code> relative to the composite home directory.</li> </ul>
decisionService	<p>A Decision service is a Web service (or SOA) enabler of business rules. It is a service in the sense of a Web service, thus opening the world of business rules to service-oriented architectures (SOA). In 11g Release 1 (11.1.1.9), a Decision service consists of metadata and a WSDL contract for the service.</p> <p>The <i>business_rule_name.decs</i> file <code>decisionService</code> element defines the metadata that describes business rules exposed as a Web service.</p> <p>In general, a Decision service includes the following elements:</p> <ul style="list-style-type: none"> <li>Target namespace</li> <li>Reference to the back-end Oracle Rules Engine (this is the link to the rule dictionary). Note that <code>OracleRulesSDK</code> is the reference name that matches the name of the Oracle Rules Engine provider in <code>ruleEngineProvider</code> element.</li> <li>Name (<code>CreditRatingService</code> in the following example)</li> <li>Additional information about the dictionary name and ruleset to use</li> <li>List of supported operations (patterns)</li> </ul> <p>Apart from the operations (patterns), the parameter types (or fact types) of operations are specified (and validated later at runtime). Therefore, every Decision service exposes a strongly-typed contract.</p>

### 11.2.1.2 SCA Component Type (.componentType) File

An SCA *business\_rule\_name.componentType* file is included with each Decision component. This file lists the services exposed by the business rules service

component. In the following sample, two services are exposed: `CreditRatingService` and `LoanAdvisorService`.

```
<?xml version="1.0" encoding="UTF-8" ?>
<!-- Generated by Oracle SOA Modeler version 1.0 at [5/24/07 9:27 AM]. -->
<componentType xmlns="http://xmlns.oracle.com/sca/1.0">
  <service name="CreditRatingService">
    <interface.wSDL
interface="http://xmlns.oracle.com/creditrating/Rating#wsdl.interface(IDecisionSer
vice)"/>
  </service>
  <service name="LoanAdvisorService">
    <interface.wSDL
interface="http://xmlns.oracle.com/loanoffer/Advisor#wsdl.interface(IDecisionServi
ce)"/>
  </service>
</componentType>
```

### 11.2.1.3 Decision Component Entry in `composite.xml`

An entry in `composite.xml` is created for a decision component. For example,

```
<component name="OracleRules1">
  <implementation.decision src="OracleRules1.decs"/>
</component>
```

The business rules service engine uses the information from this implementation type to process requests for the Service Engine. From an SCA perspective, a Decision Component is a new "implementation type".

## 11.2.2 Working with Decision Components that Expose a Decision Function

You can use a Decision service to expose an Oracle Business Rules Decision Function as a service. A decision function is a function that is configured declaratively, without using RL Language programming that you use to call rules from a Java EE application or from a BPEL process.

[Example 11-1](#) shows a `business_rule_name.decs` file `decisionServices` element that defines the metadata for an Oracle Business Rules Decision Function exposed as a service.

### **Example 11-1** *decisionService for Decision Function Execution*

```
<?xml version="1.0" encoding="UTF-8" standalone="yes"?>
<decisionServices xmlns="http://xmlns.oracle.com/bpel/rules" name="PurchaseItems">
  <ruleEngineProvider name="OracleRulesSDK" provider="Oracle_11.0.0.0.0">
    <repository type="SCA-Archive">
      <path>PurchasingSampleProject/oracle/rules/com/example/PurchaseItems.rules</path>
    </repository>
  </ruleEngineProvider>
  <decisionService targetNamespace="http://xmlns.oracle.com/PurchaseItems/PurchaseItems_
DecisionService_ValidatePurchasesDF"
ruleEngineProviderReference="OracleRulesSDK" name="PurchaseItems_DecisionService_
ValidatePurchasesDF">
    <catalog>PurchaseItems</catalog>
    <pattern name="CallFunctionStateless">
      <arguments>
        <call>com.example.PurchaseItems.ValidatePurchasesDF</call>
      </arguments>
    </pattern>
    <pattern name="CallFunctionStateful">
      <arguments>
        <call>com.example.PurchaseItems.ValidatePurchasesDF</call>
      </arguments>
```



```

        </pattern>
    </decisionService>
</decisionServices>

```

In this case, the decision function `ValidatePurchasesDF` itself is specified entirely in the `PurchaseItems.rules` file.

For more information, see, [Chapter 6, "Working with Decision Functions"](#).

### 11.2.3 Using Stateful Interactions with a Decision Component

To provide a stateful Decision service you create a decision function and specify that the decision function is not stateless. To do so you deselect the **Stateless** checkbox in a decision function.

Note the following details about stateful interactions with a decision component (also see [Figure 11-2](#)):

- Rule sessions from the cache and those from the pool are mutually exclusive:
  - The rule session pool is for simple, stateless interactions only
  - The rule session cache keeps the state of a rule session across Decision service requests

### 11.2.4 What You Need to Know About Stateful Interactions with Decision Components

A Decision Component running in a Business Rules service engine supports either stateful or stateless operation. The **Reset Session** (stateless) checkbox in the Create Business Rules dialog provides support for these two modes of operation.

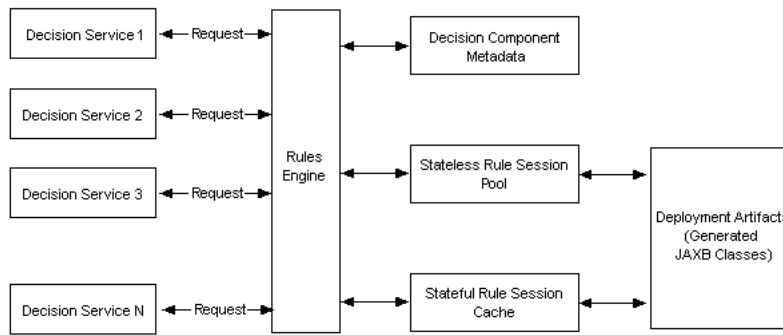
When the **Reset Session** (stateless) checkbox selected, this indicates stateless operation.

When **Reset Session** (stateless) checkbox is unselected, the underlying Oracle Business Rules object is kept in memory of the Business Rules service engine at a separate location (so that it is not given back to the Rule Session Pool when the operation is finished). Only use stateful operation if you know you need this option (some errors can occur at runtime when using stateful operation and these errors could use a significant amount of service engine memory).

When **Reset Session** (stateless) checkbox is unselected, a subsequent use of the Decision component reuses the cached `RuleSession` object, with all its state information from the `callFunctionStateful` invocation, and then releases it back to the Rule Session pool after the `callFunctionStateless` operation is finished.

## 11.3 Decision Service Architecture

A Decision service consists only of the service description. All other artifacts are shared within a decision component as shown in [Figure 11-1](#).

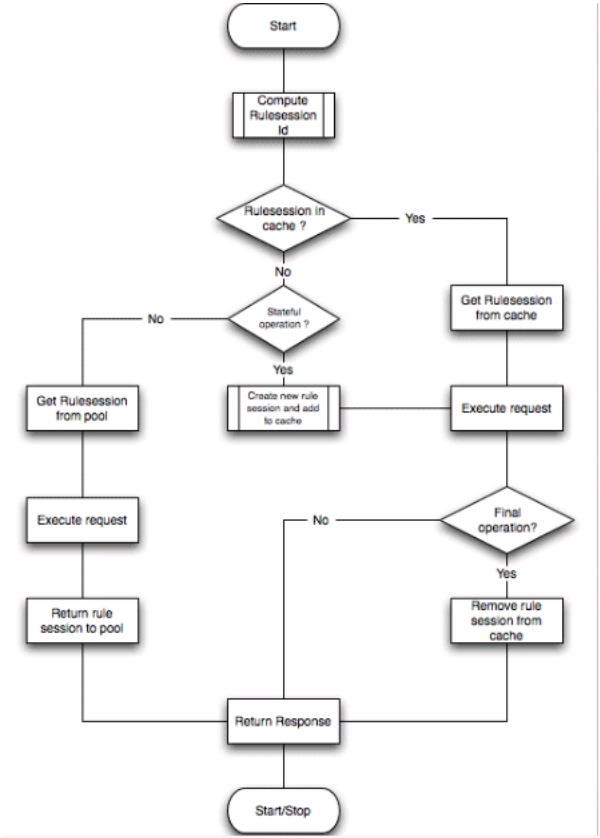
**Figure 11–1 Decision Service Architecture**

The heart of runtime is the Decision service cache, which is organized in a tree structure. Every decision component owns a subtree of that cache (depending on the composite distinguished name (DN), component, and service name). In this regard, Decision services of a decision component share the following data:

- Metadata of the decision component
  - Fact type metadata
  - Function metadata
  - Ruleset metadata
- Rule session pool
  - One rule session pool is created per decision component
  - The rule sessions in the pool are pre-initialized with the data model Oracle RL and the ruleset Oracle RL already executed
  - New rule sessions are created on demand
  - Rule sessions can be reused for a configurable number of times
  - The initial size of the rule session pool is configurable
- Stateful rule session cache
  - A special cache is maintained for stateful rule sessions.  
For more information, see [Section 11.2.3, "Using Stateful Interactions with a Decision Component"](#).
- Deployment artifacts
  - Decision component deployment can end up in class generation for JAXB fact types. The classes can be shared across the composite.

[Figure 11–2](#) shows how both stateless and stateful rule sessions interact with the rule session pool and how stateful rule sessions interact with the stateful rule session cache during a Decision service request.

Figure 11-2 Stateless and Stateful Rule Session Usage for a Decision Service Request





---

---

## Using Oracle SOA Composer with Oracle Business Rules

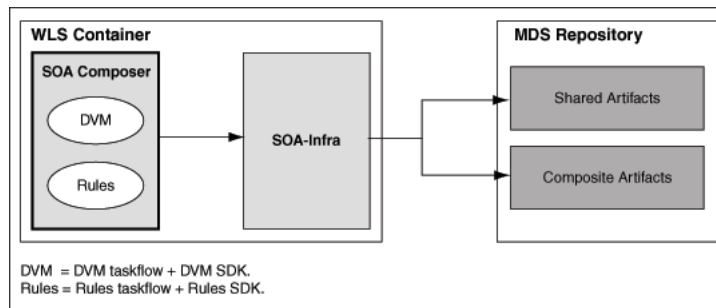
This chapter describes how to use the Oracle SOA Composer application (Oracle SOA Composer) to work with a deployed dictionary and tasks that are part of a SOA composite application at runtime.

The chapter includes the following sections:

- Section 12.1, "Introduction to Oracle SOA Composer"
- Section 12.2, "Using Oracle SOA Composer User Authentication"
- Section 12.3, "Enabling Accessibility Features in SOA Composer"
- Section 12.4, "Opening and Viewing an Oracle Business Rules Dictionary at Runtime"
- Section 12.5, "Getting Started with Editing and Saving a Dictionary at Runtime"
- Section 12.6, "Editing Rules in an Oracle Business Rules Dictionary at Runtime"
- Section 12.7, "Using the Oracle SOA Composer Browser Windows"
- Section 12.8, "Editing Decision Tables in an Oracle Business Rules Dictionary at Runtime"
- Section 12.9, "Localizing Names of Resources in Oracle Business Rules"
- Section 12.10, "Committing Changes for an Oracle Business Rules Dictionary at Runtime"
- Section 12.11, "Synchronizing Rules Dictionary in Oracle JDeveloper With Runtime Dictionary Updates"
- Section 12.12, "Validating an Oracle Business Rules Dictionary at Runtime"
- Section 12.13, "Obtaining Composite and Dictionary Information at Runtime"
- Section 12.14, "Working with Tasks at Runtime"

### 12.1 Introduction to Oracle SOA Composer

Oracle SOA Composer is a Web-based application that allows you to work with Oracle Business Rules dictionaries and tasks for deployed applications. [Figure 12–1](#) shows how Oracle SOA Composer accesses a dictionary or a task in an MDS repository.

**Figure 12–1 Oracle SOA Composer Architecture**

You can build accessibility into the applications while building them. For information on building applications for SOA composer see, [Chapter 9, "Creating a Rule-enabled Non-SOA Java EE Application"](#).

For information on how to develop accessible ADF Faces pages, see, "Developing Accessible ADF Faces Pages" in *Oracle Fusion Middleware Web User Interface Developer's Guide for Oracle Application Development Framework*.

## 12.2 Using Oracle SOA Composer User Authentication

[Figure 12–2](#) shows the Oracle SOA Composer login page. This page allows Oracle SOA Composer to authenticate the specified user.

**Figure 12–2 Oracle Oracle SOA Composer Login Page**

### To login to Oracle SOA Composer:

1. Access Oracle SOA Composer using the following URL in your browser address bar:

`http://SERVER_NAME_OR_IP_ADDRESS/soa/composer`

2. In the Oracle SOA Composer login page, in the **Username** field, enter a user name.
3. In the **Password** field, enter a password.
4. Click **Login**.

For information on creating and managing users and groups, see *Oracle WebLogic Server Administration Console Online Help*.

## 12.2.1 What You Need to Know About SOA Composer Access Control and User Authentication

Oracle SOA Composer supports user and password access control and only authenticated users can use Oracle SOA Composer. However, Oracle SOA Composer does not provide finer grained access control. For example, Oracle SOA Composer does not support access control for individual rulesets or rules within a dictionary.

Oracle SOA Composer does support access control to metadata. Using Oracle SOA Composer, only users with the SOADesigner application role can access the metadata from Oracle SOA Composer. By default all the users with the WLS Administrator privileges have this role.

If a user without the SOADesigner role logs into Oracle SOA Composer, a message is shown indicating the user is not authorized to modify the SOA metadata, as shown in [Figure 12-3](#).

**Figure 12-3 SOA Composer Unauthorized Metadata Access Message**



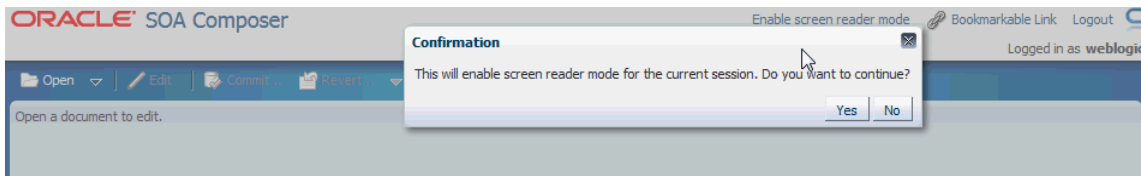
For more information on assigning the SOADesigner role to a nonadmin user who requires access to Oracle SOA Composer, see "Managing Application Roles in Oracle Enterprise Manager Fusion Middleware Control Console" in *Oracle Fusion Middleware Administrator's Guide for Oracle SOA Suite and Oracle Business Process Management Suite*.

## 12.3 Enabling Accessibility Features in SOA Composer

SOA Composer provides the screen reader option. This option enables your screen reader to access and read all components of the application.

To enable screen reader:

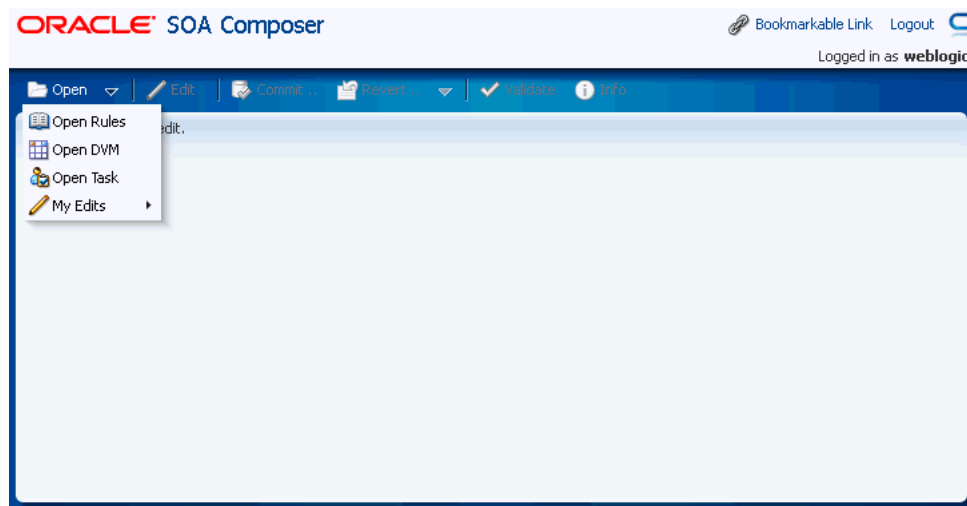
1. Click the **Enable screen reader mode** link on the top right corner.
2. A confirmation message, **This will enable screen reader mode for the current session. Do you want to continue?**, appears as shown in [Figure 12-4](#).

**Figure 12–4 Enable Screen Reader Confirmation Message**

3. Click **Yes** to confirm.

## 12.4 Opening and Viewing an Oracle Business Rules Dictionary at Runtime

After you login to Oracle SOA Composer you can select a document to open. Oracle SOA Composer supports viewing and editing different types of metadata, including a DVM document or an Oracle Business Rules dictionary. In Oracle SOA Composer, you can open either an Oracle Business Rules dictionary or a DVM file with the **Open** menu as shown in [Figure 12–5](#).

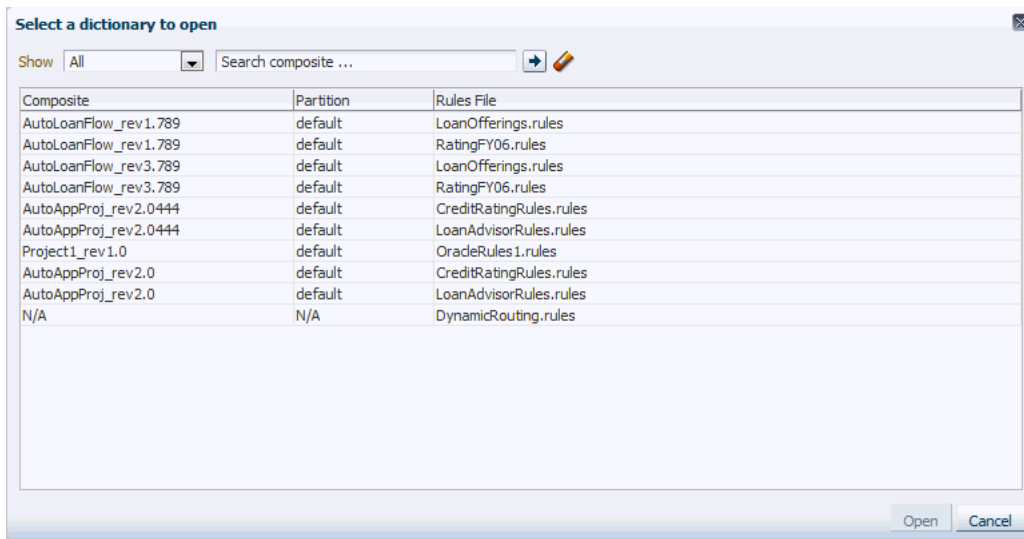
**Figure 12–5 Oracle SOA Composer Open Menu Options**

### 12.4.1 Opening an Oracle Business Rules Dictionary at Runtime

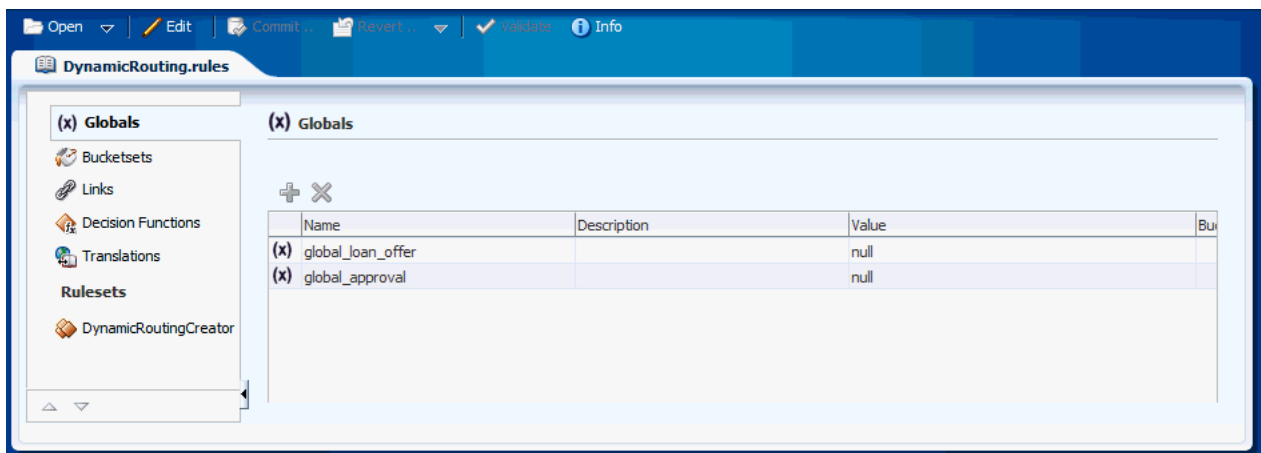
**To open an Oracle Business Rules dictionary using the Open menu:**

1. In Oracle SOA Composer, from the **Open** menu, select **Open Rules**.
2. When you select **Open Rules**, Oracle SOA Composer connects to MDS and displays the **Select a dictionary to open** dialog box. This dialog box presents the available composite applications that contain dictionaries, as shown in [Figure 12–6](#). In addition, it lists the shared dictionaries, and these shared dictionaries can also be viewed and edited.



**Figure 12–6 Oracle SOA Composer with Oracle Business Rules Dictionaries**

- To open a dictionary select an entry in the table and click **Open** or double-click an item. This opens the dictionary in view mode, as shown in [Figure 12–7](#).

**Figure 12–7 Oracle Business Rules Dictionary Open in Oracle SOA Composer View Mode**

As shown in [Figure 12–7](#), Oracle SOA Composer shows a dictionary that displays a left-side panel with a list of tabs and links. Dictionary details for the selected item are shown on the right-hand side. Oracle SOA Composer includes the following tabs:

- Globals
- Bucketsets
- Links
- Decision Functions
- Rulesets

---

**Note:** Functions are not supported in Oracle SOA Composer.

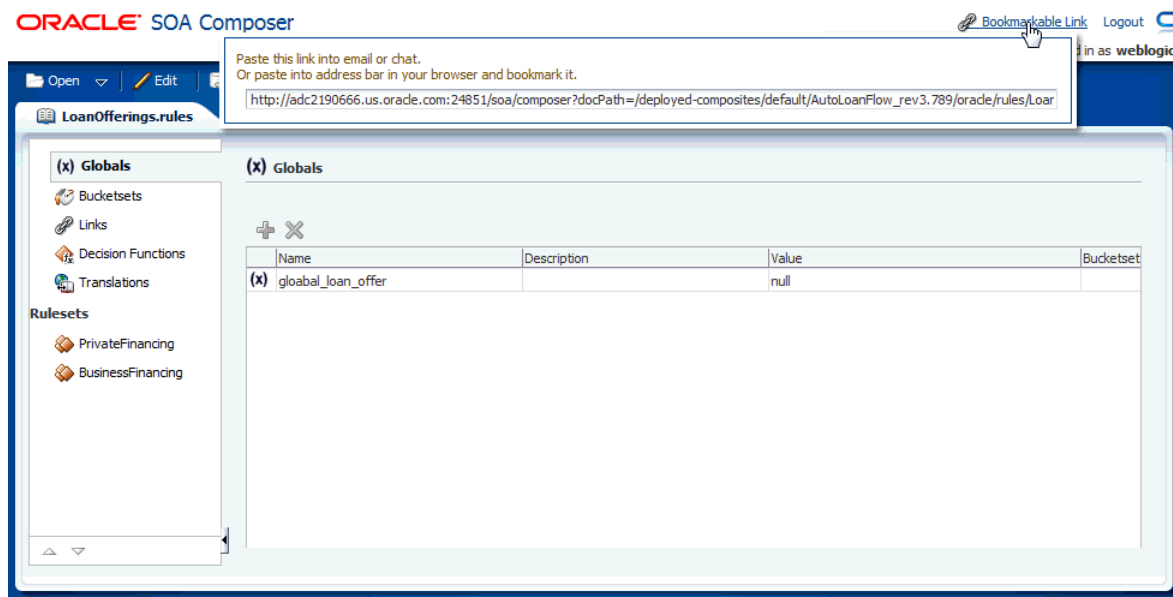
---

By default, a dictionary is opened in the view mode. If a dictionary is previously opened in the edit mode and the changes made, if any, are not reverted, the next time when you open it, Oracle SOA Composer opens the dictionary in the edit mode. For more information on Edit mode, see [Section 12.5, "Getting Started with Editing and Saving a Dictionary at Runtime"](#).

**To open an Oracle Business Rules dictionary directly using a known URL:**

1. Obtain the URL for a document that stores an Oracle Business Rules dictionary by using **Bookmarkable Link** in Oracle SOA Composer:
  - a. In an open dictionary, click **Bookmarkable Link** to obtain the URL information for the dictionary, as shown in [Figure 12–8](#).

**Figure 12–8 Using Link Dialog to Obtain the URL for an Open Dictionary**



- b. Copy the URL information and save it for future use.
2. In a browser, use the saved URL to directly access the dictionary.

For example,

```
http://SERVER_NAME_OR_IP_ADDRESS/soa/composer?docPath=/deployed-composites/default/BusinessRulesTest_rev1.0/oracle/rules/businessrulestest/OrderBooking.rules
```

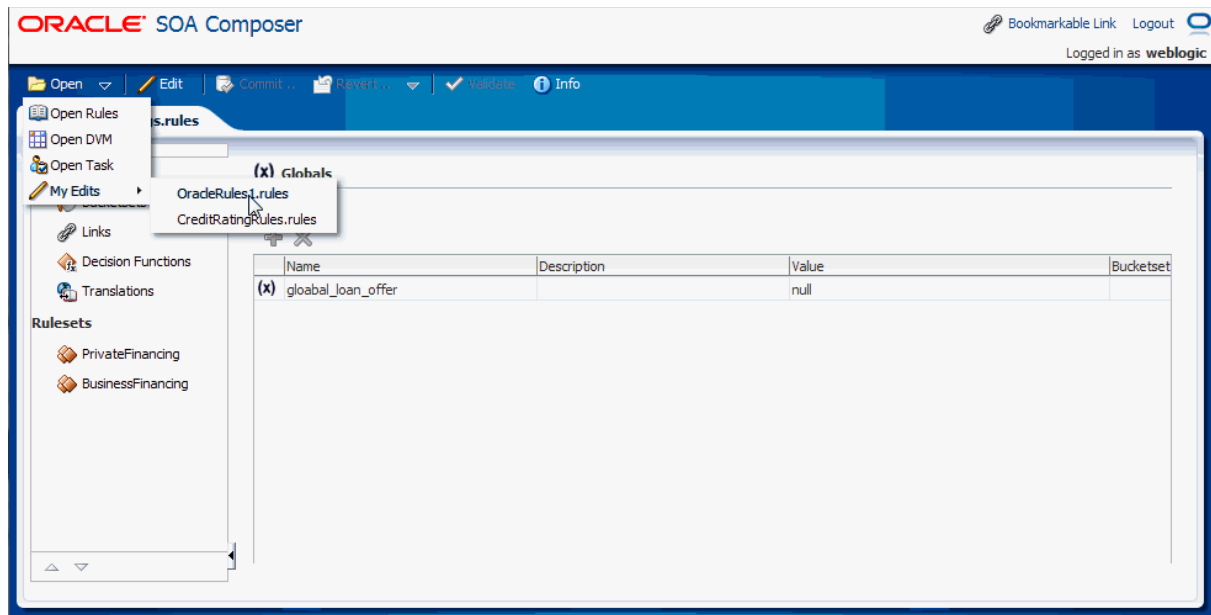
According to the preceding example, composites are stored as per the following structure: `deployed-composites/composite name_rev composite revision/oracle/rules/dictionary package path/dictionary name.rules`

**To open and edit a recently edited dictionary using the My Edits option:**

If you recently edited a dictionary, then you can use the **Open** menu **My Edits** option to open and edit a dictionary.

1. In Oracle SOA Composer, from the **Open** menu select **My Edits** and select a dictionary from the list, as shown in [Figure 12–9](#).

Figure 12–9 Using Open My Edits Option to Open a Dictionary

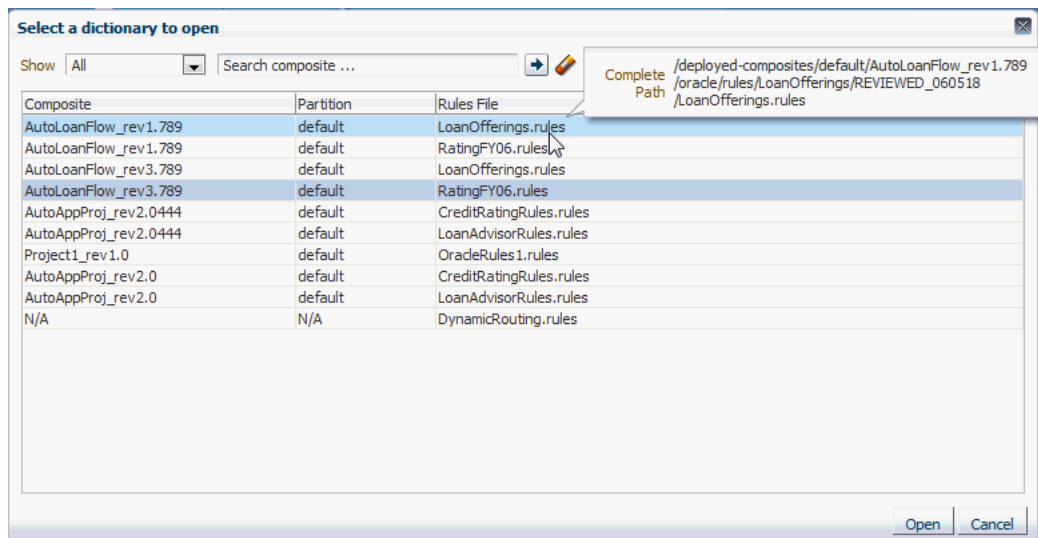


- Oracle SOA Composer opens the specified dictionary in edit mode.

## 12.4.2 What You Need to Know to Obtain the Dictionary Path from the Open Dialog

The Select a Dictionary to Open dialog includes a **Rules File** field. When you hold the mouse over the values in the **Rules File** field, Oracle SOA Composer shows a "Complete Path" popup that includes the dictionary path, as shown in Figure 12–10.

Figure 12–10 Showing the Dictionary Rules File Complete Path from the Open Dialog



## 12.4.3 How to View Globals in an Oracle Business Rules Dictionary at Runtime

When you open a dictionary Oracle SOA Composer displays the **Globals** tab. The **Globals** tab only shows final global variables (global variables with **Final** option selected). Final global variables from linked dictionaries are also displayed in the

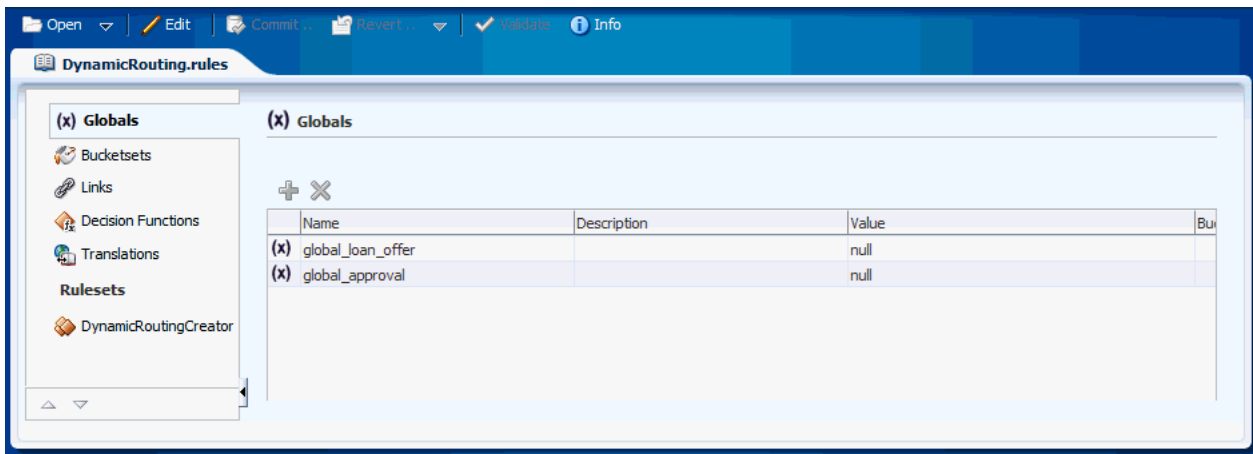
**Globals** tab. However, these linked global variables are not editable even in the edit mode.

You cannot create or delete global variables. From the **Globals** tab, in edit mode, you can edit the **Name**, **Description**, and **Value** fields. For the **Value** field, you can use the expression builder to set the value. To check for validity, you can click **Validate** button on the Oracle SOA Composer menu bar. In view mode, the edit operations are not available. For information on using the Oracle SOA Composer edit mode, see [Section 12.5, "Getting Started with Editing and Saving a Dictionary at Runtime"](#).

**To view globals in Oracle SOA Composer:**

1. In Oracle SOA Composer, from the **Open** menu, select **Open Rules**.
2. After you open a dictionary, select the **Globals** tab from the left-side pane. This displays the Globals table, as shown in [Figure 12–11](#).

**Figure 12–11 Using the Oracle SOA Composer Rules Dictionary Globals Tab**



#### 12.4.4 How to View Bucketsets in an Oracle Business Rules Dictionary at Runtime

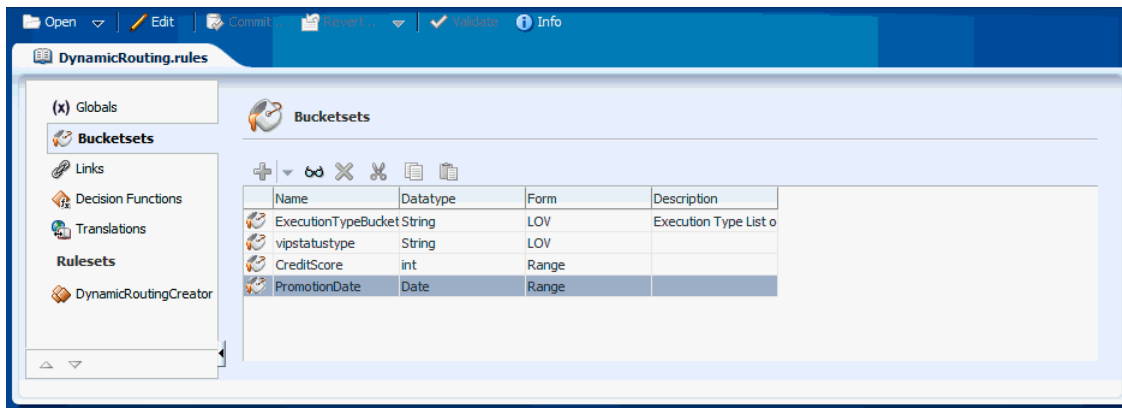
When you open a dictionary and select the **Bucketsets** tab, if the dictionary contains bucketsets, the table shows all the bucketsets. Bucketsets from linked dictionaries are also displayed in the Bucketsets table. You can select a linked bucketset and click the **Edit** button to view the buckets. However, a linked bucketset is not editable even in the edit mode.

For information on the Oracle SOA Composer edit mode, see [Section 12.5, "Getting Started with Editing and Saving a Dictionary at Runtime"](#).

**To view bucketsets in Oracle SOA Composer:**

1. In Oracle SOA Composer, from the **Open** menu select **Open Rules**.
2. After you open a dictionary, select the **Bucketsets** tab from the left-side pane. This displays the Bucketsets table, as shown in [Figure 12–12](#).

Figure 12–12 Using the Oracle SOA Composer Rules Dictionary Bucketsets Tab



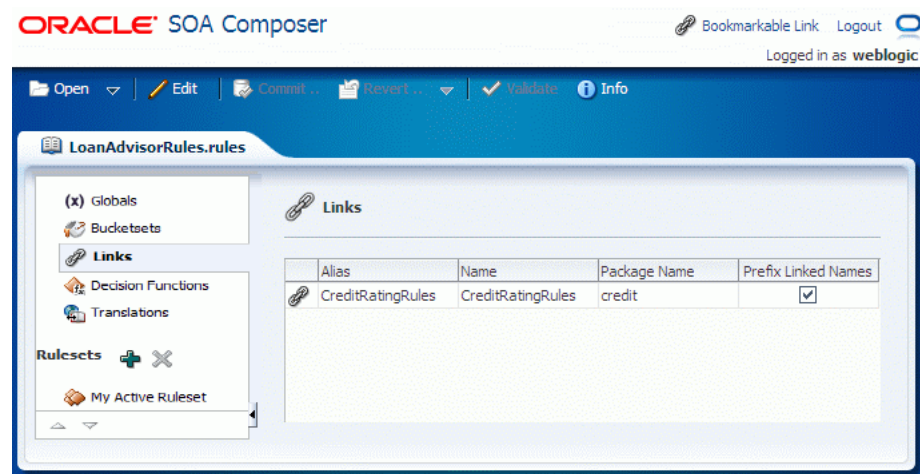
## 12.4.5 How to View Linked Dictionary Names at Runtime

In Oracle SOA Composer, you can view the names of the dictionaries to which the current dictionary is linked by using the **Links** tab on the left-side panel as shown in Figure 12–13. Currently, even in the edit mode, you can only view the linked dictionary names, but you cannot link to a dictionary or delete an existing link to any dictionary.

### To view linked dictionary names in Oracle SOA Composer:

1. In Oracle SOA Composer, from the **Open** menu, select **Open Rules**.
2. After you open a dictionary, select the **Links** tab from the left-side pane. This displays the Links table, as shown in Figure 12–13.

Figure 12–13 Viewing the Linked Dictionary Name



The Links table displays the name of the linked dictionaries, which in this case is CreditRatingRules.

## 12.4.6 How to View Decision Functions in Oracle Business Rules Dictionary at Runtime

In Oracle SOA Composer, you can view the decision functions that are available to the current dictionary by using the Decision Functions tab on the left-side panel as shown in Figure 12–14. Currently, even in the edit mode, you can only modify the following

fields and options:

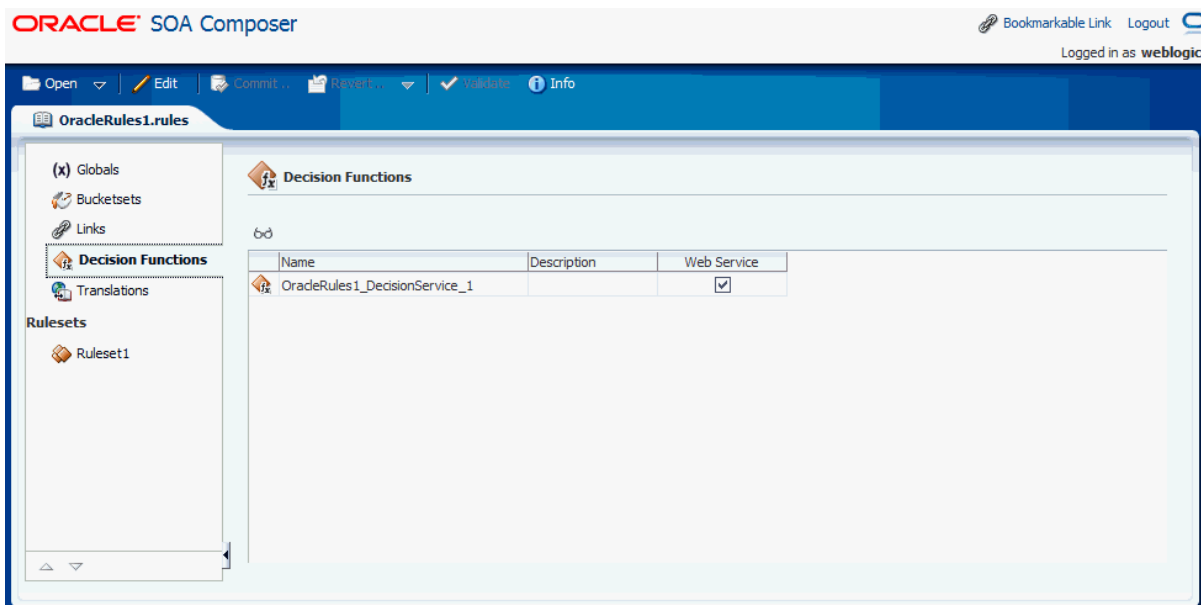
- Description
- Rule Firing Limit
- Check rule flow
- Make stateless
- Available Rulesets to fire

You cannot create any decision function, rename an existing decision function, or add or delete any input or output.

**To view decision function names in Oracle SOA Composer:**

1. In Oracle SOA Composer, from the **Open** menu, select **Open Rules**.
2. After you open a dictionary, select the **Decision Functions** tab from the left-side pane. This displays the Decision Functions table, as shown in [Figure 12–14](#).

**Figure 12–14 Viewing Decision Function Names**



The Decision Functions table displays the names of all the available decision functions, both parent and linked, which in this case are DecisionFunction\_0, and CreditRatingRules.DecisionFunction\_0.

### 12.4.7 How to View Rulesets in an Oracle Business Rules Dictionary at Runtime

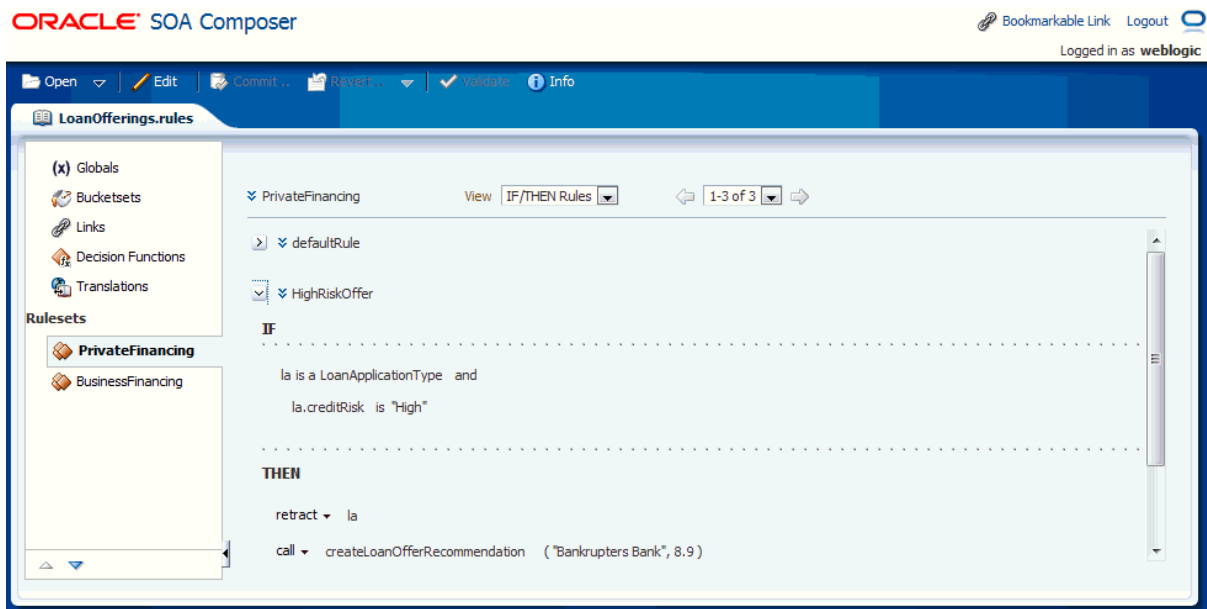
Oracle SOA Composer displays the rulesets in the dictionary on the left-side panel, as shown in [Figure 12–15](#). You can select a ruleset to display a detailed view of the ruleset. In view mode, all the rules in the ruleset are displayed but they are not editable. For information on the Oracle SOA Composer Edit mode, see [Section 12.5, "Getting Started with Editing and Saving a Dictionary at Runtime"](#).

---

**Note:** Using Oracle SOA Composer in edit mode, you cannot create or delete rulesets. You can view and modify rulesets.

---

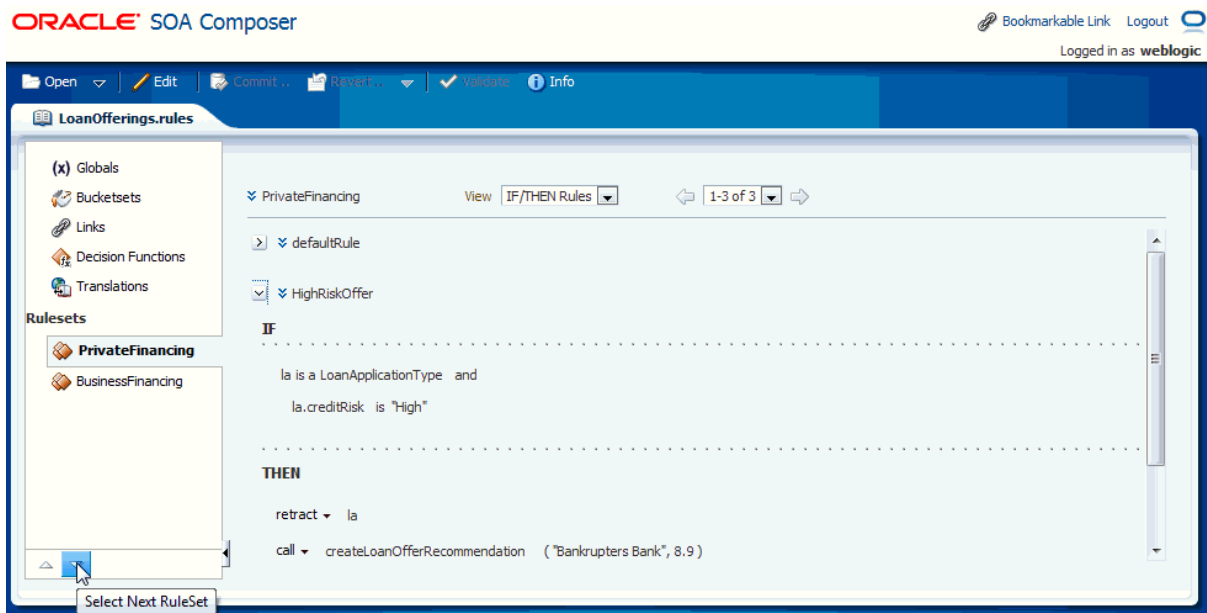
Figure 12–15 Using the Oracle SOA Composer Rules Dictionary Rulesets Tab to View Rules



**To select the next ruleset or previous ruleset:**

1. In Oracle SOA Composer, open a dictionary and select a ruleset.
2. When you are viewing a ruleset, you can click **Select Next Ruleset** or **Select Previous Ruleset** to view the next or the previous ruleset, as shown in Figure 12–16.

Figure 12–16 Using the Oracle SOA Composer Rules Dictionary Rulesets Tab to Select Next Ruleset



To add new Rulesets click on the **Add Ruleset** icon next to **Rulesets** in the left navigation menu. For more information on Rulesets, see [Chapter 4, "Working with Rulesets and Rules"](#).

## 12.5 Getting Started with Editing and Saving a Dictionary at Runtime

When you select and open a dictionary Oracle SOA Composer shows the dictionary in read only mode. From each tab in view mode, you enter edit mode for the dictionary item by selecting the **Edit** menu. In edit mode, after you make changes, click **Save** to save your changes. Saving changes saves the dictionary to a work area. To apply the changes to the runtime version of the dictionary, click **Commit**.

If you decide you do not want to apply the changes, you can revert the changes by selecting either of the following:

- Click **Revert** on the Oracle SOA Composer menu and then select **Clear all unsaved changes**.
- Click **Revert** on the SOA Composer menu and then select **Clear all session edits and saved changes**.

This clears only the unsaved changes.

This aborts all the changes done as part of the existing edit session.

When you edit a composite and redeploy it by overwriting the existing composite, the edit session is saved. When you reopen the dictionary, a dialog box opens in SOA Composer that asks you whether you want to revert to the previous edit session. Use the dialog box if you wish you revert to the previous edit session.

### 12.5.1 What You May Need to Know About Localized Number Formatting Support in Oracle SOA Composer

In Oracle SOA Composer, number formatting changes based on the browser locale. For example, you are using Oracle SOA Composer with U.S. English as the browser language. You enter a floating-point data, such as 34533223.2345, as a value. If you wish to view the data in any other language, such as French, you need to:

1. Modify the browser locale for the instance to French.
2. Click the **Refresh** button of the browser to view the number formatting changes

In French, the value should display as 34533223,2345.

---



---

**Note:** The grouping and decimal separators specified in Oracle SOA Composer overrides the locale-specific ones.

---



---

### 12.5.2 What You May Need to Know About Cutting/Copying and Pasting Rule Elements at Runtime

You can cut/copy a bucketset/rule from one dictionary and open another dictionary in composer and paste it. However, cut/copy/paste works between different dictionaries within the same session.

Cutting/copying and pasting feature enables you to quickly create a new rule element based on an existing one, without having to create the new element from scratch.

The icons in the [Figure 12–17](#) help you with cut, copy and paste options.

**Figure 12–17** *Cut, Copy and Paste Icons*





Oracle SOA Composer enables you to cut/copy and paste the following elements of a rule:

- Rules
- Patterns
- Conditions
- Actions
- Bucketsets

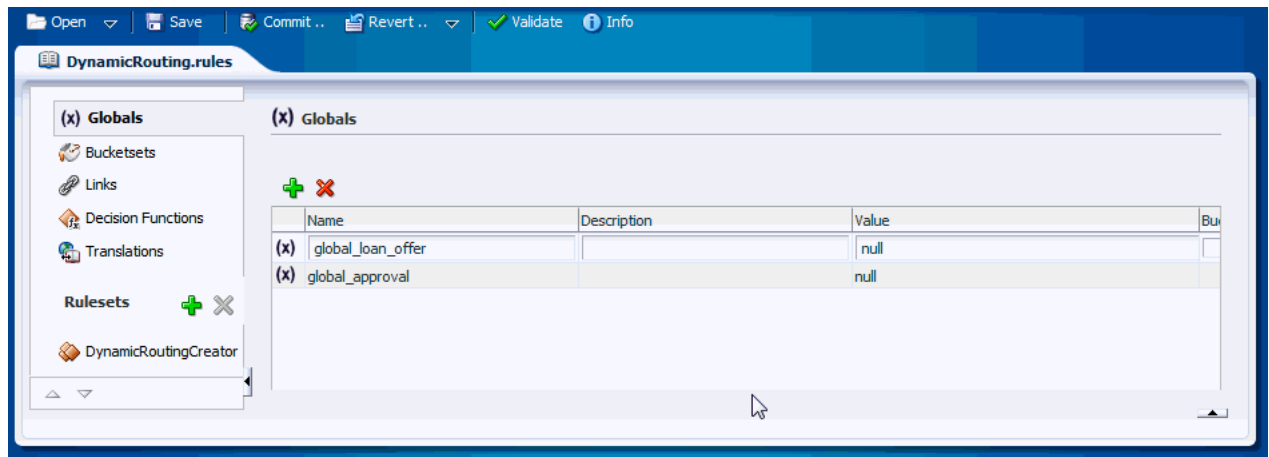
Cut/copy/paste is **not** supported for the following:

- Globals
- Links
- Buckets
- Decision Functions

### 12.5.3 How to Edit Globals in an Oracle Business Rules Dictionary at Runtime

In Oracle SOA Composer, selecting the **Globals** tab shows you a table listing the globals in the dictionary. To edit a global, select the appropriate row, and the entire row becomes editable. Make necessary changes as required.

**Figure 12–18** List of Globals in the Dictionary



To add a global, click the **Add Global** icon on the top. A new empty row is added. Make necessary changes to Name, Description, Value, Bucketset, Type, Final, Consent. For more information on adding globals, see [Section 2.3, "Working with Oracle Business Rules Globals"](#).

To delete a global, select a row and click the **Delete** icon.

### 12.5.4 How to Edit Bucketsets in an Oracle Business Rules Dictionary at Runtime

In Oracle SOA Composer, selecting the **Bucketsets** tab shows you a table listing the bucketsets in the dictionary. To edit a bucketset, select the appropriate row, and click the **Edit Bucketset** icon to display the Bucketset Editor. Depending on the type of the bucketset, Range, Enum, or LOV, this displays a corresponding Edit bucketset page.

You can create a Range Bucketset by clicking the **Add Bucketset** icon and selecting a type. This adds a new row in the Bucketsets table. For example, for Date types, such as Date, DateTime, or Time, a calendar is displayed for selecting the date, time, and timezone. Adding a bucket automatically adds an end point for a range bucket and a value for an LOV bucket based on the datatype. You can modify the newly added bucket end point or value. Note that the alias is modified when an end point or value is changed.

For more information on adding Bucketsets, see [Section 3.6, "Working with Bucketsets"](#) and [Section 3.7, "Associating a Bucketset with Business Terms"](#).

To cut or copy a bucket set, select a row and click **Cut** or **Copy**. To paste a copied bucket set, click **Paste**.

To delete a bucketset, select a row and click **Delete**.

#### To edit a Range Bucketset:

1. To edit a Range bucketset, in Oracle SOA Composer select the **Bucketsets** tab. This displays a table listing the bucketsets in the dictionary.
2. To edit a Range bucketset, select the appropriate Range bucketset row and click the **Edit Bucketset** icon. This displays the Bucketset Editor page, as shown in [Figure 12–19](#).

**Figure 12–19 Using Bucketset Editor to Edit a Range Bucketset**

Value	Alias	Allowed in Actions	Description
otherwise	otherwise	<input checked="" type="checkbox"/>	
Sep 9, 2011	Bucket 1	<input checked="" type="checkbox"/>	
Nov 29, 2011	Bucket 2	<input checked="" type="checkbox"/>	
Jun 12, 2012	Bucket 3	<input checked="" type="checkbox"/>	

3. Use the Bucketset Editor to edit the appropriate fields in the bucketset. You can click **Add Bucket** to add a bucket, and also select a row and click **Delete Bucket** to delete a bucket.
4. Click **OK** to confirm the changes.

**To edit an LOV Bucketset:**

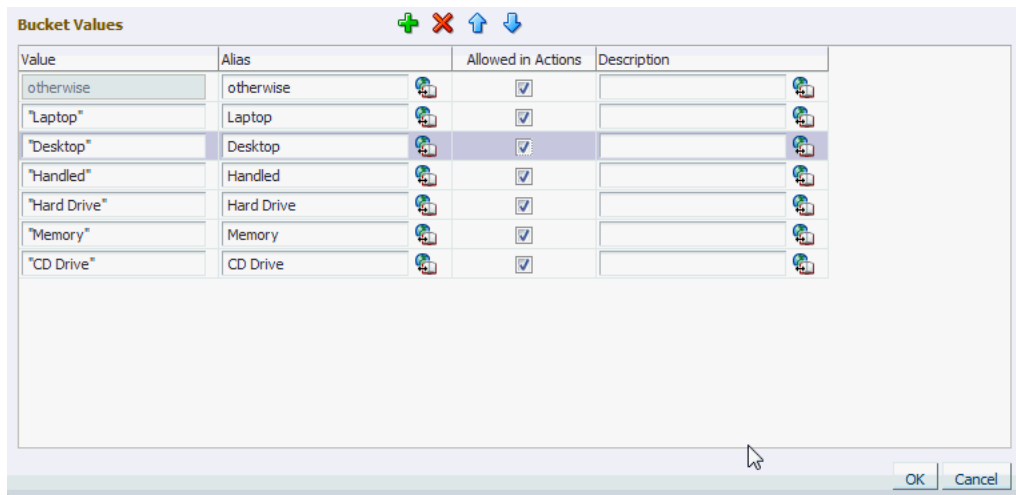
1. To edit an LOV bucketset, in Oracle SOA Composer select the **Bucketsets** tab. This displays a table listing the bucketsets in the dictionary.
2. To edit an LOV bucketset, select the appropriate LOV bucketset row and click the **Edit Bucketset** icon. This displays the Bucketset Editor page, as shown in [Figure 12–20](#).

**Figure 12–20 Bucketset Editor Dialog to Edit an LOV Bucketset**

Value	Alias	Allowed in Actions	Description
otherwise	otherwise	<input checked="" type="checkbox"/>	
"Laptop"	Laptop	<input checked="" type="checkbox"/>	
"Desktop"	Desktop	<input checked="" type="checkbox"/>	
"Handled"	Handled	<input checked="" type="checkbox"/>	
"Hard Drive"	Hard Drive	<input checked="" type="checkbox"/>	
"Memory"	Memory	<input checked="" type="checkbox"/>	
"CD Drive"	CD Drive	<input checked="" type="checkbox"/>	

3. Use the Bucketset Editor to edit the appropriate fields in the bucketset. You can click **Add Bucket** to add a bucket, and also select a row and click **Delete Bucket** to delete a bucket.
4. To change the order of buckets in the bucketset, select a bucket and then use the up or down arrow to move the selected bucket ([Figure 12–21](#)).

You can change the relative position of buckets in an LOV bucketset only; you cannot reorder buckets in a Range bucketset.

**Figure 12–21 Moving Buckets in a Bucketset to Change the Order of Values**

5. Click **OK** to confirm the changes.

### 12.5.5 What You Need to Know About Editing Bucketsets

Only when a bucket has the **Allowed in Actions** field selected does the bucketset display in the condition cell drop-down in a Decision Table.

Click **Validate** in the menu bar to validate the dictionary while making changes to a bucketset.

### 12.5.6 How to Work With Dictionary Links in an Oracle Business Rules Dictionary at Runtime

An Oracle Business Rules dictionary can be linked to other dictionaries. The complete data model defined by a dictionary and its linked dictionaries is called a combined dictionary. You can create multiple links to the same dictionary. However, in this case, all but the first link is ignored.

You cannot use Oracle SOA Composer to link dictionaries. However, if a deployed composite already has linked dictionaries, using Oracle SOA Composer, you can view the linked dictionary names and make use of the Globals, Bucketsets, and Rulesets of the linked dictionaries across applications. For example you have an application called App1 that contains a dictionary called Dict1. Dict1 is linked to another dictionary called Dict2. Because Dict1 is linked to Dict2, the objects of Dict2 will be available for use in App1.

For more information on viewing linked dictionary names, see [Section 12.4.5, "How to View Linked Dictionary Names at Runtime."](#)

In Oracle SOA Composer, in the edit mode, you can use the **Prefix Linked Names** checkbox in the Links table to either display or hide the linked dictionary name that is prefixed to the all the items in the dictionary such as Globals, Bucketsets, and Rulesets. Selecting the checkbox prefixes facts from the linked dictionary with its dictionary name, and deselecting hides the linked dictionary facts prefix. By default, the **Prefix Linked Names** checkbox is in selected state as shown in [Figure 12–22](#).

Figure 12–22 The Links Tab

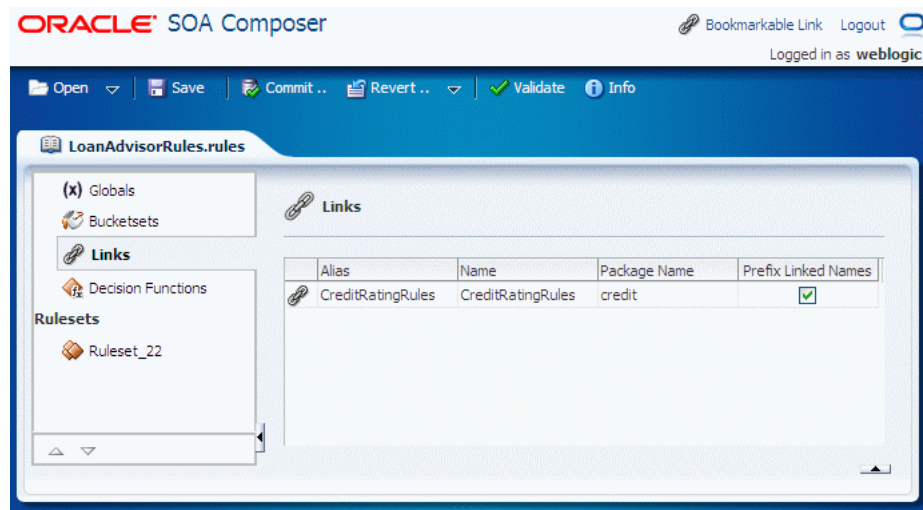


Figure 12–23 displays three bucketsets: Rating from the current dictionary and Bucketset\_1 and Bucketset\_2 from the base dictionary CreditRatingRules, which is prefixed to both Bucketset\_1 and Bucketset\_2.

Figure 12–23 Prefixed Linked Dictionary Name Displayed

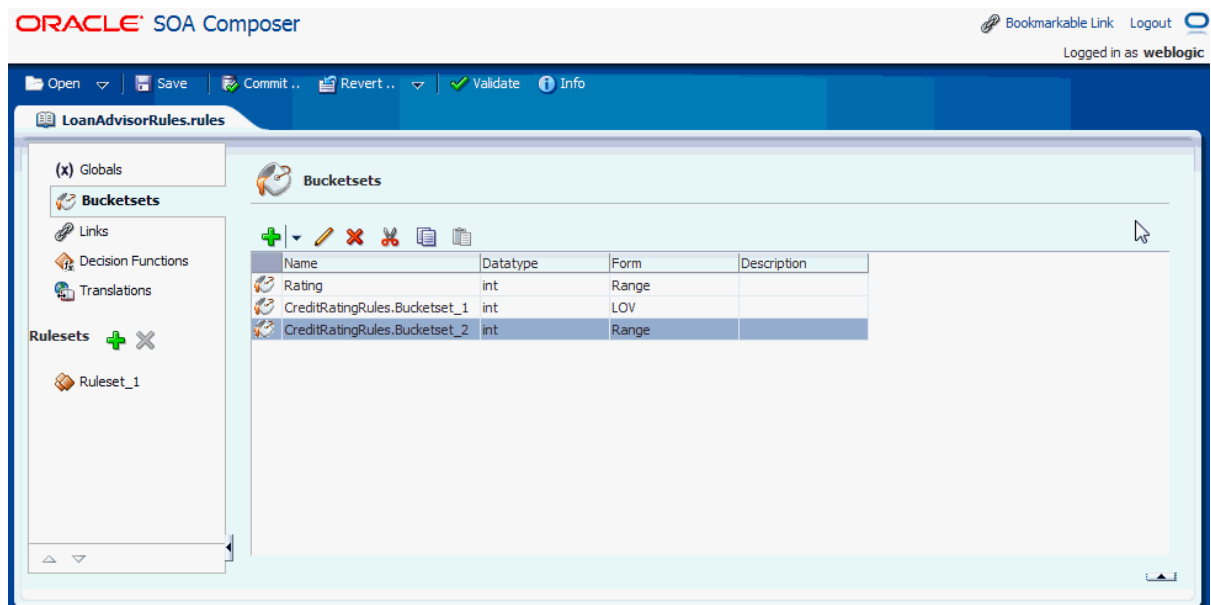
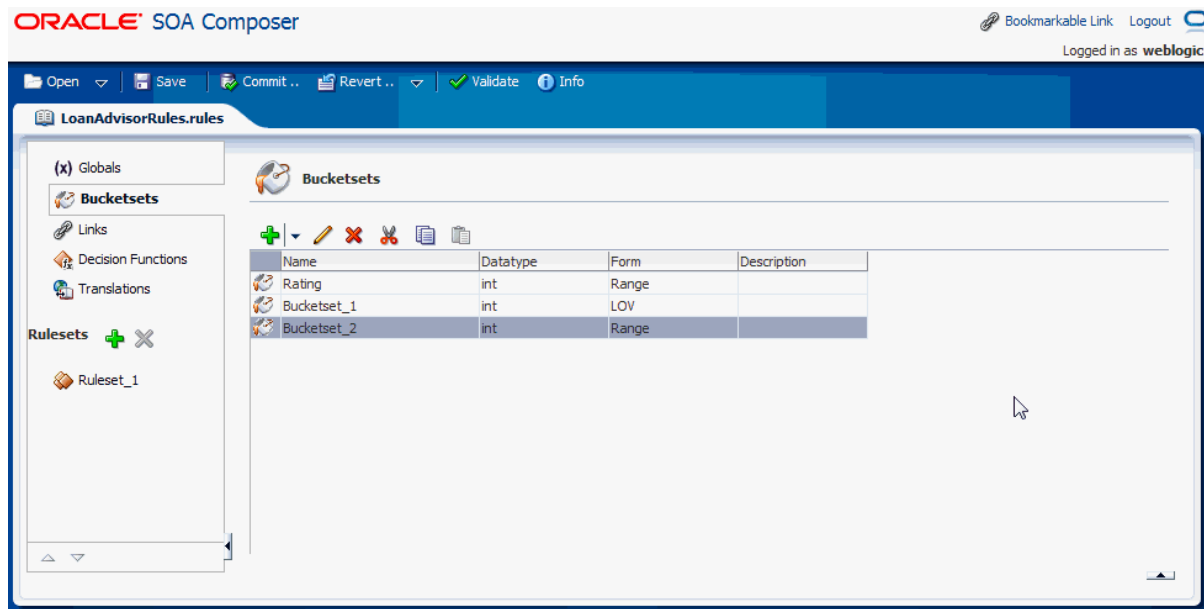


Figure 12–24 displays the Rating bucketset name after you have deselected the **Prefix Linked Names** checkbox in the **Links** tab. In this case, the linked dictionary name is not prefixed to the bucketset name.

**Figure 12–24 Prefixed Linked Dictionary Name Hidden**

For more information about linked dictionaries, see [Section 2.2.7, "What You Need to Know About Dictionary Linking."](#)

## 12.5.7 How to Edit Decision Functions in an Oracle Business Rules Dictionary at Runtime

In Oracle SOA Composer, in the edit mode, selecting the **Decision Functions** tab shows you a table listing the decision functions that are available to the dictionary, both parent and linked.

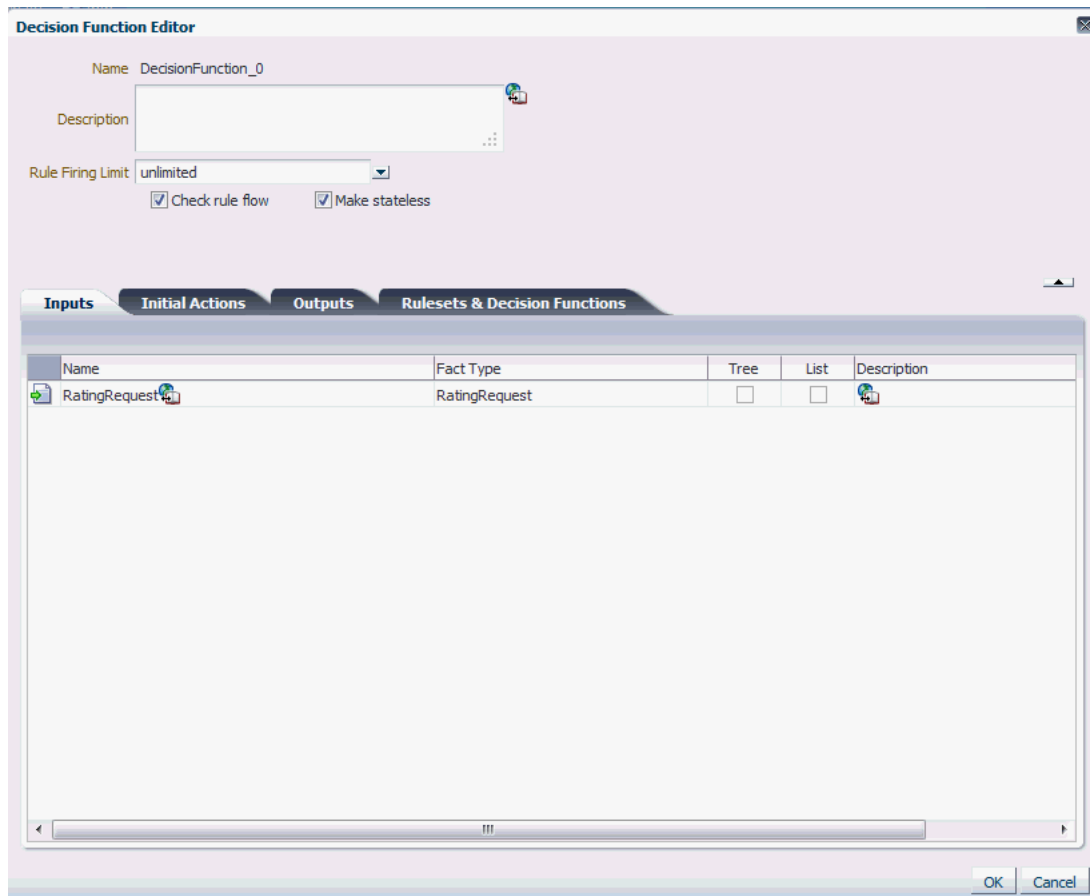
Currently, even in the edit mode, you can only modify the following fields and options:

- Description
- Rule Firing Limit
- Check rule flow
- Make stateless
- Initial Actions
- Rulesets and Decision Functions

### To edit a decision function:

1. To edit a decision function, in Oracle SOA Composer, select the **Decision Functions** tab. This displays a table listing the decision functions in the dictionary.
2. Select the appropriate decision function row and click the **Edit Decision Function** icon above the table. This displays the Decision Function Editor dialog box as shown in [Figure 12–25](#).

Figure 12–25 Decision Function Editor



3. In the **Description** field, optionally enter a description.
4. Enter the required number value from the **Rule Firing Limit** list. By default, the selected value is unlimited. However, you can enter an integer value for the rule firing limit and press the Tab key. The newly specified value gets added to the **Rule Firing Limit** list.
5. Select the appropriate decision function options:
  - **Check rule flow:** When selected, this option specifies that the rule flow is checked
  - **Make stateless:** When selected specifies the decision function is stateless.

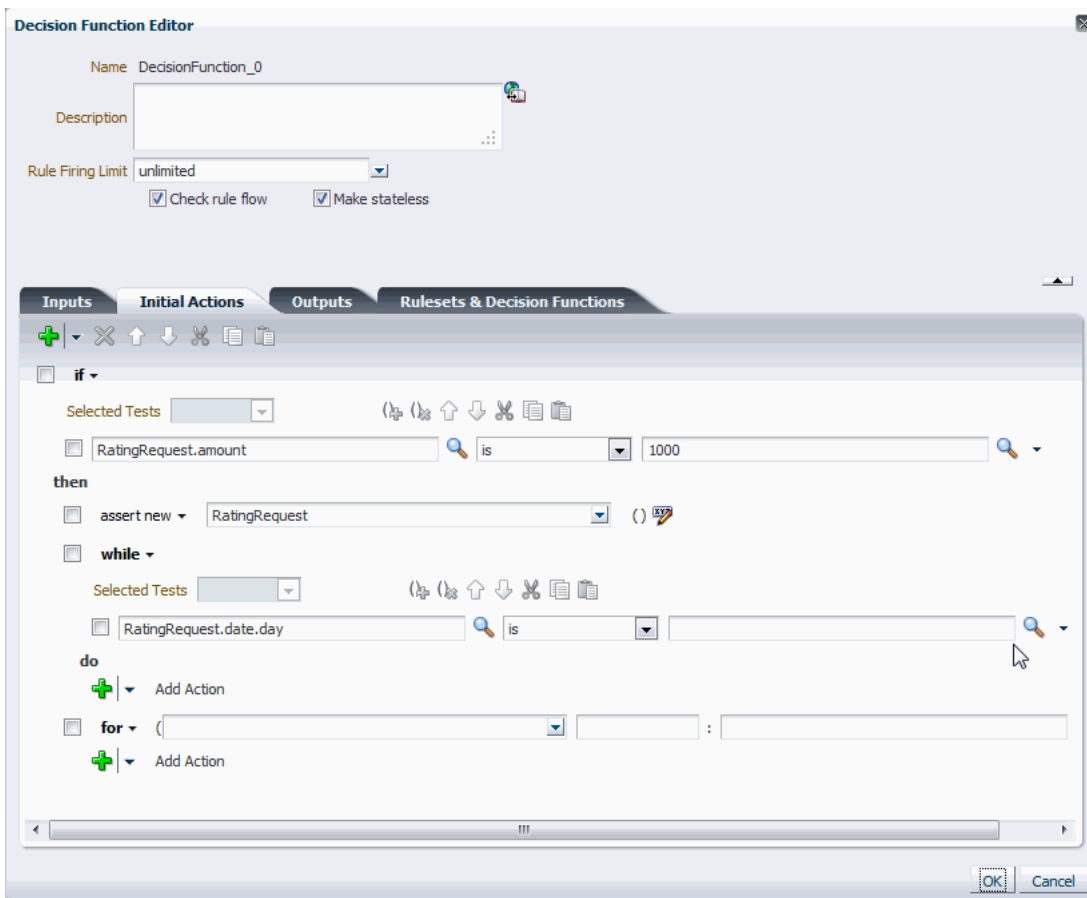
You cannot edit the following:

- Name field
  - Inputs tab
  - Outputs tab
6. In the **Initial Actions** tab, you can add actions that could be used to change input facts before they are asserted, change the ruleset stack, set the effective date, or even assert output facts. These actions could be used instead of rules, or to "set up" the environment for running rules. Initial Actions always run just before the inputs are asserted and the rules are run. The RL for the actions will be executed just before the inputs are asserted.

Consider a situation where a decision function (DF1) calls another decision function (DF2) using the **Initial Actions** tab. DF1 is configured to push Ruleset1 to the ruleset stack. DF2 is configured to push Ruleset2. In DF1, before the initial actions are executed, Ruleset1 is pushed to the ruleset stack. Then, when DF2 is called, Ruleset2 is also pushed. So when rules start running, rules from both rulesets fire because of the ruleset stack. If you want to push Ruleset2 (because in the initial actions, you are calling DF2), you can use initial actions in DF1 to clear the ruleset stack before calling DF2, and push Ruleset1 on the stack after calling DF2.

You can add any required action ranging from `assert`, `call`, `modify` to even conditional actions such as `if`, `else`, `elseif`, `while`, `for`, `if (advanced)`, and `while (advanced)` as shown in [Figure 12–26](#).

**Figure 12–26 Adding Initial Actions**



The `if (advanced)` and `while (advanced)` structs accept only boolean values. For each of the action conditions, you can add different test form types.

---

**Note:** If decision function DF1 contains DF2 in the **Rulesets & Decision Functions** tab, then DF2 may not have any initial actions.

---

7. In the **Rulesets & Decision Functions** tab, use the left and right arrow buttons to move items from the **Available** box to the **Selected** box.



8. Select an item in the **Selected** box, and click up or down arrow buttons as appropriate to order the rulesets and the decision functions.

For more information on decision functions, see [Chapter 6, "Working with Decision Functions."](#)

## 12.5.8 What You May Need to Know About Oracle Business Rules Dictionary Editor Declarative Component

You can use the Oracle Business Rules Dictionary Editor composite declarative component to leverage the functionality of editing Rules Dictionaries in any ADF-based Web application. It enables you to edit business rules metadata artifacts, such as Globals, Bucketsets, and Rulesets, by using the Rules SDK2 API.

For more information on Oracle Business Rules Dictionary Editor, see "Using the Oracle Business Rules Dictionary Editor Declarative Component" in *Developing SOA Applications with Oracle SOA Suite*.

## 12.5.9 What You May Need to Know About Oracle Business Rules Dictionary Editor Task Flow

Rules Dictionary Editor Task Flow, which is a wrapper around the Rules Dictionary Editor declarative component is used in ADF-based Web applications that require a task flow instead of a declarative component.

For more information on Oracle Business Rules Dictionary Editor, see "Using the Oracle Business Rules Dictionary Task Flow" in *Developing SOA Applications with Oracle SOA Suite*.

## 12.6 Editing Rules in an Oracle Business Rules Dictionary at Runtime

In Oracle SOA Composer with edit mode you can edit, add, and delete rules in a ruleset. For more information on how to use edit mode, see [Section 12.5, "Getting Started with Editing and Saving a Dictionary at Runtime"](#).

### 12.6.1 How to Edit Rules in an Oracle Business Rules Dictionary at Runtime

Oracle SOA Composer allows you to edit the rules in a dictionary.

#### To edit a rule with Oracle SOA Composer:

1. In Oracle SOA Composer, with an Oracle Business Rules dictionary open, select a ruleset.
2. Click the **Edit** menu item.
3. Oracle SOA Composer shows a confirm dialog if another user is currently editing the same dictionary. In the confirm dialog, click **No** or **Yes**, depending on whether you want to edit the document (if you click **Yes**, your changes could conflict with another user's changes). For more information, see [Section 12.10.1, "What You Need to Know About Editing With Multiple Users at Runtime"](#).
4. Oracle SOA Composer creates an area to save any modifications you make to the dictionary, and the **Edit** menu changes to a **Save** menu.

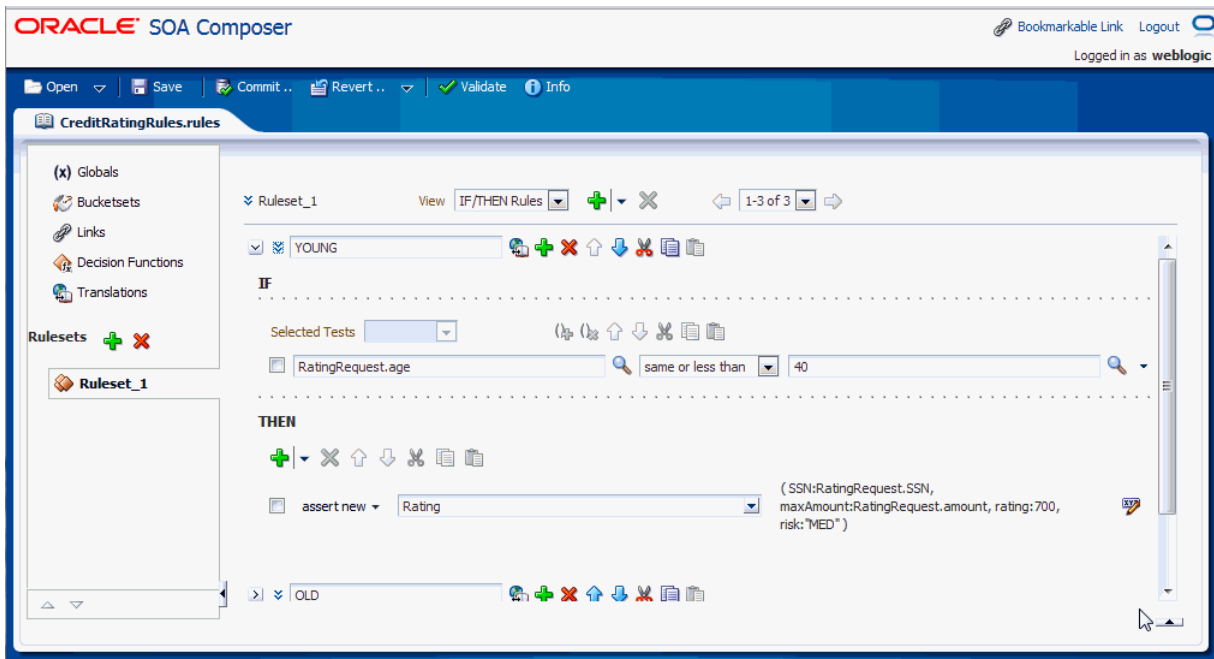
---

**Note:** The Edit view provides an interface to the dictionary that allows you to edit most dictionary components (you can only create and edit some dictionary components at design-time using the Rules Designer extension to Oracle JDeveloper).

---

- To edit an item in the dictionary, in the navigation tab, select the item of interest. For example, see [Figure 12–27](#) with the ruleset **SetupRules** selected.

**Figure 12–27 Using Oracle SOA Composer to Edit a Ruleset in a Dictionary**



- Click the **Save** menu item to save your changes in the work area.

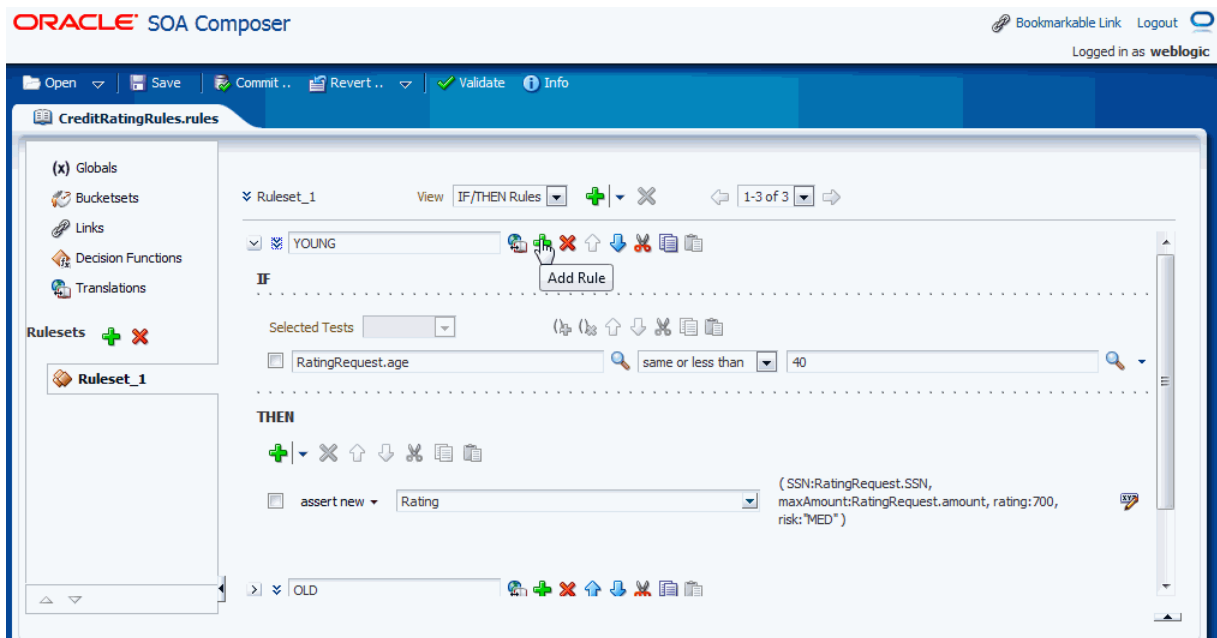
## 12.6.2 How to Add a Rule at Runtime

In Oracle SOA Composer you can add rules to a ruleset.

### To add a rule in a ruleset:

- In edit mode, select a ruleset of interest.
- In the rule area, click **Add Rule** as shown in [Figure 12–28](#). The rule is added immediately after the current one unlike Rules Designer, where a new rule is added at the end.

Figure 12–28 Adding a Rule in a Ruleset

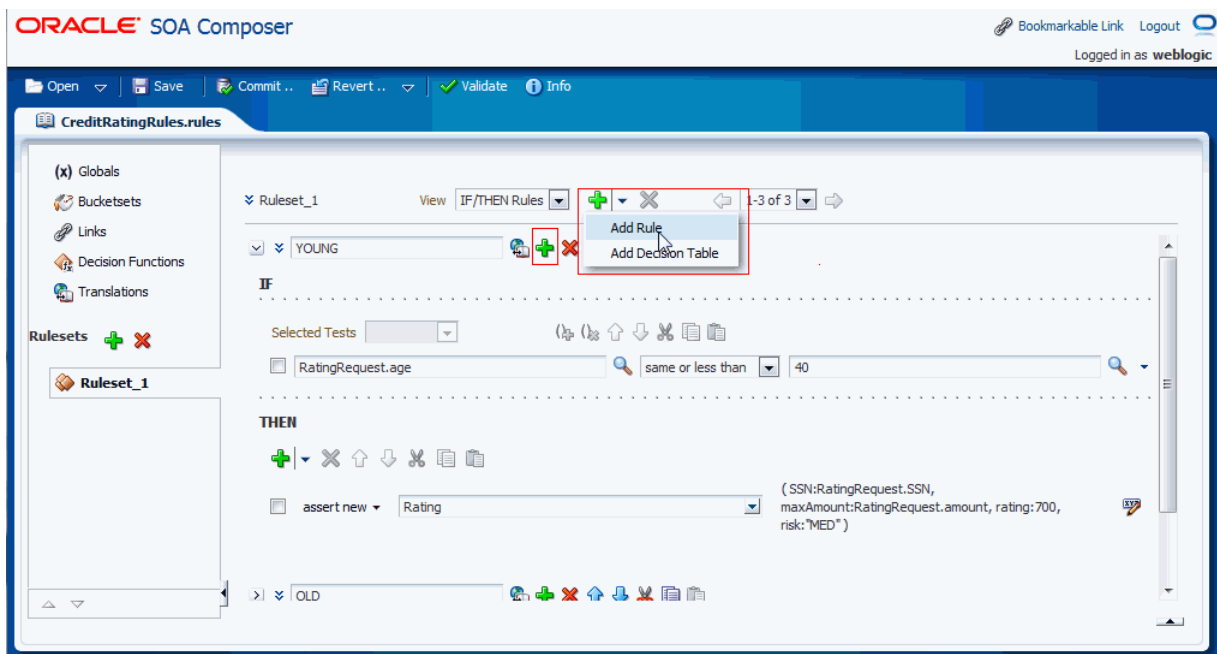


If the ruleset where you are adding a new rule does not contain any existing rule, then you can either:

- Click the down arrow adjacent to the **Add** icon and select **Add Rule** in the ruleset area
- Click the **Add Rule** icon in the rules area

Figure 12–29 displays the Add and the Add Rule icon.

Figure 12–29 Adding a New Rule



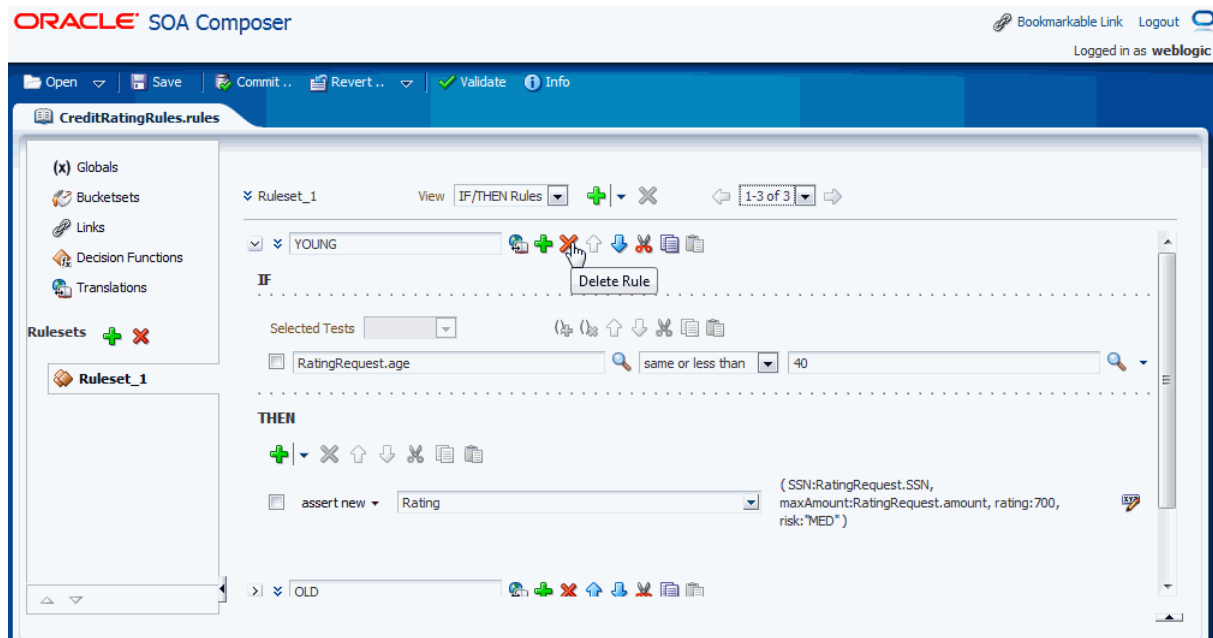
### 12.6.3 How to Delete a Rule at Runtime

In Oracle SOA Composer you can delete rules in a ruleset.

**To delete a rule in a ruleset:**

1. In edit mode, select a ruleset of interest.
2. In the rule area locate the rule you want to delete and click **Delete Rule**, as shown in [Figure 12–30](#).

**Figure 12–30** *Deleting a Rule in a Ruleset*

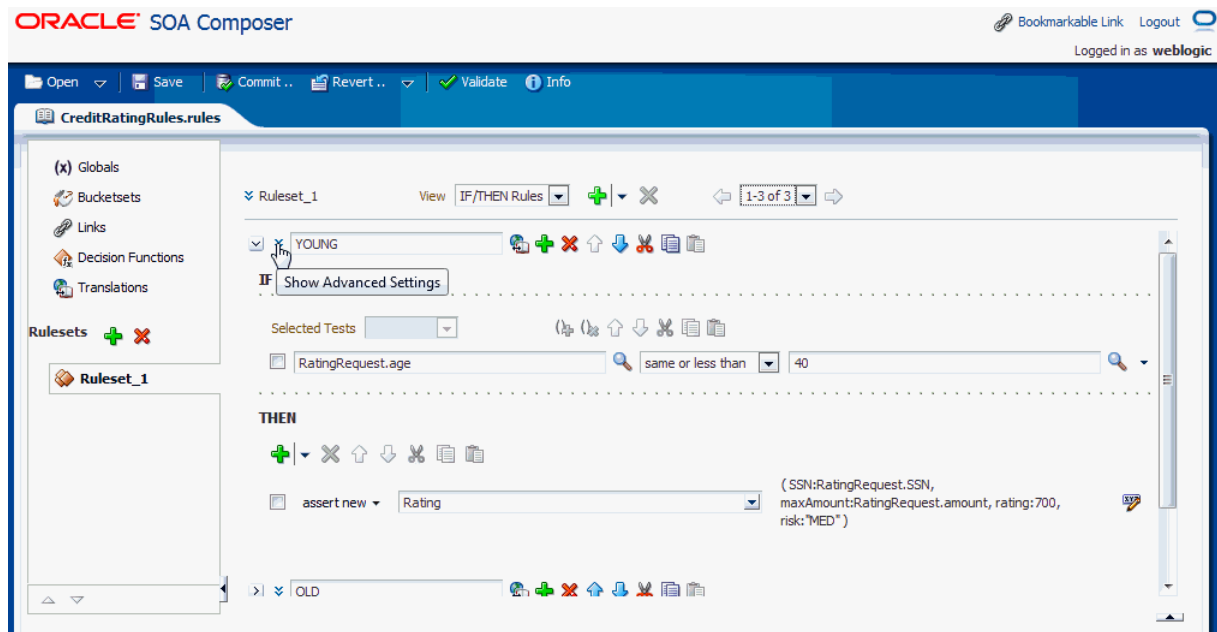


### 12.6.4 How to Show and Edit Advanced Settings for Rules at Runtime

In Oracle SOA Composer you can edit advanced settings for rules in a ruleset. For more information on advanced settings, see [Section 4.5, "Using Advanced Settings with Rules and Decision Tables"](#).

**To show and edit advanced settings in a rule:**

1. In edit mode, select a ruleset of interest.
2. In the rule area locate the rule you want to show or change advanced settings. Expand the rule first, if necessary.
3. Click the **Show Advanced Settings** icon next to the rule name. This displays the advanced settings, as shown in [Figure 12–31](#).

**Figure 12–31 Showing and Editing Rule Advanced Settings**

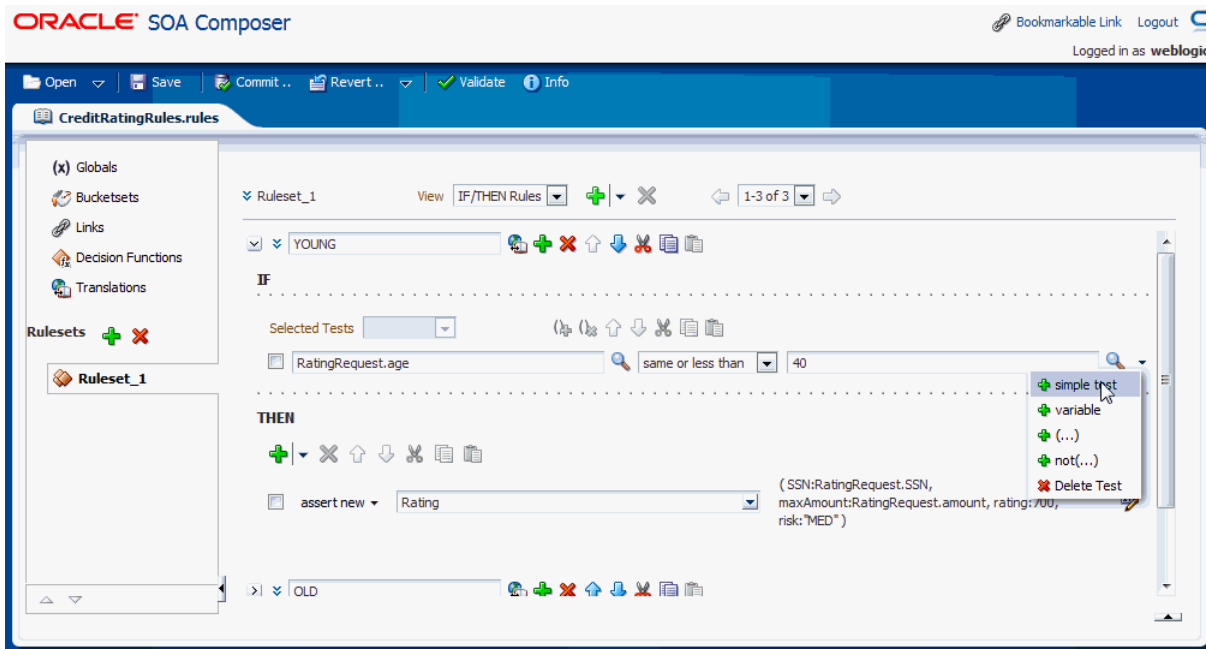
## 12.6.5 How to Add Rule Conditions at Runtime

In Oracle SOA Composer you can add conditions to a rule in a ruleset. For more information on working with rule conditions, see [Section 4.3, "Working with Rules"](#).

### To add rule conditions:

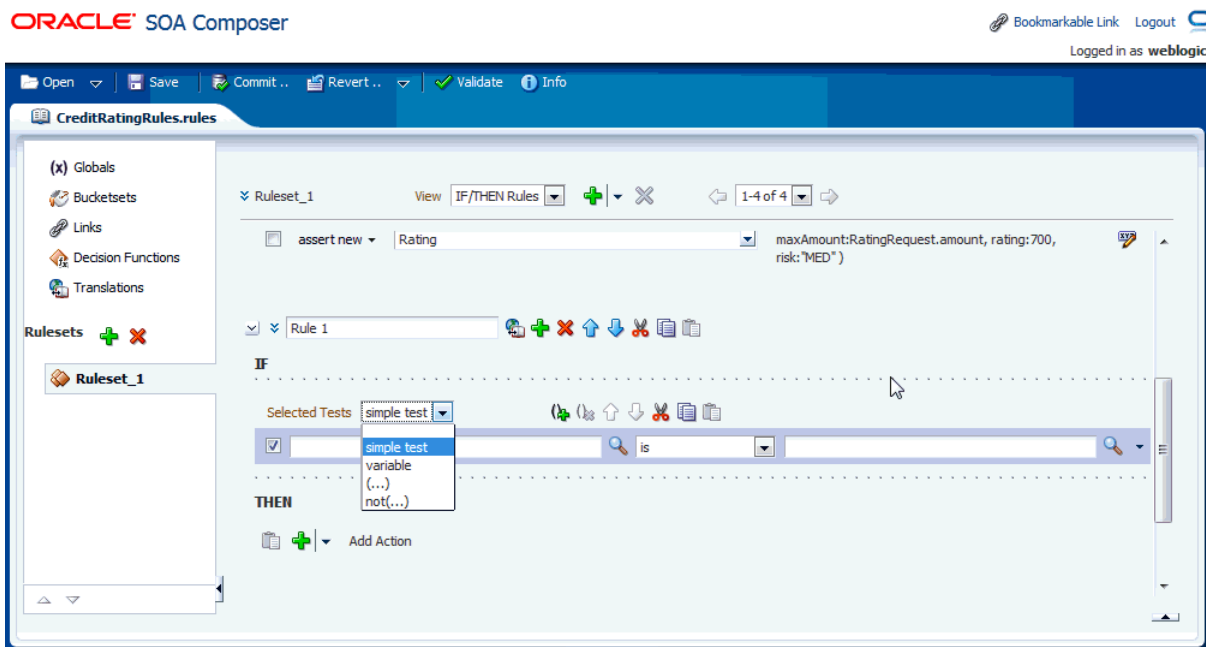
1. In edit mode, select a ruleset of interest.
2. In the rule area, locate the rule where you want to add a condition.
3. Next to the existing rule condition, click the down arrow to display a list of options available for adding a condition as shown in [Figure 12–32](#).

**Figure 12–32 Adding a New Rule Condition in a Ruleset**



If the rule where you want to add a condition does not contain any existing condition, then you need to click the Add Test down arrow to display a list of available options for adding a condition as shown in [Figure 12–33](#).

**Figure 12–33 Adding a Condition to a Blank Rule**



The following are the available options for adding a condition:

- simple test: Adds a simple test condition
- variable: Adds a variable definition. The variable and its value can be represented as an inline business term definition.

- (...): Adds a new simple test within a nested parenthesis
- not(...): Adds a new simple test within a NOT nested parenthesis

Each nesting level provides a list with the preceding options to operate on a nested block.

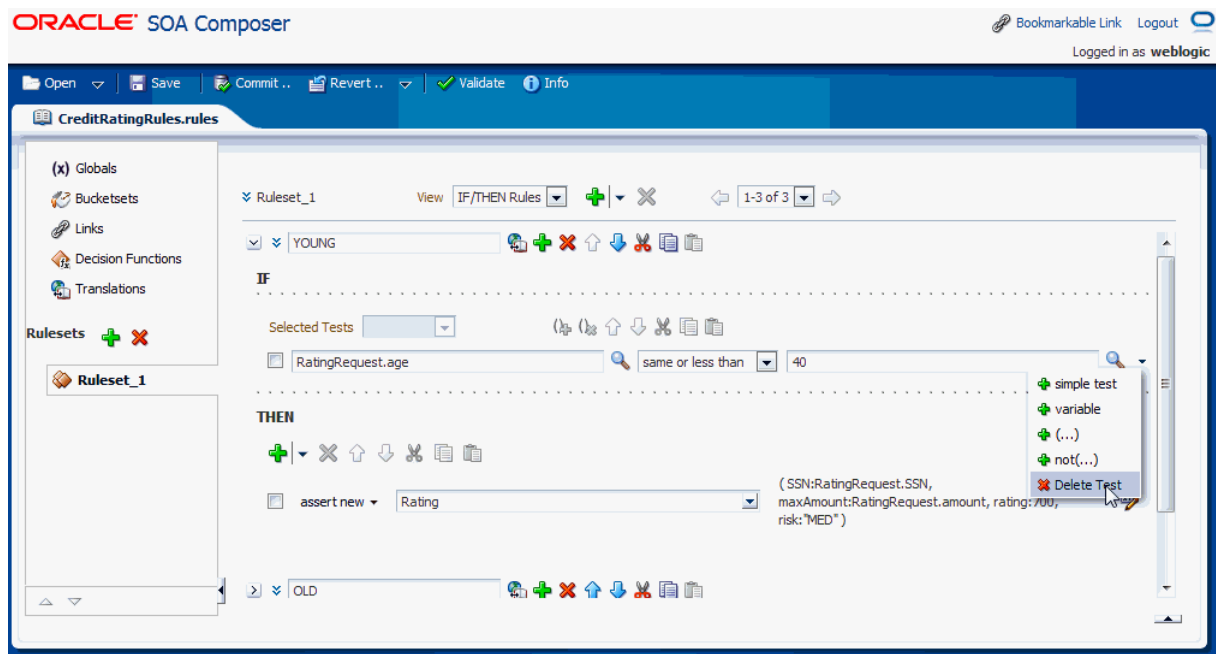
## 12.6.6 How to Delete Rule Conditions at Runtime

In Oracle SOA Composer you can delete conditions for a rule in a ruleset. For more information on working with rule conditions, see [Section 4.3, "Working with Rules"](#).

### To delete rule conditions:

1. In edit mode, select a ruleset of interest.
2. In the rule area, locate the rule where you want to delete a condition.
3. Next to the rule condition that you want to delete, click the down arrow, and then click **Delete Test** from the list as shown in [Figure 12–34](#).

**Figure 12–34** Deleting a Rule Condition in a Ruleset



Separate list is available for each nesting level. So the delete operation can be performed on a single condition or a nested block.

## 12.6.7 How to Modify Rule Conditions at Runtime

Using Oracle SOA Composer, you can edit conditions in a rule. You can select a rule condition for nesting or modify expression values within the condition. For more information on working with rule conditions, see [Section 4.3, "Working with Rules"](#).

### To modify a condition in a rule:

1. In edit mode, select a ruleset of interest.
2. In the rule area locate the rule where you want to modify conditions.

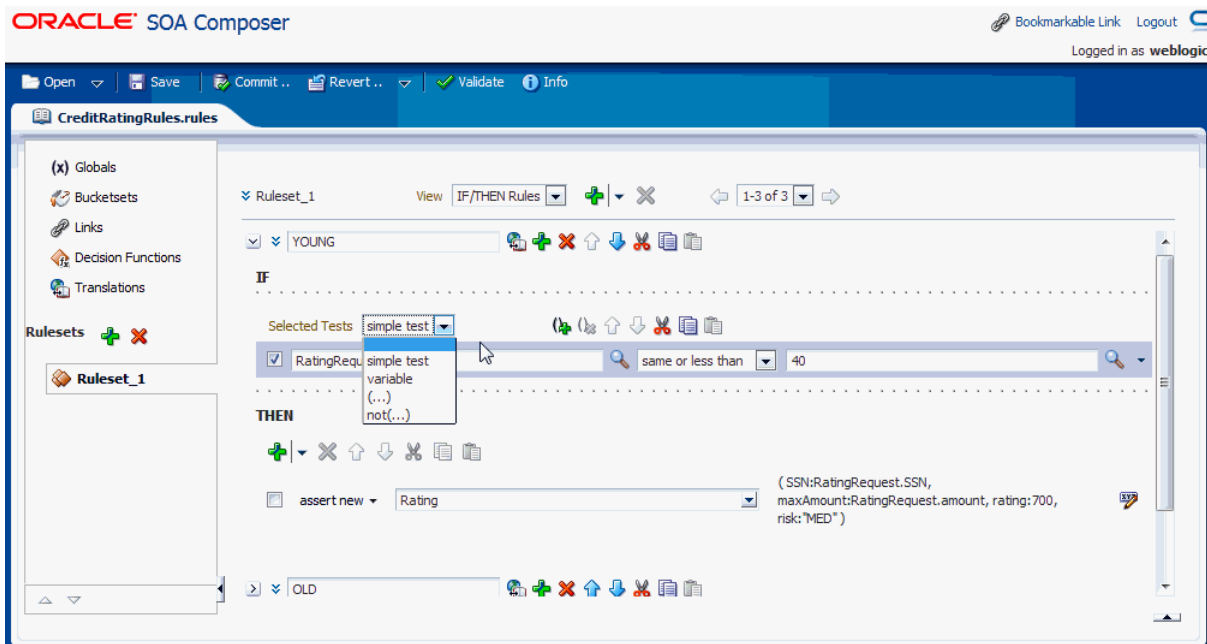
3. In the **IF** area, use the controls, icons, and selection boxes, including the **Left Value** expression icon, list for an operator, and **Right Value** expression icon to modify the condition.

Filtering is supported for expressions. For example, when you type `Employee`, values are filtered and the values with `Employee` are displayed in the drop-down. Use mouse or arrow keys to select a value.

You can use the [Expression Builder](#), [Condition Browser](#), [Date Browser](#), and [Right Operand Browser](#) to edit the left and right-side expressions.

In addition to modifying the values, you can also change the form type of a condition. For example, a simple test can be changed to variable definition and so on. To change the form type of a condition, you need to select the condition by using the adjacent check box and select the required form type from the **Selected Tests** list as shown in [Figure 12–35](#).

**Figure 12–35** Changing the Condition Type



## 12.6.8 How to Add Rule Actions at Runtime

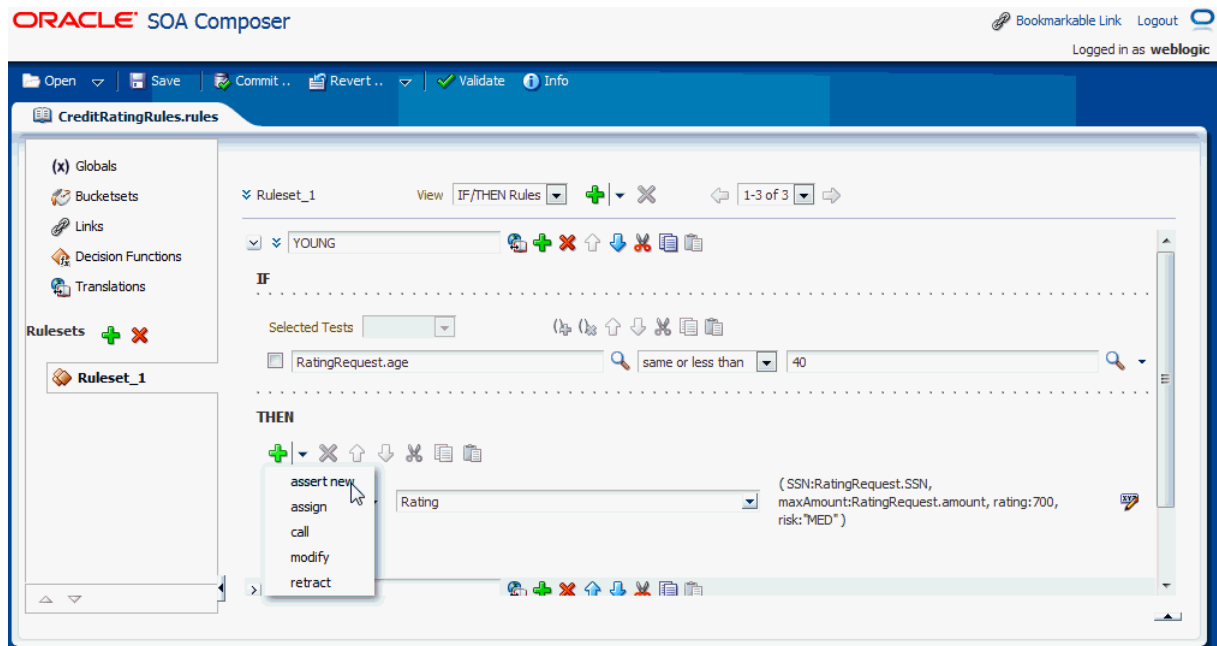
In Oracle SOA Composer you can add actions to a rule. For more information on working with rule actions, see [Section 4.3, "Working with Rules"](#).

### To add rule actions:

1. In edit mode, select a ruleset of interest.
2. In the rule area locate the rule where you want to add an action.
3. In the **THEN** area for the rule, next to the rule action click **Add Action**, as shown in [Figure 12–36](#).

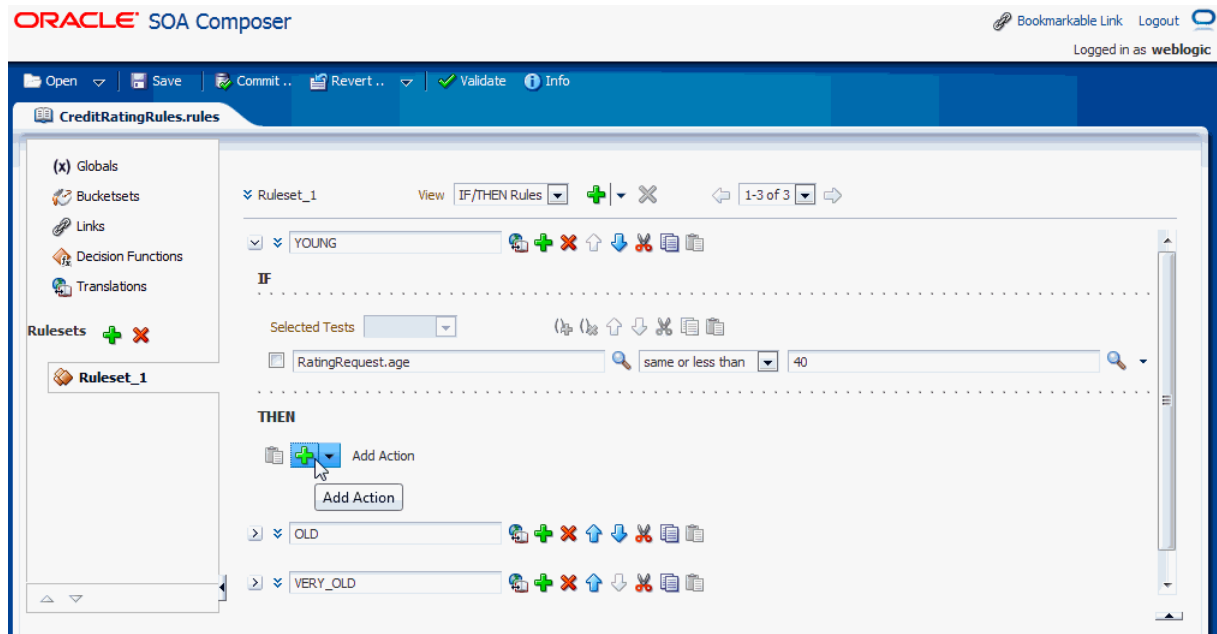


Figure 12–36 Adding a Rule Action in a Ruleset



If the rule to which you want to add an action does not contain any existing action, then you need to click the **Add Action** icon in the **THEN** area as shown in Figure 12–37.

Figure 12–37 Adding an Action



## 12.6.9 How to Delete Rule Actions at Runtime

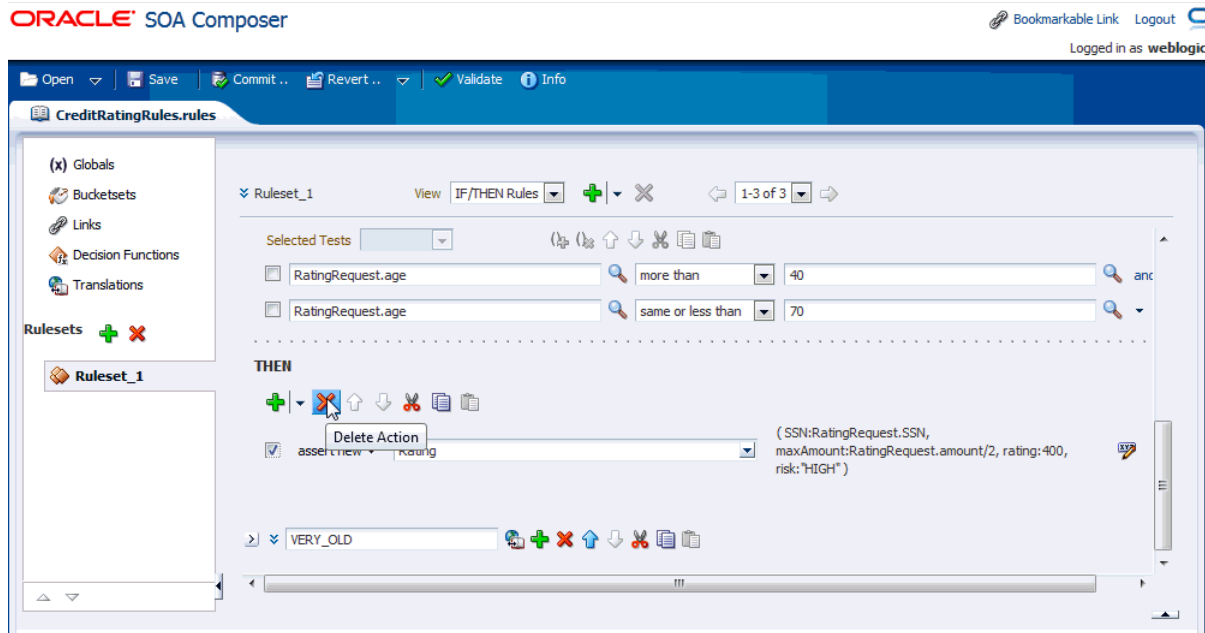
In Oracle SOA Composer you can delete actions in a rule. For more information on working with rule actions, see [Section 4.3, "Working with Rules"](#).

**To delete rule actions:**

1. In edit mode, select a ruleset of interest.
2. In the rule area, locate the rule where you want to delete an action.
3. In the THEN area for the rule, select the action.

Click **Delete Action**, as shown in [Figure 12–38](#).

**Figure 12–38 Deleting a Rule Action in a Ruleset**

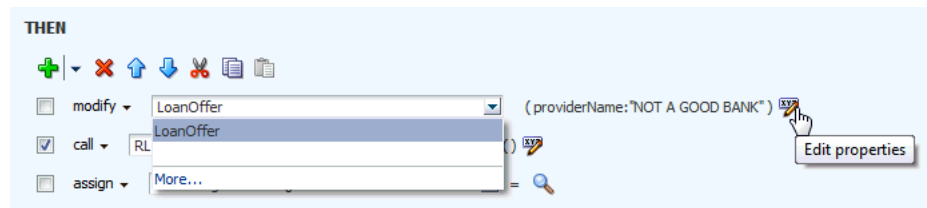


### 12.6.10 How to Modify Rule Actions at Runtime

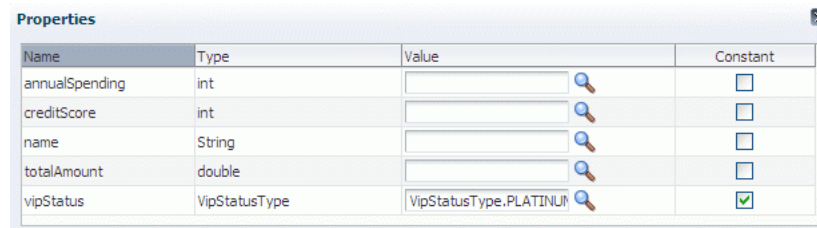
In Oracle SOA Composer you can modify actions in a rule. For more information on working with rule actions, see [Section 4.3, "Working with Rules"](#).

**To modify rule actions:**

1. In edit mode, select a ruleset of interest.
2. In the rule area, locate the rule where you want to modify an action.
3. In the THEN area for the rule as shown in [Figure 12–39](#) you can do the following:
  - Add and delete actions using Add and Delete icons on the top.
  - Select the action and move it up and down using the respective arrow icons.
  - Cut, copy and paste using the Cut, Copy and Paste icons on the top.
  - Click the **More** link in the drop-down area to launch **Select a Target** popup and select a value.
  - Click the **Edit Properties** icon next to the rule action and modify properties.

**Figure 12–39 The Edit Properties Icon**

The Properties dialog box is displayed where you can modify the property details as shown in [Figure 12–40](#).

**Figure 12–40 The Properties Dialog Box**

For more information on number formatting in rules, see [Section 12.5.1, "What You May Need to Know About Localized Number Formatting Support in Oracle SOA Composer."](#)

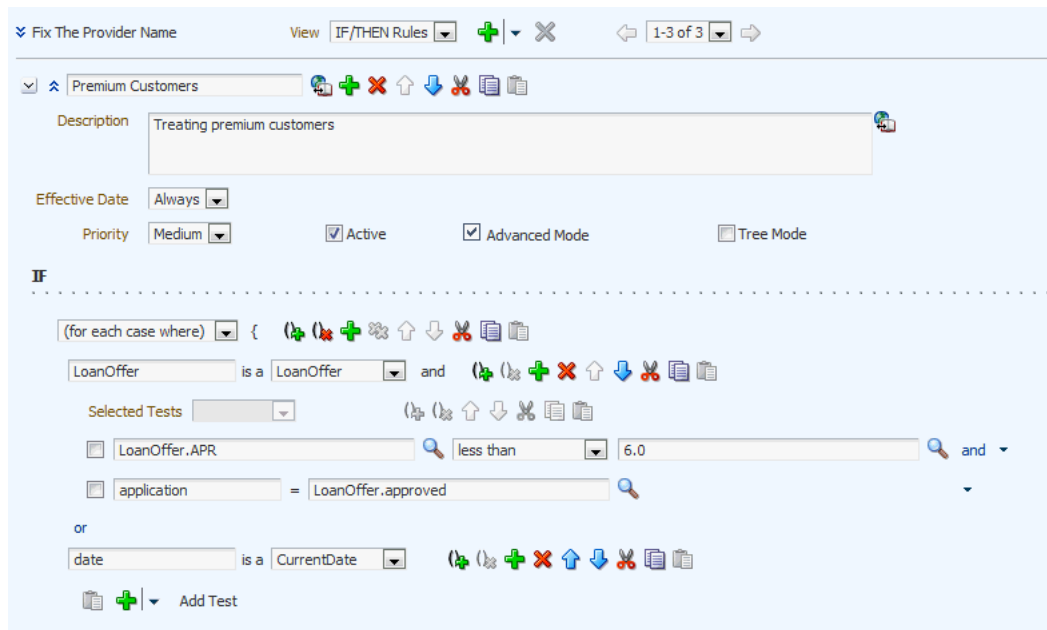
### 12.6.11 How to Work with Advanced Mode Rules at Runtime

In Oracle SOA Composer, you can work with advanced mode rules in a ruleset. For more information on working with advanced mode rules, see [Section 4.7, "Working with Advanced Mode Rules"](#).

#### To show and modify advanced mode rules:

1. In edit mode, select a ruleset of interest.
2. In the rule area, locate the rule where you want to show or modify advanced mode rules.
3. Click **Show Advanced Settings** icon to show advanced settings. For more information on showing advanced settings, see [Section 12.6.4, "How to Show and Edit Advanced Settings for Rules at Runtime"](#).
4. If the **Advanced Mode** icon is not selected, then select the **Advanced Mode** icon. This shows the advanced mode rule options, as shown in [Figure 12–41](#).

**Figure 12–41 Showing Advanced Mode Rule Options**



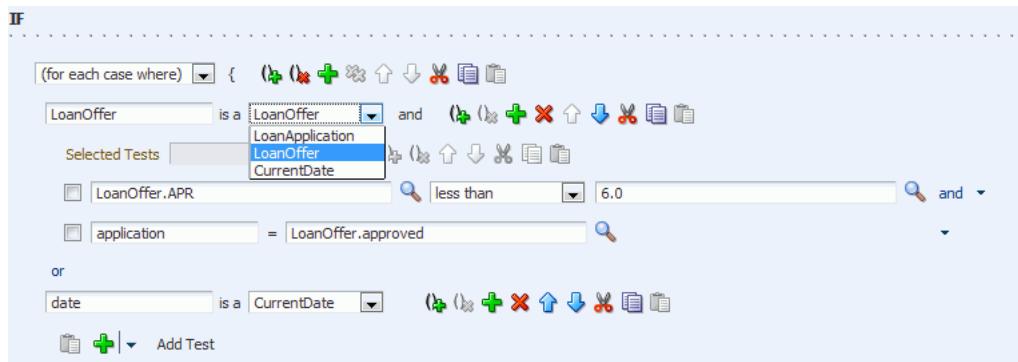
### 12.6.11.1 Working with Advanced Mode Options

The Advanced Mode rules options enables you to create, modify, and delete patterns, as well as add, modify, and delete conditions and actions within a pattern.

Using the Advanced Mode rule options, you can:

- Specify a pattern variable and select a fact type for the variable: You can directly enter the name of the pattern variable in the variable field. You can specify the fact type for the variable by using the fact type list as shown in [Figure 12–42](#).

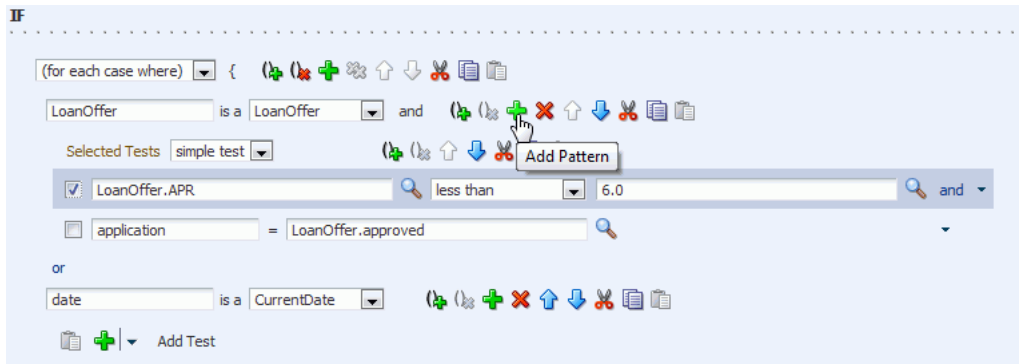
**Figure 12–42 Specifying Pattern Variable and Fact Type**



In the graphic example, CustomerOrder is a pattern variable of CustomerOrder fact type.

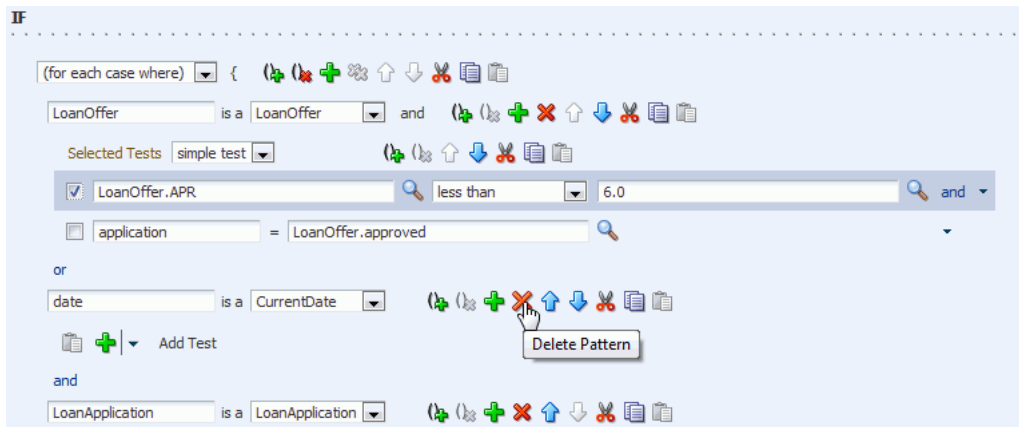
- Add a pattern: Click the **Add Pattern** icon to create a pattern to the existing rule. [Figure 12–43](#) displays an added pattern. The newly created pattern is blank.

**Figure 12–43 Adding a Pattern**



- Delete a pattern: Click the **Delete Pattern** icon to delete a pattern from a rule. [Figure 12–44](#) displays how to delete a pattern.

**Figure 12–44 Deleting a Pattern**



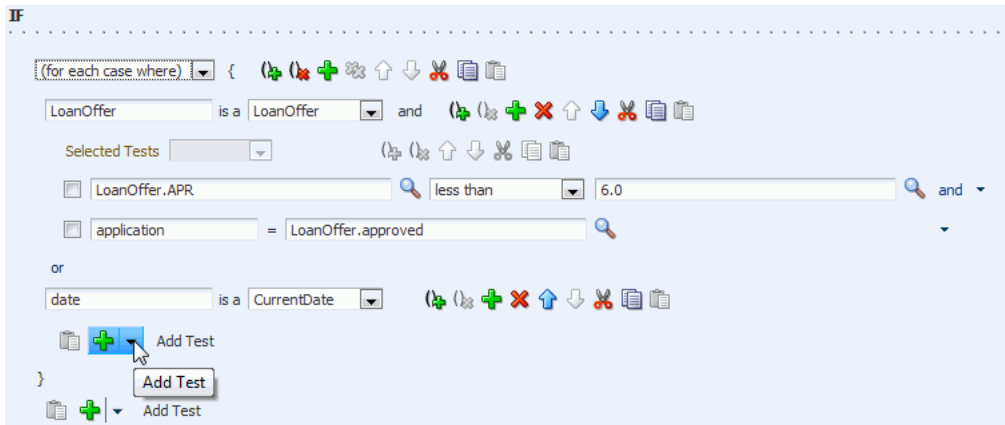
- Specify connectives: Two or more patterns are joined by a connective, and or or. You can use the connective link to toggle between the connectives.
- Work with nested patterns: A nested pattern has patterns inside it. These are enclosed within curly braces ({}). The pattern operator list is followed by the open curly brace. You can create a nested pattern by clicking **Surround pattern with parentheses** icon and you can remove the pattern nesting by clicking the **Remove parentheses from pattern** icon as shown in [Figure 12–45](#).

**Figure 12–45 Adding and Removing Pattern Nesting**



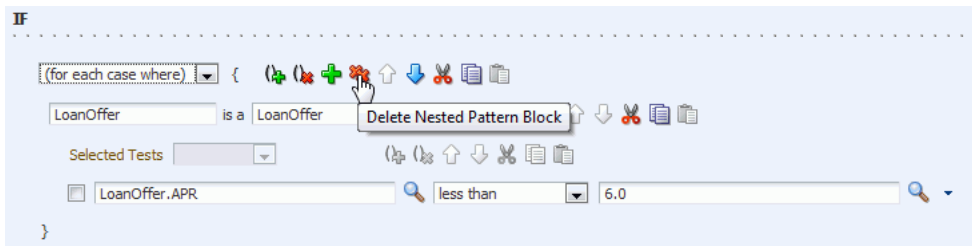
Inside the open curly brace, you can specify a pattern and then click the **Add Test** down arrow to add conditions to the nested pattern as shown in [Figure 12–46](#), as well as add another pattern to the same pattern block.

**Figure 12–46 Inserting Pattern Conditions**



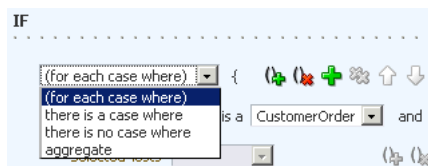
A nested pattern block ends with a closing curly brace. You can have multiple levels of nested patterns, which means that inside a nested pattern, you can have another nested pattern. You can click the **Delete Nested Pattern Block** icon to remove the entire nested pattern block as shown in [Figure 12–47](#).

**Figure 12–47 Deleting a Nested Pattern Block**



When you nest a pattern, an operator list is displayed with **(for each case where)** selected as the default operator in the operator list. The other items are **there is a case where**, **there is no case where**, and **aggregate** as shown in [Figure 12–48](#).

**Figure 12–48 Selecting the Pattern Operator**



The user interface remains the same as **(for each case where)** when you select **there is a case where** or **there is no case where** as the operator. However, when you select **aggregate**, the user interface changes. For an aggregate operator, you *must* enter a variable in the available field and select a function from the function list. The function list displays the following:

- count
- average
- maximum
- minimum

- sum
- collection

Except for the count function, all the other functions require an expression. You can specify an expression in the available field or launch the Condition Browser window.

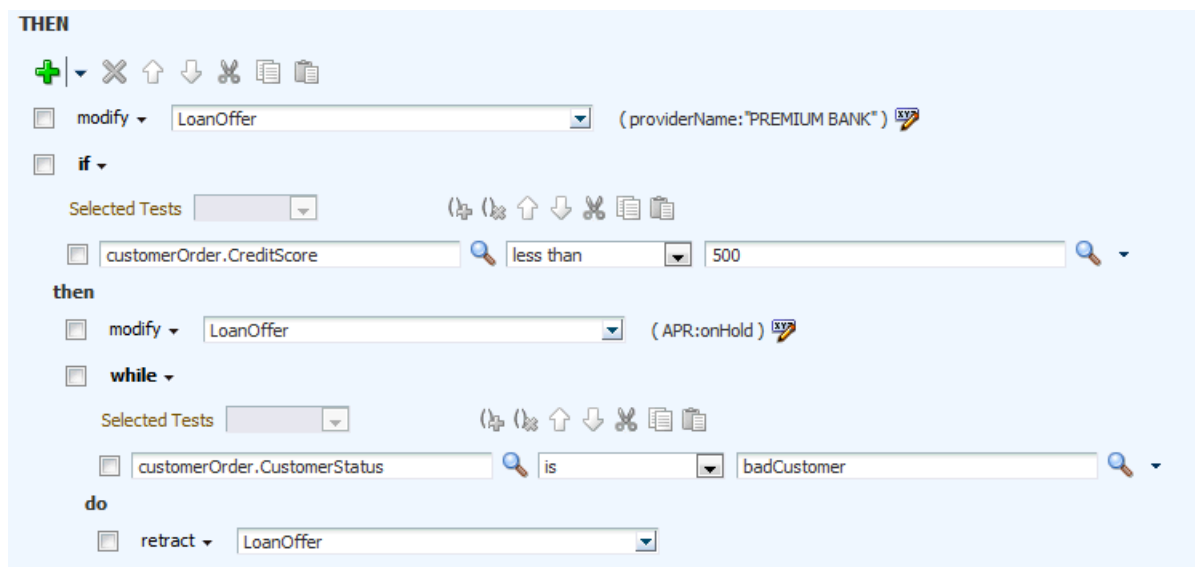
Figure 12–49 displays a nested pattern, where numPricey is the variable name and count is function name.

**Figure 12–49 The Count Aggregate Operator**



In the Advanced Mode of rules, in the THEN part, you can add any required action ranging from assert, call, modify to even conditional actions such as if, else, elseif, while, for, if (advanced), and while (advanced) as shown in Figure 12–50.

**Figure 12–50 Procedural Rules**



## 12.6.12 How to Work with Tree Mode Rules at Runtime

In Oracle SOA Composer you can work with tree mode rules in a ruleset. For more information on working with tree mode rules, see [Section 4.8, "Working with Tree Mode Rules"](#).

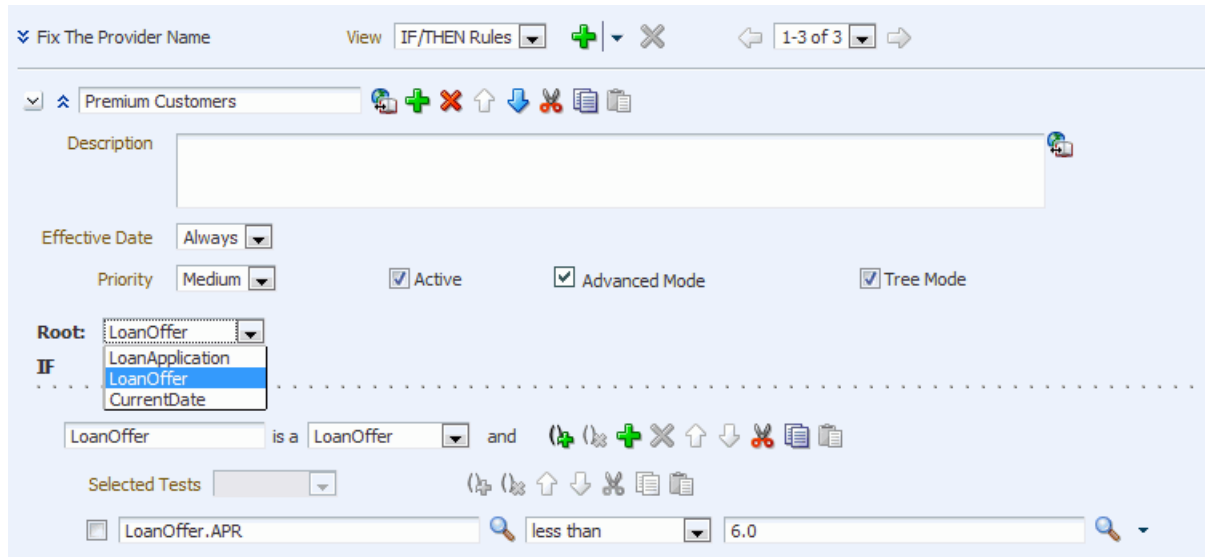
### To show and modify tree mode rules:

1. In edit mode, select a ruleset of interest.
2. In the rule area locate the rule where you want to show or modify tree mode rules.
3. Select **Advanced Settings** icon to show advanced settings. For more information on showing advanced settings, see [Section 12.6.4, "How to Show and Edit"](#)

[Advanced Settings for Rules at Runtime](#)".

4. If the **Tree Mode** icon is not selected, then select the **Tree Mode** icon. This shows the tree mode rule options, as shown in [Figure 12–51](#).

**Figure 12–51** Showing the Tree Mode Rule Area in a Rule



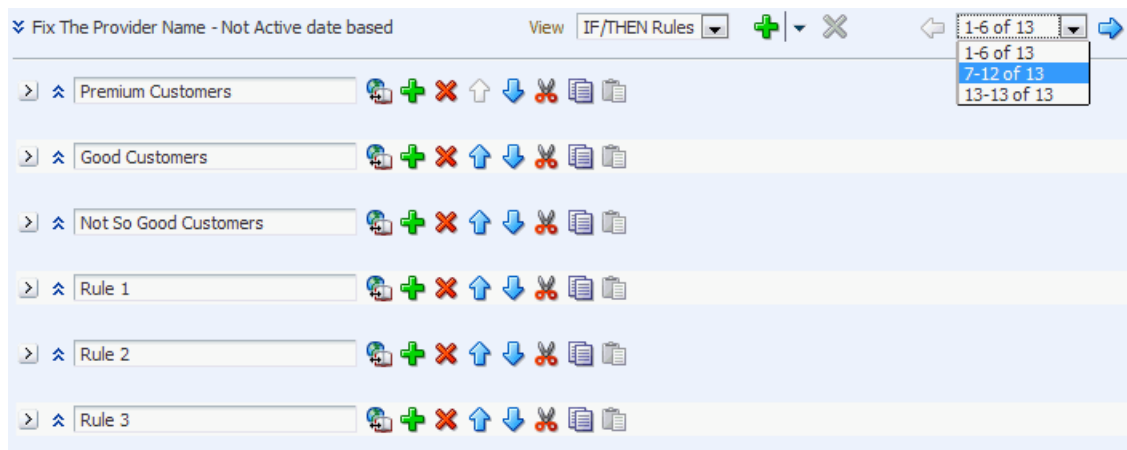
### 12.6.13 What You May Need to Know About Rules Paging in Oracle SOA Composer

In a ruleset with many rules, for the ease of navigation, the Oracle SOA Composer UI displays the rules in multiple pages, with each page containing a set of six rules. This paging capability ensures better performance when a ruleset with a large number of rules are loaded.

Oracle SOA Composer provides a list from where you can directly access the page where the rule of your choice exists. Alternatively, you can click the **Previous** and **Next** buttons on the either side of the list to move to the preceding or the following set of rules.

[Figure 12–52](#) displays the rules paging capability of Oracle SOA Composer.

**Figure 12–52** Rules Paging





## 12.6.14 What You May Need to Know About Oracle Business Rules Editor Declarative Component

You can use the Oracle Business Rules Editor composite declarative component to leverage the functionality of editing business rules in any ADF-based Web application. It enables you to edit business rules available in rulesets by using the Rules SDK2 API.

For more information on Oracle Business Rules Editor, see "Using the Oracle Business Rules Editor Declarative Component" in *Developing SOA Applications with Oracle SOA Suite*.

## 12.6.15 What You May Need to Know About Oracle Business Rules Dictionary Editor Declarative Component

The Oracle Business Rules Dictionary Editor is a composite declarative component that can be embedded in any ADF-based web application. It enables you to edit business rules metadata artifacts, such as globals, bucketsets, and rulesets, by using the Rules SDK2 API.

For more information on Oracle Business Rules Dictionary Editor, see Using the Oracle Business Rules Dictionary Editor Declarative Component in *Developing SOA Applications with Oracle SOA Suite*.

## 12.6.16 What You May Need to Know About Oracle Business Rules Dictionary Editor Task Flow

The Oracle Rules Dictionary Editor Task Flow is basically a wrapper around the Rules Dictionary Editor declarative component. The task flow is used in ADF-based web applications that require a task flow instead of a declarative component.

For more information on Oracle Business Rules Dictionary Editor Task Flow, see Using the Oracle Business Rules Dictionary Editor Task Flow in *Developing SOA Applications with Oracle SOA Suite*.

## 12.7 Using the Oracle SOA Composer Browser Windows

Oracle SOA Composer provides browser windows that helps you to work with different types of expressions such as rule expressions, XPATH expressions, date expressions, and so on.

The different types of browsers provided by Oracle SOA Composer are:

- [Expression Builder](#)
- [Condition Browser](#)
- [Date Browser](#)
- [Right Operand Browser](#)

### 12.7.1 Expression Builder

Expression Builder is used to build different types of expressions such as XPATH expressions, rule expressions, and so on.

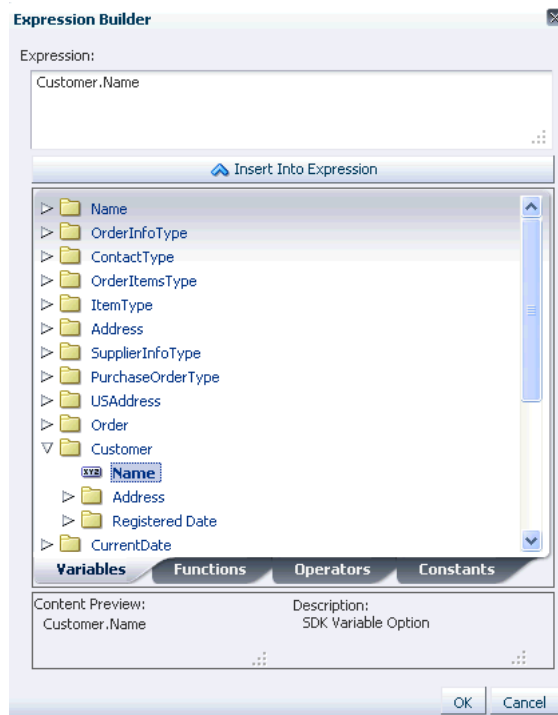
Expression Builder has a field where you can enter the expression directly. It has four tabs: Variables, Functions, Operators, and Constants. Each of these tabs display data in a tree structure. The Variables tab displays all the variables in the rules meta-data. The Functions tab displays all the functions in the rules meta-data. The Operators tab

displays operators such as +, -, \*, and so on. The Constants tab displays all the constants that exist in the rules meta-data.

You can switch between the tabs, select an item in the tree, and click the **Insert Into Expression** button to insert the selected item at the cursor position in the expression field. When an item is selected in the tree, the **Content Preview** and the **Description** areas display more information about the selected item. Once you create the expression and click **OK**, the newly created expression appears in the field that is available to the left of the expression builder icon.

Figure 12–53 displays the Expression Builder browser.

**Figure 12–53 The Expression Builder Browser**



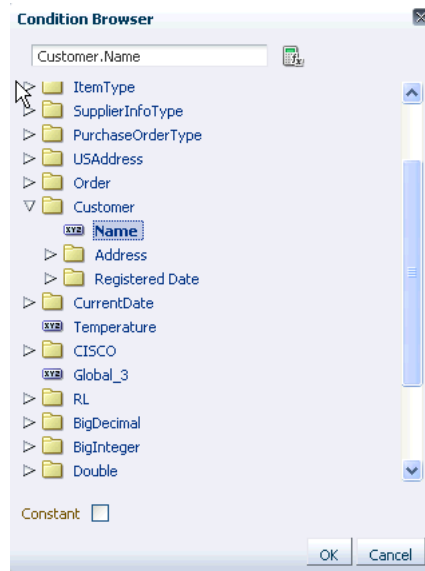
## 12.7.2 Condition Browser

The Condition Browser has a field, a hierarchical tree, and an Expression Builder embedded inside it. You can enter the expression directly in the field, or select an item from the tree. Condition Browser supports filtering. For example, when you start entering `customer` the tree is narrowed down to items with `customer`.

When an item is selected in the tree, the new selection appears in the field immediately. You can also use the embedded Expression Builder to create an expression.

Once the Expression Builder is launched and an expression is created, the new expression appears in the Condition Browser field. Once you create an expression and click the **OK** button in the Condition Browser, the newly created expression appears in the field that is to the left of the Condition Browser icon.

Figure 12–54 displays the Condition Browser.

**Figure 12–54 The Condition Browser**

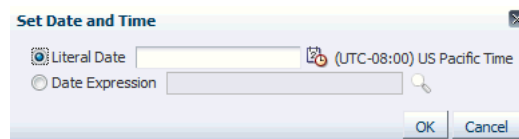
### 12.7.3 Date Browser

The Date Browser is used to select a Literal Date or a Date Expression. The Date Browser has two options to switch between a Literal Date and a Date Expression. When one option is selected, the other one is disabled.

Select:

- Literal Date option to enter a date using a Calendar pop-up
- Date Expression option to enter the expression directly in the Date Expression field or to launch the Condition Browser to select a date expression.

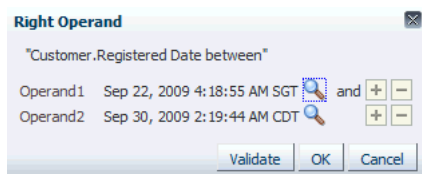
Figure 12–55 displays the Date Browser.

**Figure 12–55 The Date Browser**

### 12.7.4 Right Operand Browser

The Right Operand browser is used to select multiple right expressions. The browser displays operands in each row. You can enter an expression directly in the operand field or launch the Condition Browser to select an expression. The + icon adds a row after the current one. The - icon deletes the current row. These icons are enabled and disabled based on the selected operator. For instance the in operator allows multiple right expressions. So in this case, the icons are enabled.

Figure 12–56 displays a Right Operand browser.

**Figure 12–56 The Right Operand Browser**

---

---

**Note:** Using Right Operand browsers, you can enter multiple values for the right-side expression. However, you can place a Date browser outside a Right Operand browser, and in which case, only one expression can be entered. For both these browsers, you cannot enter values directly in the right-side expression field. Once you have entered values using the browser and clicked OK, the values get added as comma-separated values on the Rules UI.

---

---

## 12.8 Editing Decision Tables in an Oracle Business Rules Dictionary at Runtime

When Oracle SOA Composer is in edit mode, you can edit, add, and delete a Decision Table in a ruleset. For more information on how to use edit mode, see [Section 12.5, "Getting Started with Editing and Saving a Dictionary at Runtime"](#).

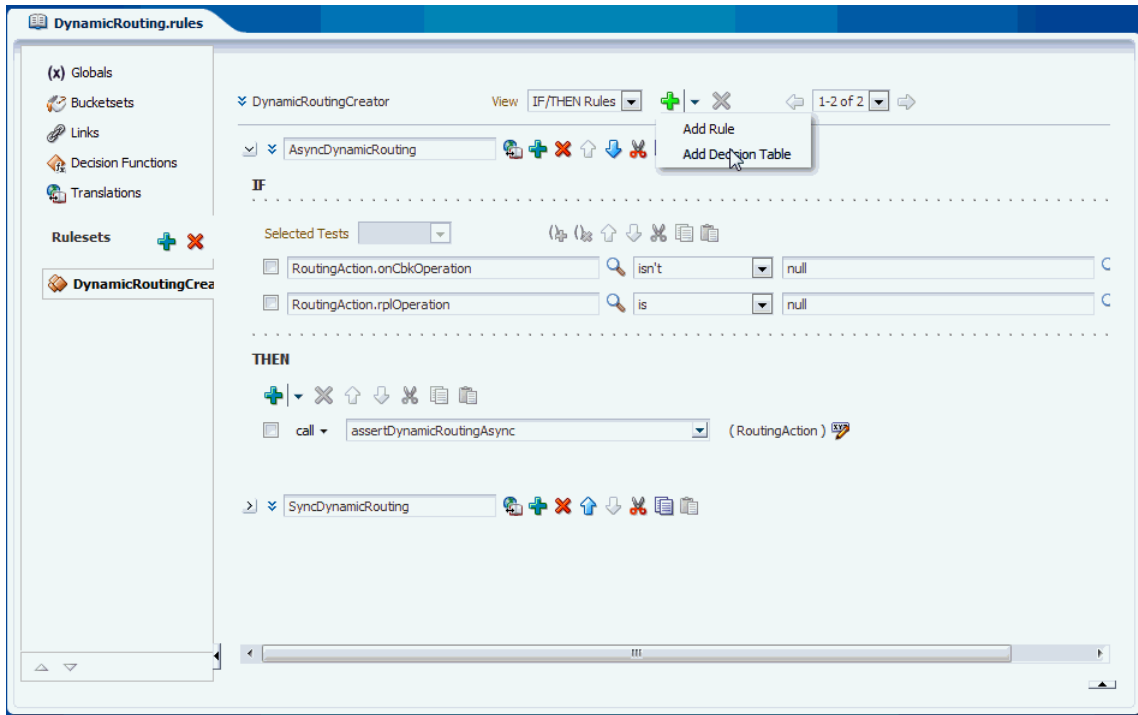
### 12.8.1 Adding a Decision Table at Runtime

In Oracle SOA Composer, you can add a Decision Table to a ruleset. For more information on working with Decision Tables, see [Section 5.1, "Introduction to Working with Decision Tables"](#).

**To add a Decision Table in a ruleset:**

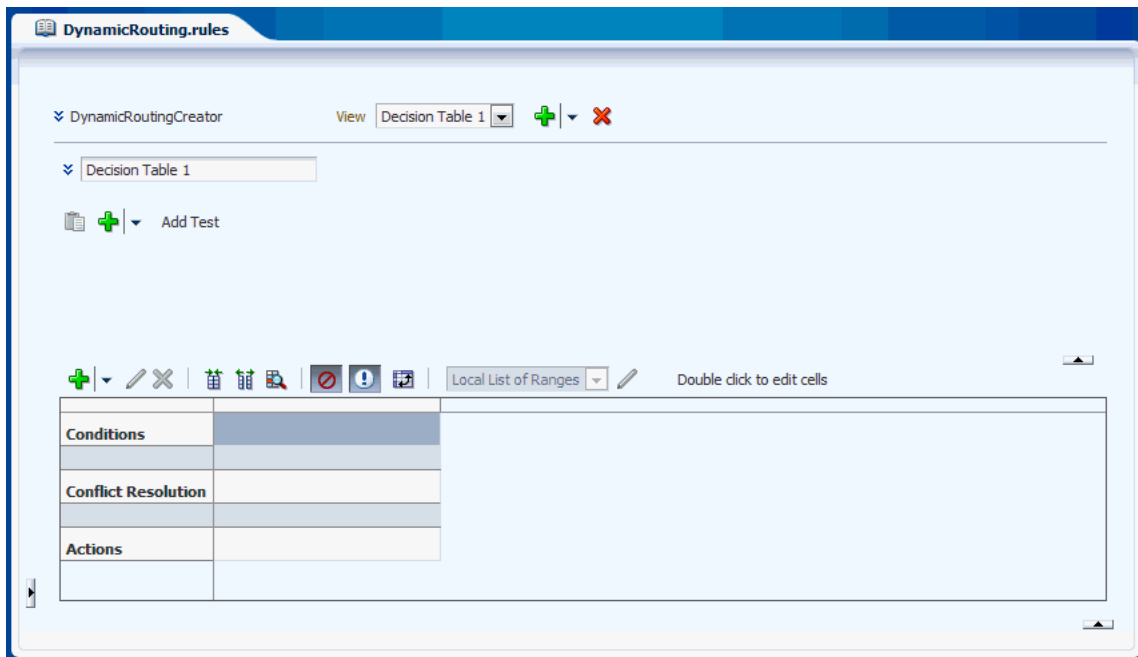
1. In edit mode, select a ruleset of interest.
2. In the ruleset area, click **Add** and then **Add Decision Table**, as shown in [Figure 12–57](#).

**Figure 12–57 Adding a Decision Table in a Ruleset**



A blank Decision Table is displayed as shown in [Figure 12–58](#).

**Figure 12–58 A Blank Decision Table**



## 12.8.2 Adding Condition Rows to a Decision Table

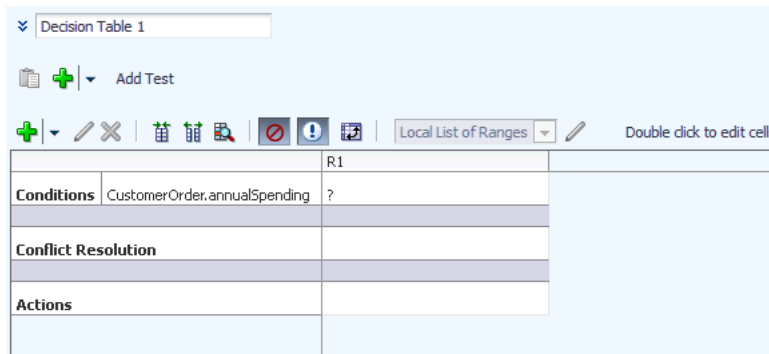
Using Oracle SOA Composer, you can add condition rows to a Decision Table.

**To add condition rows to a Decision Table:**

1. From Oracle SOA Composer, select a ruleset from the **Rulesets** navigation tab and select the Decision Table where you want to add conditions from the **View** box (for example, Decision Table 1).
2. In the Decision Table toolbar, from the list next to the **Add** icon, select **Add Condition** that displays the Condition Browser window where you can specify or select conditions.

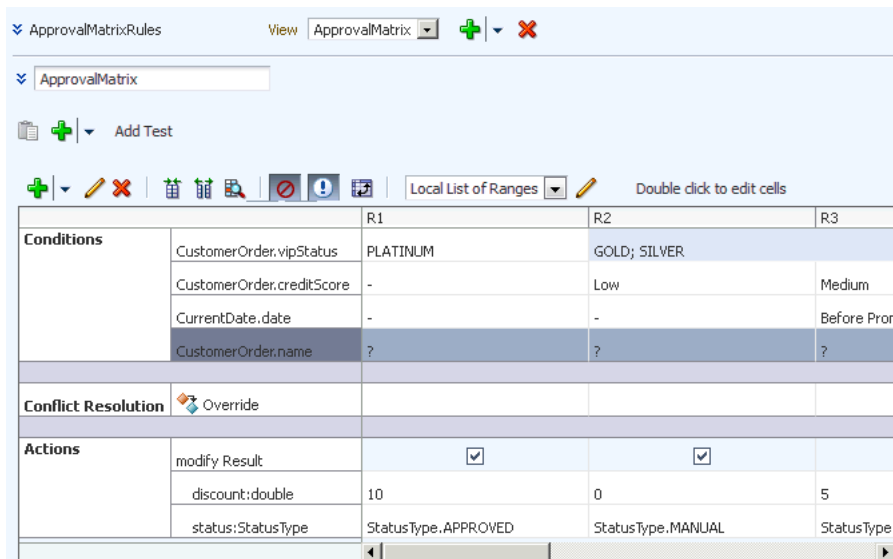
The selected or specified condition row and a Rules column with the header R1 is added to the table; the cell below R1 has a "?" symbol (Figure 12-59). The "?" symbol indicates that the cell does not have a value yet.

**Figure 12-59 New Condition Row Added in a New Decision Table**



If you are adding a condition to a table that has existing condition rows, similar to adding a condition to a blank Decision Table, Oracle SOA Composer prompts for specifying the condition details. Once the details are provided, the specified condition is added as the last condition row; the condition cells under each rule column in the new row also have "?" symbols, as shown in Figure 12-60.

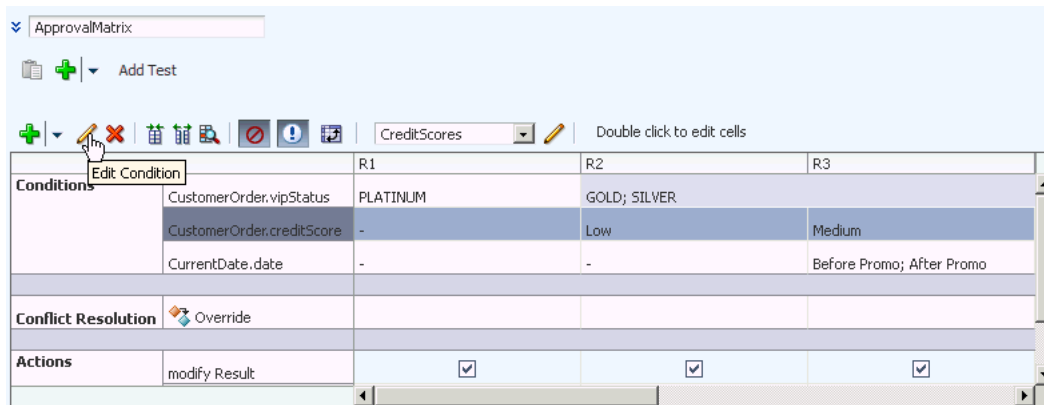
**Figure 12-60 New Condition Row Added As Last Row in a Decision Table**



For information about all symbols that might be used in a decision table, see [Section 12.8.4.1, "Editing Decision Table Cells."](#)

3. If you want to edit a specified condition, in the **Conditions** area, click the condition row, and then click the **Edit Condition** icon on the toolbar as shown in [Figure 12–61](#). This displays the Condition Browser.

**Figure 12–61** *Editing a Condition to a Decision Table*



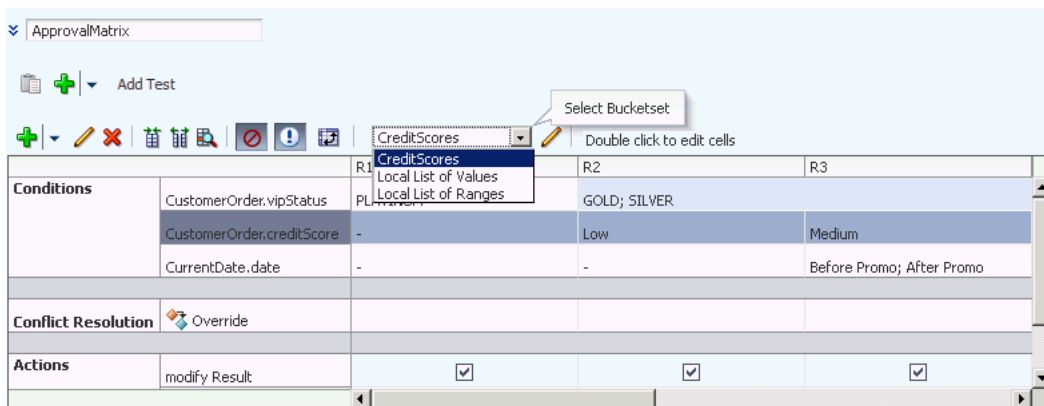
4. Enter an expression by clicking in the Conditions Browser to select a variable, or click the **Expression Builder** icon to display the Expression Builder.  
Expression Builder lets you build expressions.
5. Each condition row requires a bucketset from which to draw the values for each cell. When the value you select has an associated global bucketset, then by default the bucketset is associated with the condition row.

If there is no global bucketset associated with the value, then after you add a condition row to a Decision Table, you need to either specify an existing global bucketset or create a Local List of Values or a Local List of Ranges bucketset.

To associate a bucketset for the condition, perform either of the following:

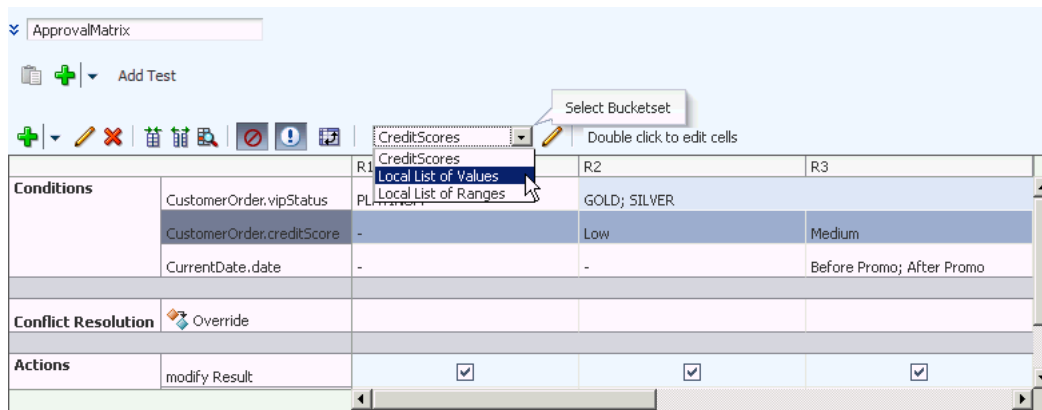
- In the **Conditions** area, select the condition, and select an existing bucketset from the **Select Bucketset** list as shown in [Figure 12–62](#).

**Figure 12–62** *Associating an Existing Bucketset With a Condition Row*



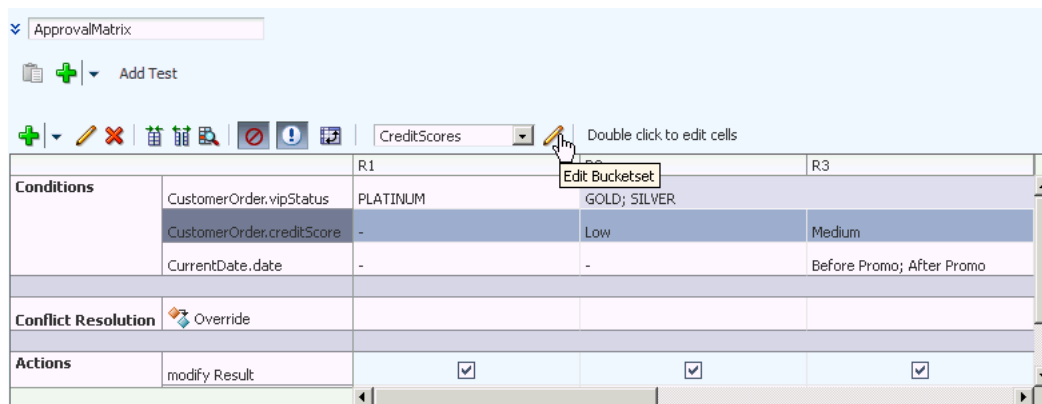
- In the **Conditions** area, select the condition, and select either **Local List of Values** or **Local List of Ranges** (as relevant) from the **Select Bucketset** list as shown in [Figure 12–63](#).

**Figure 12–63 Associating a Local List of Values or Local List of Ranges With a Condition Row**



You can edit the bucketset for the selected condition by clicking the **Edit Bucketset** icon as shown in Figure 12–64.

**Figure 12–64 Editing a Bucketset**



This displays the Bucketset Editor where you can add, edit or delete buckets. If editing a Local List of Values bucketset, you can also reorder buckets in the bucketset.

For more information on number formatting in bucketsets, see [Section 12.5.1, "What You May Need to Know About Localized Number Formatting Support in Oracle SOA Composer."](#)

- Repeat **Step 2** through **Step 5**, as required to add additional condition rows in the Decision Table.

For more information on adding condition rows, see [Section 5.2.2, "How to Add Condition Rows to a Decision Table"](#).

### 12.8.3 Adding Actions to a Decision Table

In Oracle SOA Composer, you can add actions to a Decision Table.

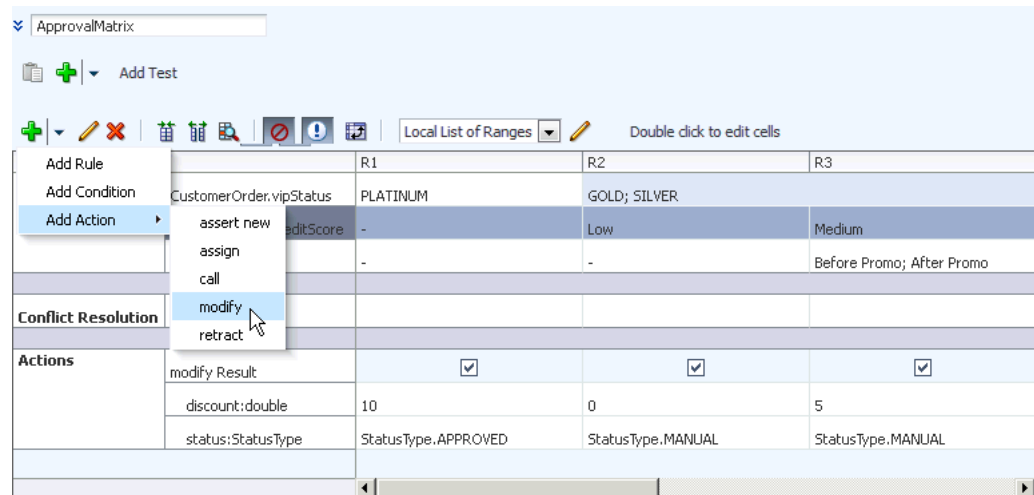
**To add actions to Decision Table:**

- From Oracle SOA Composer, select a ruleset from the **Rulesets** navigation tab and select the Decision Table where you want to add actions.



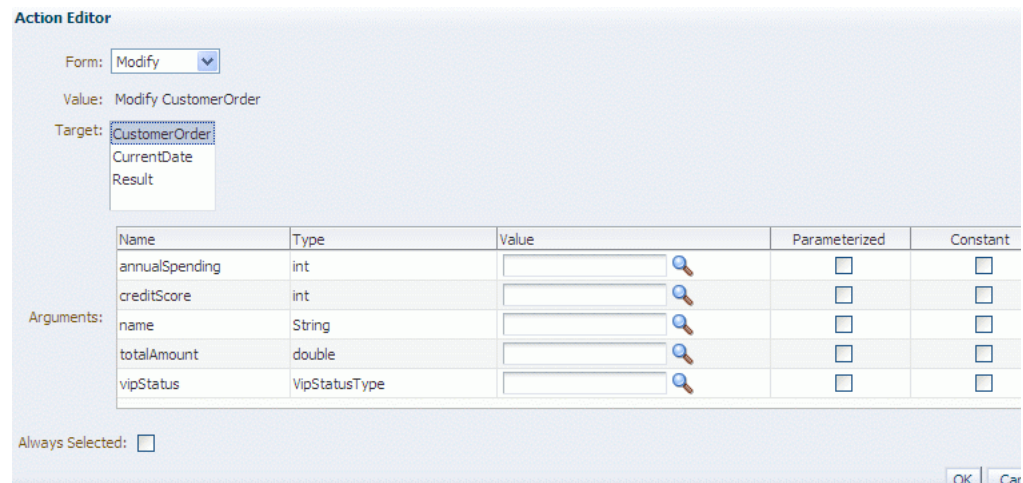
- From the list next to the **Add** icon, select **Add Action** and select an available action from the list. For example, click **Modify** as shown in [Figure 12–65](#).

**Figure 12–65 Adding an Action to a Decision Table**



The Action Editor window is displayed as shown in [Figure 12–66](#).

**Figure 12–66 The Action Editor Window**



[Table 5–1](#) in [Chapter 5, "Working with Decision Tables,"](#) lists the available actions.

- In the Action Editor window, select the action target and then specify values for an action cell.

For more information on number formatting in bucketsets, see [Section 12.5.1, "What You May Need to Know About Localized Number Formatting Support in Oracle SOA Composer."](#)

For more information on adding actions to Decision Tables, see [Section 5.2.3, "How to Add Actions to a Decision Table."](#)

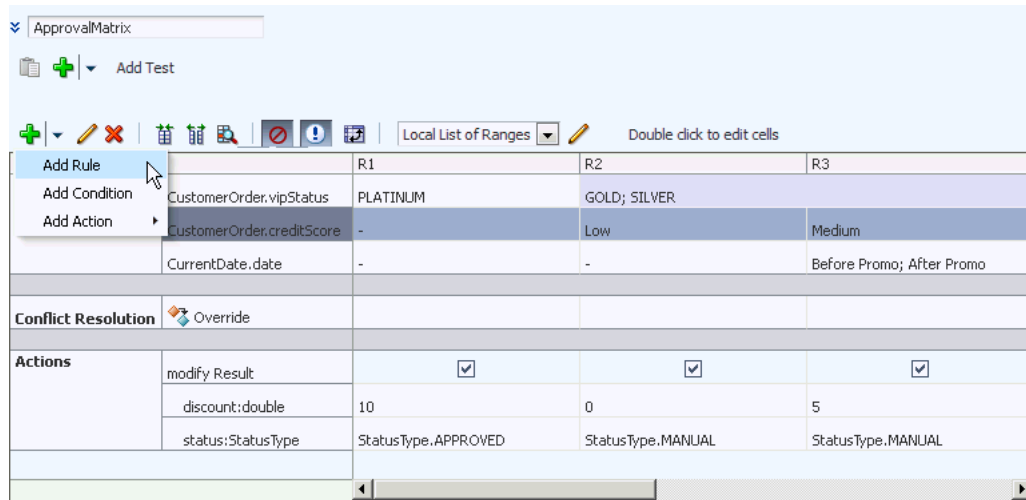
## 12.8.4 Adding Rules to a Decision Table

Using Oracle SOA Composer, you can add a rule to a Decision Table.

**To add a rule to a Decision Table:**

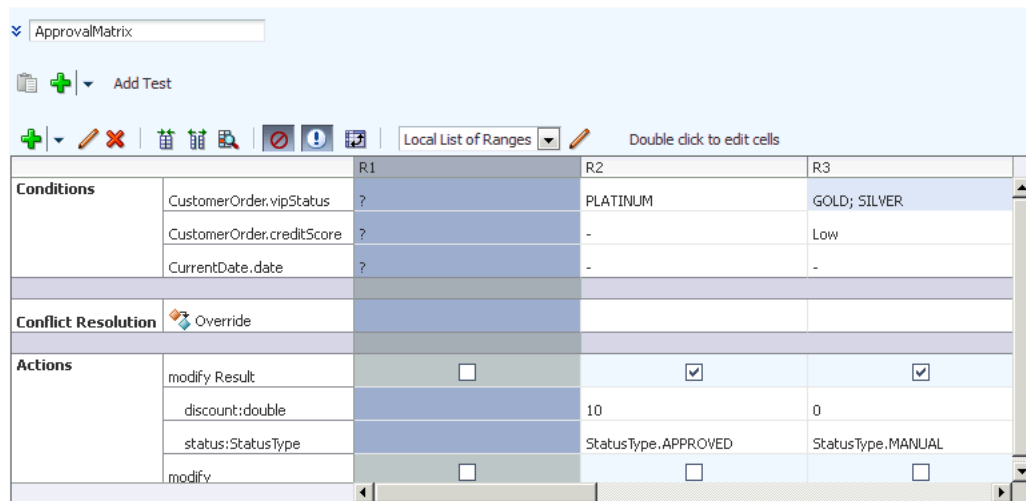
1. From Oracle SOA Composer, select a ruleset from the **Rulesets** navigation tab and select the Decision Table where you want to add the rule.
2. From the list next to the **Add** icon, select **Add Rule** as shown in [Figure 12-67](#).

**Figure 12-67 Adding a Rule to a Decision Table**



A new column for the added rule is displayed as shown in [Figure 12-68](#).

**Figure 12-68 Added Rule in the Decision Table**



**Note:** When you add a rule to a blank Decision Table, Oracle SOA Composer displays the Condition Browser window, and after you select or specify a condition, a condition row gets added automatically.

Notice that the new rule is added as the first rule of the Decision Table and the other rules have moved as required to keep the bucket values in their defined order. This is because **Order Rules By Bucket** is enabled by default, which means rule ordering in a Decision Table is set according to the relative position of buckets

associated with a condition expression. If **Order Rules By Bucket** is not enabled when you add a rule, the new rule is added as the last rule of the Decision Table. In either case, the cells in the new rule column have "?" symbols, indicating the cells do not have values yet.

For information about all symbols used in a table, see [Section 12.8.4.1, "Editing Decision Table Cells."](#) For additional information about rules ordering, see [Section 12.8.4.2, "Controlling the Order of Rules in a Decision Table."](#)

3. Enter values for the condition cells by double-clicking the cells.

---

**Note:** You can enter values for the condition cells (or any other cells) only by double-clicking the cell.

---

4. Double-click an Action row to enter values for the action cells.

---

**Note:** If because of the inadequate column width, you cannot view the complete contents of a cell in a Decision Table, you can roll your mouse pointer over the cell to view the contents.

---

### 12.8.4.1 Editing Decision Table Cells

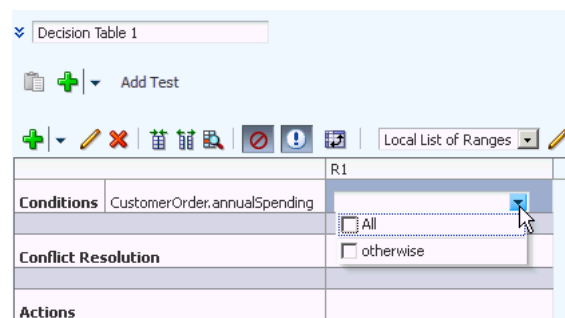
Each rule in a Decision Table contains cells pertaining to three sections: Conditions, Conflicts, and Actions.

#### Working with Condition Cells

In view mode, a condition cell with a "?" symbol indicates that the cell does not have a condition value. If a cell has two or more values specified, a semicolon-separated list of values is displayed in the cell.

In the editable mode (that is, when you double-click a conditions cell), the condition cells display specified condition values in multichoice lists. When editing a new rule or when a condition value is unspecified, the condition cell is blank, as shown in [Figure 12-69](#).

**Figure 12-69 Unspecified Condition Value**



If you select **All**:

- When the particular condition cell is double-click, the cell displays "All"
- When the particular condition cell is not selected, the cell displays the "-" symbol

Figure 12–70 shows a Decision Table with a condition cell displaying the value "All" in editable mode, a cell displaying the "-" symbol, and cells displaying a semicolon-separated list of values.

**Figure 12–70** *Displaying All Values for a Condition*

		R1	R2	R3
<b>Conditions</b>	CustomerOrder.vipStatus	PLATINUM	GOLD; SILVER	
	CustomerOrder.creditScore	All	Low	Medium
	CurrentDate.date	-	-	Before Promo; After Promo
<b>Conflict Resolution</b>		Override		
<b>Actions</b>	modify Result	<input checked="" type="checkbox"/>	<input checked="" type="checkbox"/>	<input checked="" type="checkbox"/>
	discount:double	10	0	5
	status:StatusType	StatusType.APPROVED	StatusType.MANUAL	StatusType.MANUAL
	modify	<input type="checkbox"/>	<input type="checkbox"/>	<input type="checkbox"/>

You can select any value that is available in the condition value list.

---

**Note:** When you edit the condition cells, if **Order Rules By Bucket** is selected, the Decision Table is refreshed and the edited rule column may shift to the left or right depending on the selected condition cell value.

---



---

**Note:** You can modify the bucketset associated with a condition, by clicking the condition. This enables the bucketset list and the **Edit Bucketset** icon so that you can edit the associated bucketset.

---

### Working with Action Cells

When you add an action, an action row is created with the specified action type. There are two types of action cells:

- The Action form cells contain checkboxes. When a rule fires, only selected actions are executed. In Figure 12–71, R1 and R3 action checkboxes are selected whereas the other action checkboxes are deselected. In this case, if R1 fires, the action will be executed, but if R2 fires, then the action will not be executed.

---

**Note:** The **Edit Action** icon is enabled only if the action form cell row is selected. The **Edit Action** icon invokes the Action Editor window.

---

- The Action parameter cells contain the parameters of the action form. You can directly enter the action parameter values in the respective field or you can invoke the Condition Browser window to select a value.

Figure 12–71 displays both types of action cells. You can see that the action parameter cells, in edit mode, have edit fields with the Condition Browser icons next to them.

**Figure 12–71 The Action Cells in a Decision Table**

The screenshot shows a decision table editor for 'ApprovalMatrix'. It includes a toolbar with icons for adding tests, editing, and deleting. The table is organized into three main sections: Conditions, Conflict Resolution, and Actions.

		R1	R2	R3
<b>Conditions</b>	CustomerOrder.vipStatus	PLATINUM	GOLD; SILVER	
	CustomerOrder.creditScore	-	Low	Medium
	CurrentDate.date	-	-	Before Promo; After Promo
<b>Conflict Resolution</b>		Override		
<b>Actions</b>	modify Result	<input checked="" type="checkbox"/>	<input checked="" type="checkbox"/>	<input checked="" type="checkbox"/>
	discount:double	10	0	5
	status:StatusType	StatusType.APPROVED	StatusType.MANUAL	StatusType.MANUAL
	modify	<input type="checkbox"/>	<input type="checkbox"/>	<input type="checkbox"/>

Figure 12–72 displays the Action Editor window where you can select the values for an action parameter cell. If you select the **Always Selected** checkbox, all the checkboxes for the particular action form get selected. All the checkboxes pertaining to the action form are also disabled, because the specified action "is always selected".

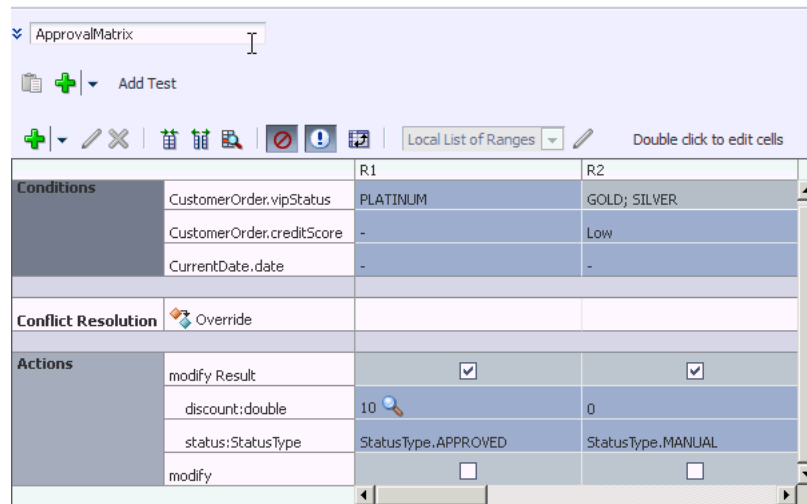
**Figure 12–72 The Action Editor Window**

The Action Editor window shows the configuration for an action. The form is set to 'Modify' and the value is 'Modify Result'. The target is 'CustomerOrder' with 'Result' selected. The arguments table is as follows:

Name	Type	Value	Parameterized	Constant
discount	double		<input checked="" type="checkbox"/>	<input type="checkbox"/>
status	StatusType		<input checked="" type="checkbox"/>	<input type="checkbox"/>
surcharge	double		<input checked="" type="checkbox"/>	<input type="checkbox"/>

The 'Always Selected' checkbox is currently unchecked. The 'Value' field for the 'surcharge' argument is highlighted.

**Note:** You can delete all the condition cells and all the action cells of a Decision Table at one go. Clicking the Conditions or the Actions box selects all the conditions or actions in the Decision Table respectively as shown in the following graphic.



You can then click the **Delete** icon on the Decision Table toolbar to delete the conditions or actions.

#### 12.8.4.2 Controlling the Order of Rules in a Decision Table

By default the **Order Rules by Bucket** checkbox is enabled in a Decision Table, as shown in Figure 12–68. This means the order of the buckets in the bucketset associated with a condition row determines the order of the condition cells, and thus the order of the rules.

To change the order of rules in a Decision Table, you need to change the order of buckets in the bucketsets. For example, you can control rule ordering in a Decision Table by changing the relative position of the buckets in an LOV bucketset associated with a condition row. Note, however, that you cannot reorder range buckets.

When the **Order Rules by Bucket** checkbox is selected in a Decision Table and you add a rule, by default the new rule is added as the first rule column; the other rule columns move as required to keep the bucket values in their defined order. When the **Order Rules by Bucket** checkbox is not enabled and you add a rule, the new rule is added as the last rule column. If you now select the **Order Rules by Bucket** checkbox, the newly added rule shifts to the first column.

### 12.8.5 Deleting Rules in a Decision Table

You can delete one or multiple rules in a Decision Table.

**To delete rules in a Decision Table:**

1. Select the rules column that you want to delete.
2. Click the **Delete** icon.

**To delete multiple rules in a Decision Table:**

1. Select a rule column that you want to delete.

2. Press the Ctrl key, and by keeping the key pressed, select the other rule columns as shown in [Figure 12-73](#).

**Figure 12-73** *Selecting Multiple Rules*

		R1	R2	R3
<b>Conditions</b>	CustomerOrder.vipStatus	PLATINUM	GOLD; SILVER	
	CustomerOrder.creditScore	-	Low	Medium
	CurrentDate.date	-	-	Before Promo; After Promo
<b>Conflict Resolution</b>	Override			
<b>Actions</b>	modify Result	<input checked="" type="checkbox"/>	<input checked="" type="checkbox"/>	<input checked="" type="checkbox"/>
	discount:double	10	0	5
	status:StatusType	StatusType.APPROVED	StatusType.MANUAL	StatusType.MANUAL
	modify	<input type="checkbox"/>	<input type="checkbox"/>	<input type="checkbox"/>

3. Click **Delete**.

## 12.8.6 Defining Tests in a Decision Table

In Oracle SOA Composer, you can define tests in a Decision Table by adding conditions to facts. For more information about defining tests and working with rule conditions, see [Section 4.3, "Working with Rules"](#).

---

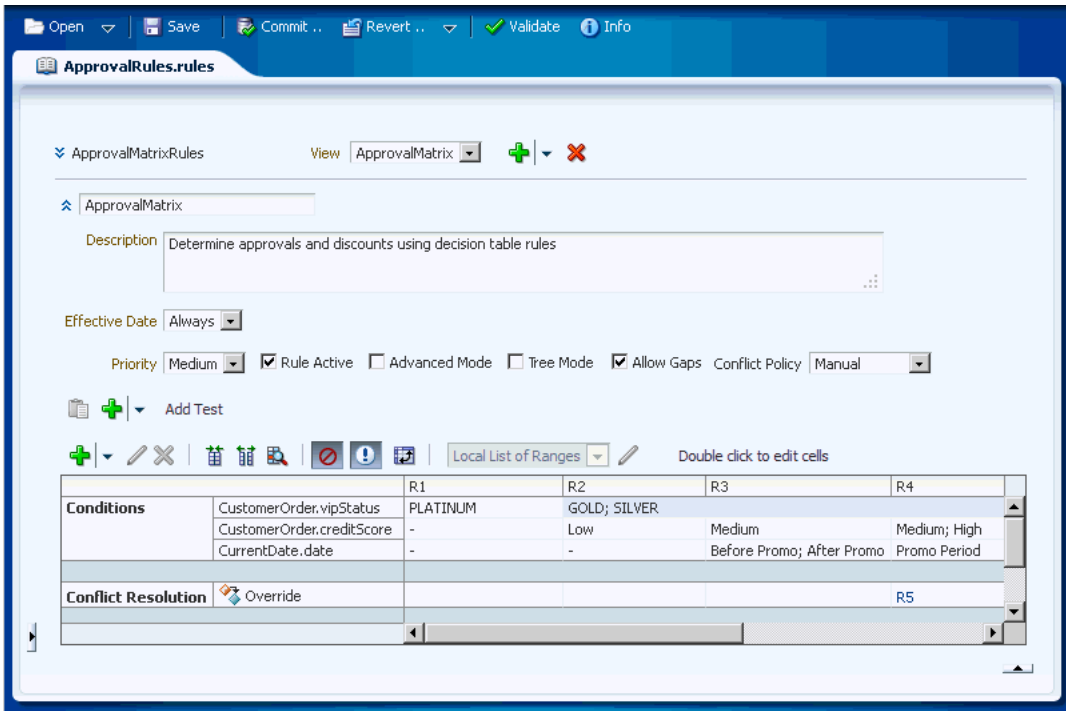
**Note:** To add more complex conditions to facts, see [Section 12.8.11, "Working with Advanced Mode Options in a Decision Table."](#)

---

### To add tests to a Decision Table:

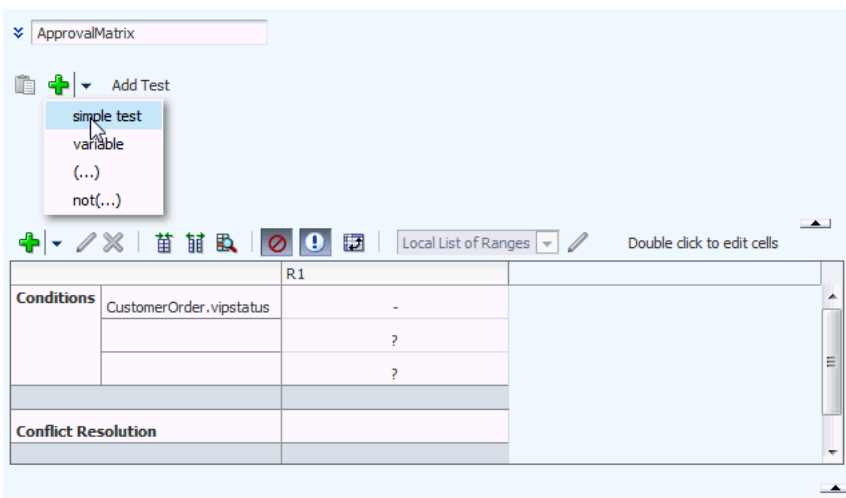
1. From Oracle SOA Composer, select a ruleset from the **Rulesets** navigation tab and select the Decision Table where you want to add a test.
2. Click the **Show Advanced Settings** icon (double downward pointing arrows) next to the Decision Table name. If **Advanced Mode** is selected, deselect the checkbox.

**Figure 12–74 Advanced Settings Area Expanded in a Decision Table**



3. Just above the Decision Table toolbar, click the **Add Test** downward pointing arrow.
4. Select any of the following options according to your requirement as shown in [Figure 12–75](#):
  - simple test
  - variable
  - nested test
  - not nested test

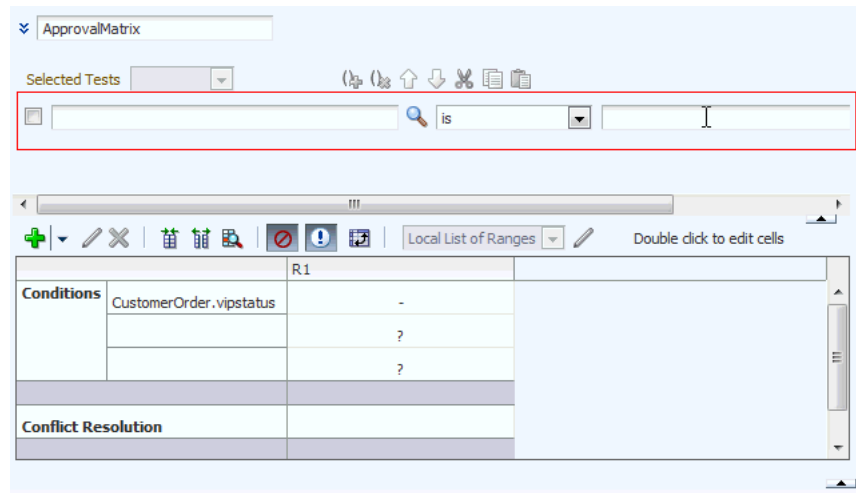
**Figure 12–75 Adding Tests**





5. Use the field controls or **Left Value** and **Right Value** icons, and the operator list to create the condition expression.

**Figure 12–76 Simple Test Added to a Decision Table**



**Note:** If a Decision Table already contains test conditions, you can add new test conditions by clicking the downward pointing arrow at the end of an existing condition and selecting the required test form type.

## 12.8.7 Splitting and Compacting a Decision Table

You can modify the contents of a Decision Table to create a table that includes a complete set of rules for all cases, or a table that provides the least number of rules for the cases. The split and compact operations enables you to manipulate the contents in a Decision Table.

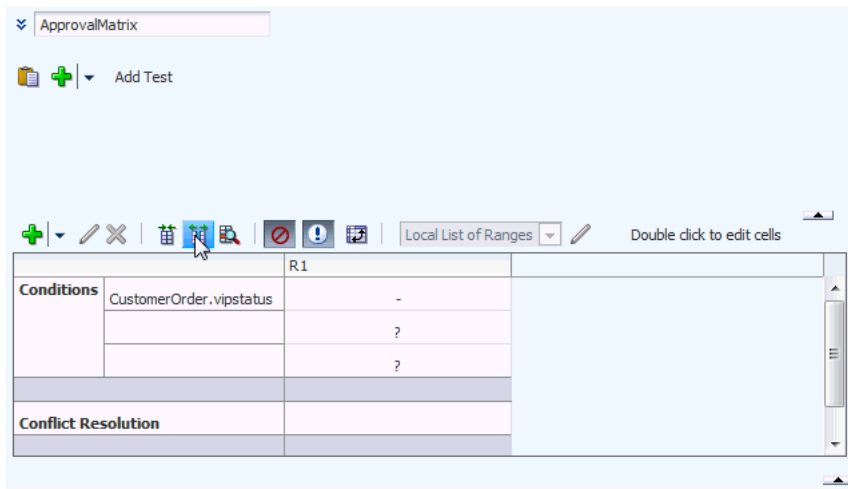
The split table operation creates a rule for every combination of buckets across the conditions. For example, in a Decision Table with 2 boolean conditions,  $2 \times 2 = 4$  rules are created. In a Decision Table with 20 boolean conditions,  $2^{20} \sim 1$  million rules are created. So, you only use split table when the number of rules created is small enough that filling in the action cells is feasible.

Using Oracle SOA Composer, split can be applied to an entire Decision Table. However, you cannot perform split operation on an individual condition row or cell.

### To split a Decision Table:

1. From Oracle SOA Composer, select a ruleset from the **Rulesets** navigation tab and select the Decision Table that you want to split.
2. Click the **Split Table** icon as shown in [Figure 12–77](#).

**Figure 12–77 Splitting a Decision Table**

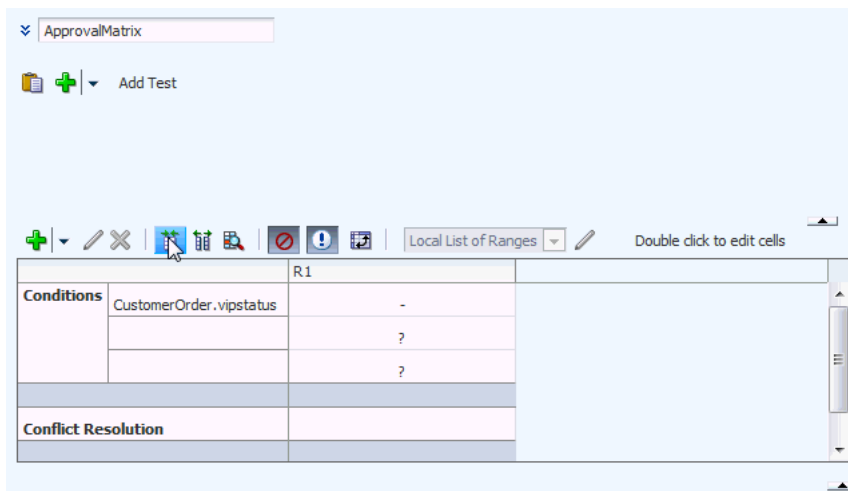


Using Oracle SOA Composer, you can compact a Decision Table by merging conditions of rules with identical actions. So, compacting a table enables you to remove conditions from a Decision Table. However, using Oracle SOA Composer, you cannot merge two or more condition cells.

**To compact a Decision Table:**

1. From Oracle SOA Composer, select a ruleset from the **Rulesets** navigation tab and select the Decision Table that you want to compact.
2. Select the **Compact Table** icon as shown in [Figure 12–78](#).

**Figure 12–78 Compacting a Decision Table**



For more information on splitting and compacting Decision Tables, see [Section 5.3, "Performing Operations on Decision Tables."](#)

### 12.8.8 Checking for Missing Rules in a Decision Table

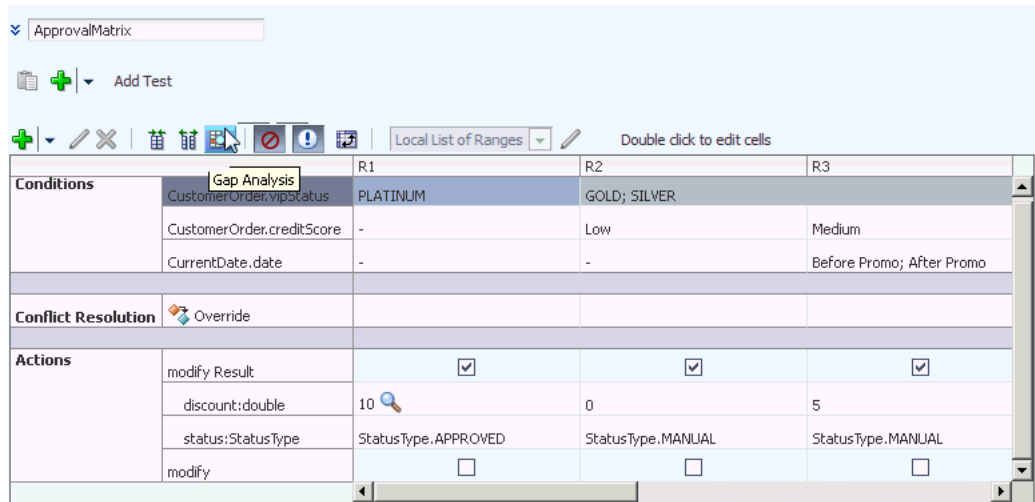
In a Decision Table, a "missing" rule is termed as a "gap." A gap in a Decision Table occurs when a rule does not cover some combinations of buckets, one from each condition.

Using Oracle SOA Composer, you can check for missing rules in Decision Tables.

**To check for missing rules:**

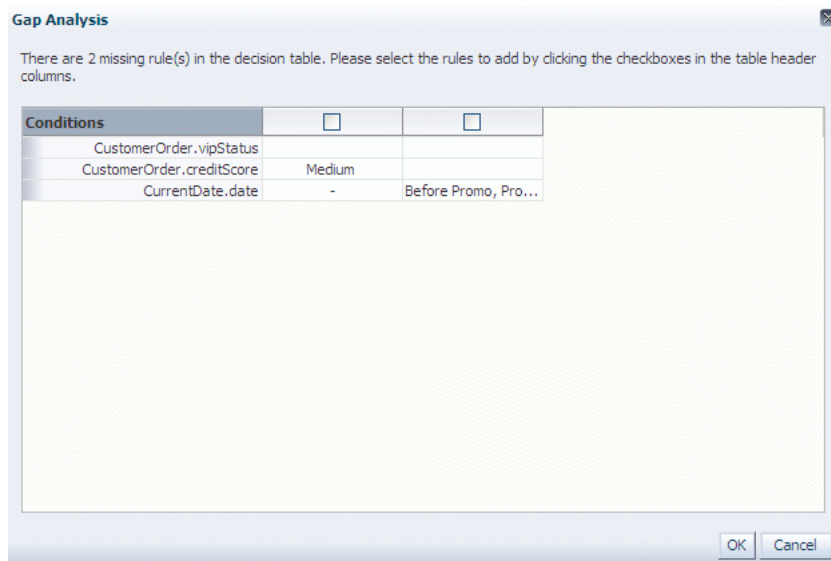
1. From Oracle SOA Composer, select a ruleset from the **Rulesets** navigation tab and select the Decision Table in which you want to check for missing rules.
2. Click the **Gap Analysis** icon on the Decision Table menu as shown in [Figure 12-79](#).

**Figure 12-79** Checking for Missing Rules in a Decision Table



The Gap Analysis window is displayed as shown in [Figure 12-80](#). You can select the rules that need to be added to the Decision Table.

**Figure 12-80** The Gap Analysis Window



For more information about checking for missing rules, see [Section 5.3.5, "How to Perform Decision Table Gap Checking."](#)

## 12.8.9 Performing Conflict Resolution in Decision Tables

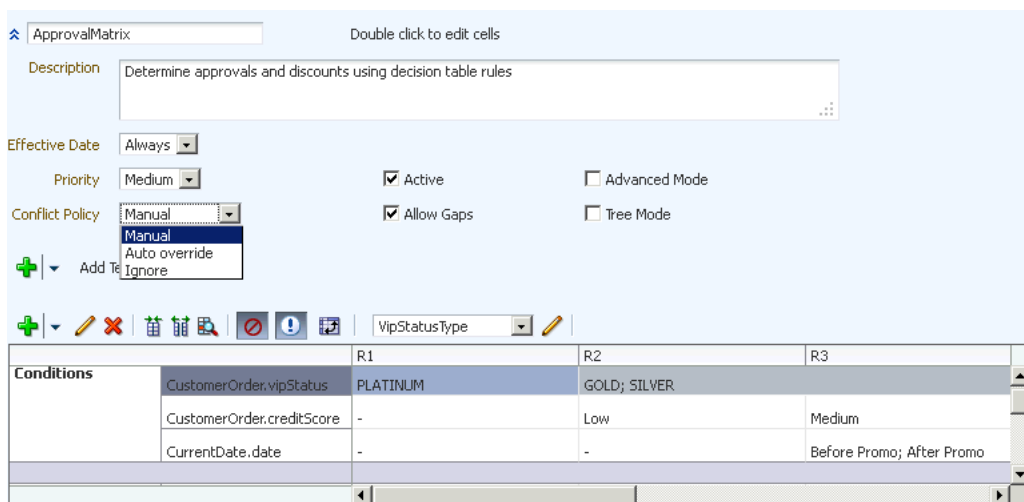
Rules in a Decision Table can conflict when they overlap and have different actions. Two rules overlap when at least one of their condition cells has a bucket in common. However, overlap without conflict is common and harmless. For more information about conflicts in Decision Tables, see [Section 5.3.1.4, "Understanding Decision Table Conflict Analysis."](#)

Using Oracle SOA Composer, you can find and resolve conflicts in a Decision Table.

### To perform conflict resolution in a Decision Table:

1. From Oracle SOA Composer, select a ruleset from the **Rulesets** navigation tab and select the Decision Table on which you want to perform the Conflict Resolution.
2. Ensure that the **Show Conflicts** icon is selected on the Decision Table toolbar.
3. Click the **Show Advanced Settings** icon (double downward pointing arrows) next to the Decision Table name.
4. Ensure that **Conflict Policy** is set to **Manual** in the Advanced Settings area as shown in [Figure 12–81](#). This is the default conflict policy.

**Figure 12–81** Setting the Conflict Policy



**Note:** For more information on conflict policies, see [Section 5.3.1.4, "Understanding Decision Table Conflict Analysis."](#)

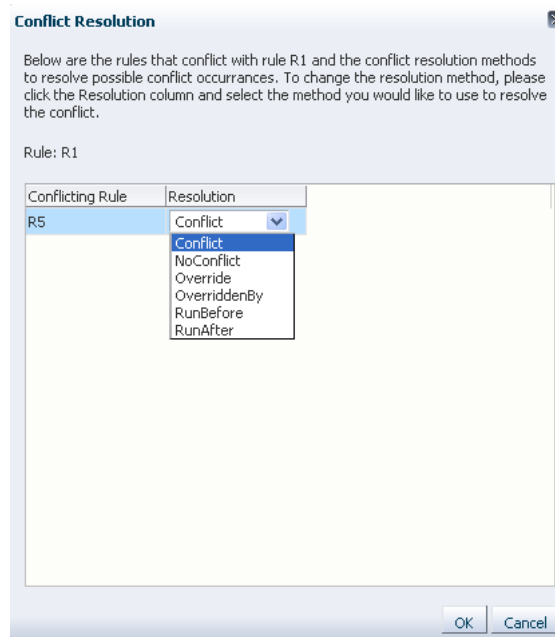
5. Select the **Conflict** row under **Conflict Resolution** and then click the rule that has a conflict to display the **Conflict Resolution** window as shown in [Figure 12–82](#).

**Figure 12–82 The Conflict Resolution Window**



6. In the Conflict Resolution window, for each conflicting rule, in the **Resolution** field select a resolution from the list and click **OK** as shown in [Figure 12–83](#).

**Figure 12–83 Options for Conflict Resolution**



For more information about the conflict resolution options in Decision Tables, see [Section 5.3.1.4, "Understanding Decision Table Conflict Analysis."](#)

## 12.8.10 Switching From Rows to Columns

In Oracle SOA Composer, you can turn the rows in a Decision Table to columns by clicking the **Switch Rows to Columns** icon on the Decision Table toolbar. This enables

the rules to be displayed as rows, and conditions, actions, and conflicts to be displayed as the columns.

Switching rows to columns provides ease of navigation when a Decision Table has many rules because you can see all the rules together and you do not need to "page the columns" for viewing the rules.

Figure 12–84 displays a Decision Table before the switch operation.

**Figure 12–84 A Sample Decision Table**

The screenshot shows a software interface for editing a decision table named 'ApprovalMatrix'. The table is organized into three main sections: Conditions, Conflict Resolution, and Actions. The 'Conditions' section has three columns labeled R1, R2, and R3. The 'Conflict Resolution' section has an 'Override' option. The 'Actions' section has four rows of actions: 'modify Result', 'discount:double', 'status:StatusType', and 'modify'. A tooltip 'Switch Rows to Columns' is displayed over the table header area.

		R1	R2	R3
<b>Conditions</b>	CustomerOrder.vipStatus	PLATINUM	GOLD; SILVER	
	CustomerOrder.creditScore	-	Low	Medium
	CurrentDate.date	-	-	Before Promo; After Promo
<b>Conflict Resolution</b>		Override		
<b>Actions</b>	modify Result	<input checked="" type="checkbox"/>	<input checked="" type="checkbox"/>	<input checked="" type="checkbox"/>
	discount:double	10	0	5
	status:StatusType	StatusType.APPROVED	StatusType.MANUAL	StatusType.MANUAL
	modify	<input type="checkbox"/>	<input type="checkbox"/>	<input type="checkbox"/>

Figure 12–85 displays the sample Decision Table after switching the rows to columns.

**Figure 12–85 Switching Rows to Columns**

The screenshot shows the same 'ApprovalMatrix' decision table after the 'Switch Rows to Columns' operation. The table is now oriented with conditions as columns and rules as rows. The 'Conditions' section has three columns: 'CustomerOrder.vipStatus', 'CustomerOrder.creditScore', and 'CurrentDate.date'. The 'Conflict Resolution' section has an 'Override' option. The 'Actions' section has four rows of actions: 'modify Result', 'discount:double', 'status:StatusType', and 'modify'. A tooltip 'Local List of Ranges' is visible over the table header area.

	<b>Conditions</b>			<b>Conflict Resolution</b>	<b>Actions</b>
	CustomerOrder.vipStatus	CustomerOrder.creditScore	CurrentDate.date	Override	modify Result
R1	PLATINUM	-	-		<input checked="" type="checkbox"/>
R2	GOLD; SILVER	Low	-		<input checked="" type="checkbox"/>
R3		Medium	Before Promo; After Promo		<input checked="" type="checkbox"/>
R4		Medium; High	Promo Period	R5	<input checked="" type="checkbox"/>
R5		High	-		<input checked="" type="checkbox"/>
R6	PLUTONIUM; null	-	-		<input checked="" type="checkbox"/>

### 12.8.11 Working with Advanced Mode Options in a Decision Table

In Oracle SOA Composer, you can use advanced mode rules in a Decision Table just like you can work with advanced mode rules in a ruleset. The Advanced Mode rules options enable you to create, modify, and delete patterns, as well as add, modify, and delete conditions and actions within a pattern. For more information about advanced mode rules, see [Section 4.7, "Working with Advanced Mode Rules"](#).

---

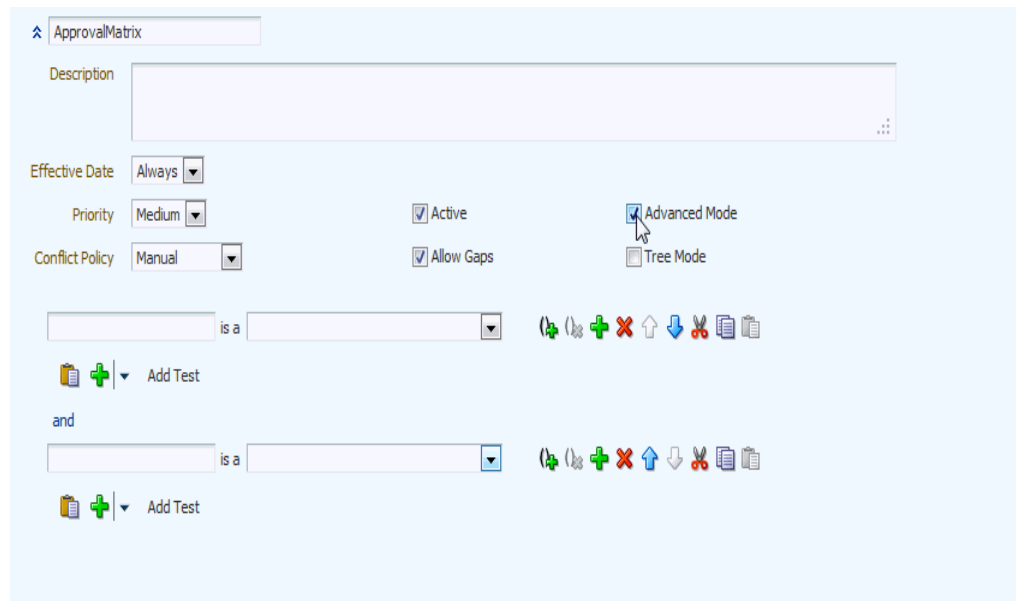
**Note:** To add a simple test using the <insert test> link above the Decision Table, see [Section 12.8.6, "Defining Tests in a Decision Table."](#)

---

**To show and use advanced mode options:**

1. From Oracle SOA Composer, select a ruleset from the **Rulesets** navigation tab and select the Decision Table on which you want to add more complex rules.
2. Click the **Show Advanced Settings** icon (double downward pointing arrows) next to the Decision Table name.
3. Select **Advanced Mode**.

**Figure 12–86** *Advanced Mode Enabled in a Decision Table*



The advanced mode options in a Decision Table are similar to the advanced mode options in a ruleset. For more information, see [Section 12.6.11.1, "Working with Advanced Mode Options."](#)

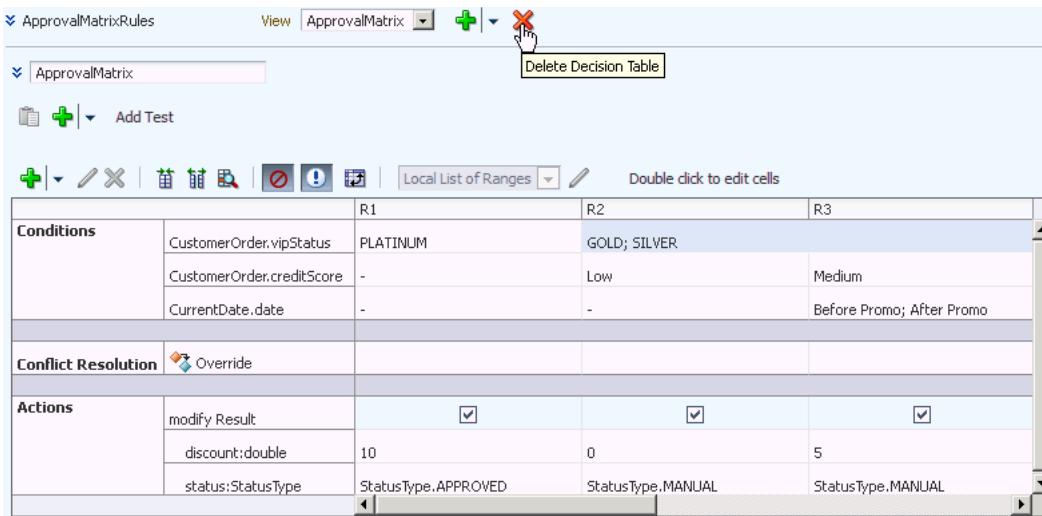
## 12.8.12 Deleting a Decision Table at Runtime

In Oracle SOA Composer, you can delete Decision Tables in a ruleset. For more information on working with Decision Tables, see [Section 5.1, "Introduction to Working with Decision Tables."](#)

**To delete a decision table in a ruleset:**

1. In edit mode, select a ruleset of interest.
2. In the ruleset area, in the **View** field from the list, select the Decision Table you want to delete.
3. Click **Delete Decision Table** as shown in [Figure 12–87](#).

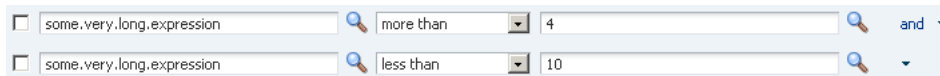
**Figure 12–87 Select the Delete Decision Table Icon**



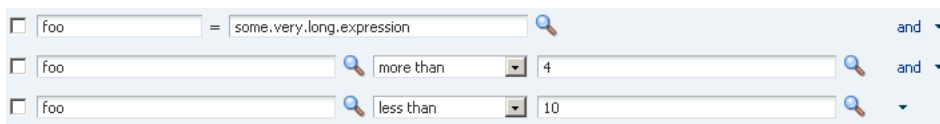
### 12.8.13 What You Need to Know About Rule Test Variables

Oracle SOA Composer enables you to define test variables that provide a way to shorten lengthy expressions that occur in rule and decision table conditions and actions. The variable and its value can be represented as an inline business term definition. The test variables are also called inline aliases.

So, instead of writing:



You can write:



In subsequent test conditions, you can use `foo` as part of your expressions. The expression can be anything from a simple to a complex expression.

To define a variable, in the IF section of a rule, you need to click the down arrow adjacent to **Add Test**, and select **variable** from the list.

Apart from variables, you can also define other test form types, such as simple test, nested tests (`((...))`), and not nested tests (`not (...)`).

## 12.9 Localizing Names of Resources in Oracle Business Rules

Oracle BPM enables you localize the names of some rules components. Providing a translated version of these aliases enables users to view these aliases based on the local setting of their browser when using the following applications:

- Oracle SOA Composer
- Oracle Business Process Composer
- Oracle Process Workspace



---

**Note:** Locale dictionaries are stored as resource bundles. You must create the resource bundle using Oracle JDeveloper. They must be deployed as part of the SOA composite application.

Resource bundles cannot be created using Oracle SOA Composer. However, you can use Oracle SOA Composer to edit the localized strings within a resource bundle.

---

Oracle SOA Composer enables you to localize the aliases of the following rules components.

- Buckets
- Bucketsets
- Decision Functions
- Decision Function Facts
- Globals
- Links
- Rulesets
- Rules
- Patterns

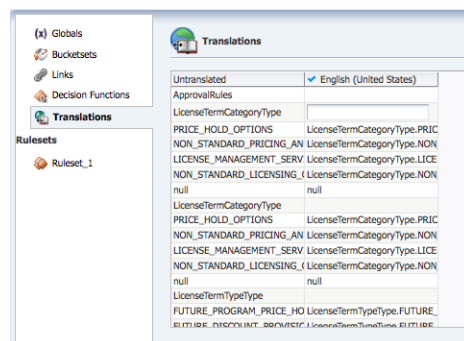
### 12.9.1 How to Localize the Alias of a Oracle Business Rules Component

Using Oracle SOA Composer, in the edit mode, you can add translated versions of the aliases and their descriptions used to identify rules components.

**To localize the alias of a rules component:**

1. In Oracle SOA Composer, select the **Translations** tab. The Translations tab displays a table with multiple columns. By default, there are two columns one displaying the untranslated identifier of the rules component. The other displays the English locale as shown in [Figure 12–88](#).

**Figure 12–88** The Translations Tab in Oracle SOA Composer



If you have defined other locales in your application, these also appear as columns in this table. See [Section 2.6, "Localizing Oracle Business Rule Resources."](#) for more information.

2. In the column of the locale you want to edit, double-click in cell corresponding to the alias you want to translate.
3. Enter the localized text for the alias.
4. Repeat steps 2 and 3 to localize all the aliases required for the locale.

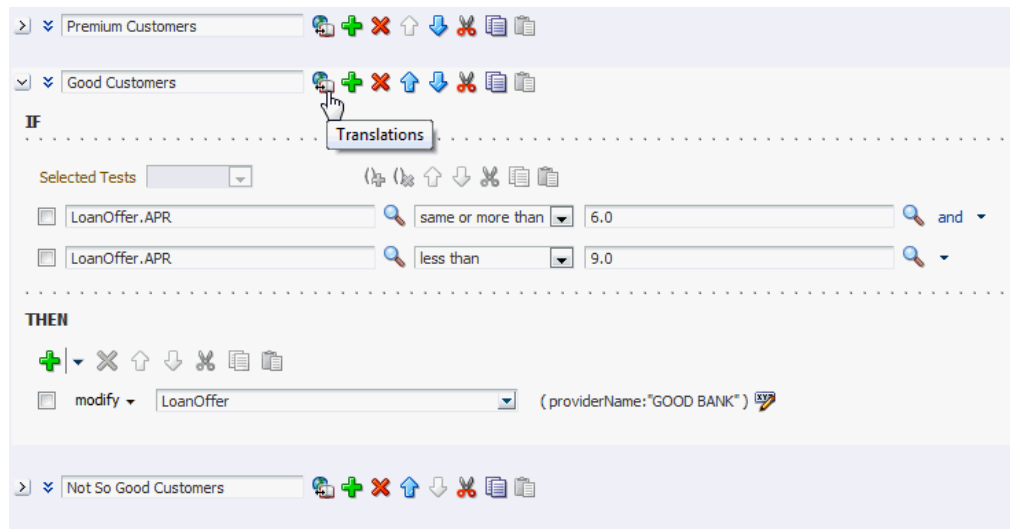
---

**Note:** Offline editing of locale files is not supported. When a locale is added, the xml file generated does not contain all the keys by default. They are added when a value is added.

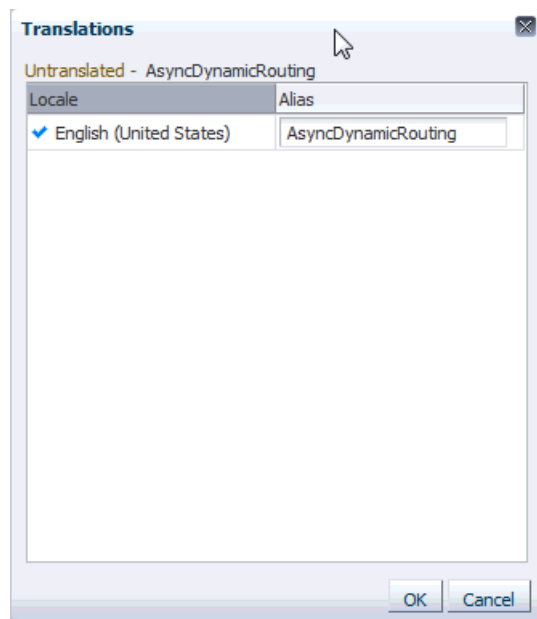
---

You can also localize from the editor. To localize from the editor click the Translations icon as shown in [Figure 12–89](#)

**Figure 12–89** *Translations Icon for Localizing from Editor*



Translations pop up appears as shown in [Figure 12–90](#). Enter the **Alias** for the rule components and click **OK**.

**Figure 12–90 Translations Editor**

## 12.10 Committing Changes for an Oracle Business Rules Dictionary at Runtime

After you verify dictionary modifications, you can commit those changes to the MDS repository.

### To commit changes to an Oracle Business Rules dictionary:

1. Click the **Commit** menu item.
2. In the Confirm dialog, click **No** if you do not want to make the changes in the MDS repository.
3. In the Confirm dialog, click **Yes** if you do want to make the changes in the MDS repository.

Remember to update the runtime changes into Rule Editor ADF following the tasks described in [Section 4.12, "Importing Runtime Rules Changes From Repository Into JDeveloper"](#)

4. When you open the dictionary after saving the edit session and deploying the composites, SOA composer opens the last saved edit session. To open the new dictionary click **Revert, Clear all session edits and save changes** button in the top menu.

---

**Note:** A dictionary with validation errors can be saved, but it can be committed only after correcting the validation issues.

---

### 12.10.1 What You Need to Know About Editing With Multiple Users at Runtime

When multiple users are editing the same dictionary, Oracle SOA Composer shows a message that the dictionary is being edited by another user and asks for a confirmation. When multiple users work on a single dictionary, only the last commit is persisted.

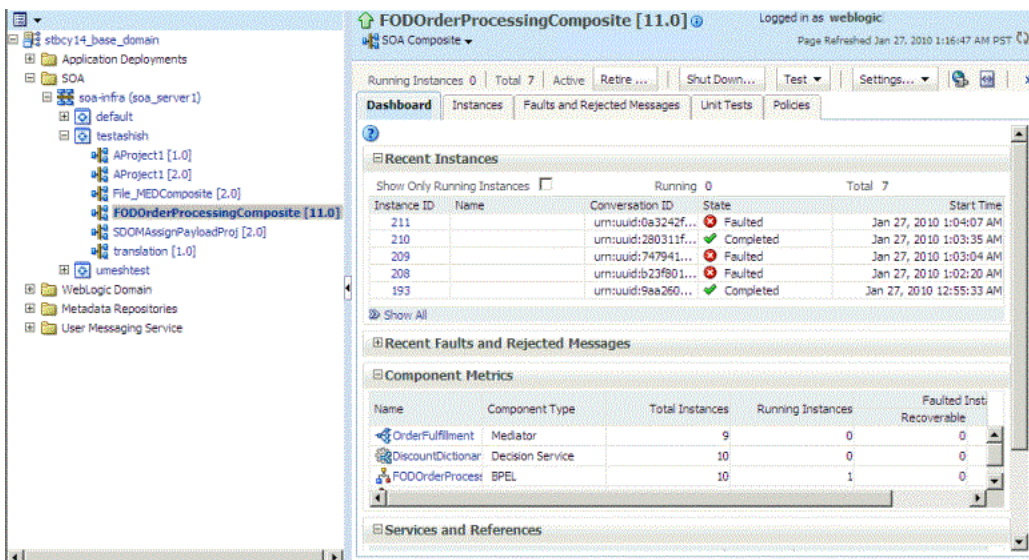
## 12.11 Synchronizing Rules Dictionary in Oracle JDeveloper With Runtime Dictionary Updates

Oracle SOA Composer enables you to update rules dictionaries at runtime. However, the modifications made to the dictionaries through Oracle SOA Composer are not automatically reflected in Oracle JDeveloper. To synchronize the dictionary updates made in Oracle SOA Composer with the dictionaries available in Oracle JDeveloper, you must select the **Export** option in Oracle Enterprise Manager Fusion Middleware Control Console. This utility allows you to export the SOA composite application along with the dictionary.

To select the **Export** option in Fusion Middleware Control Console:

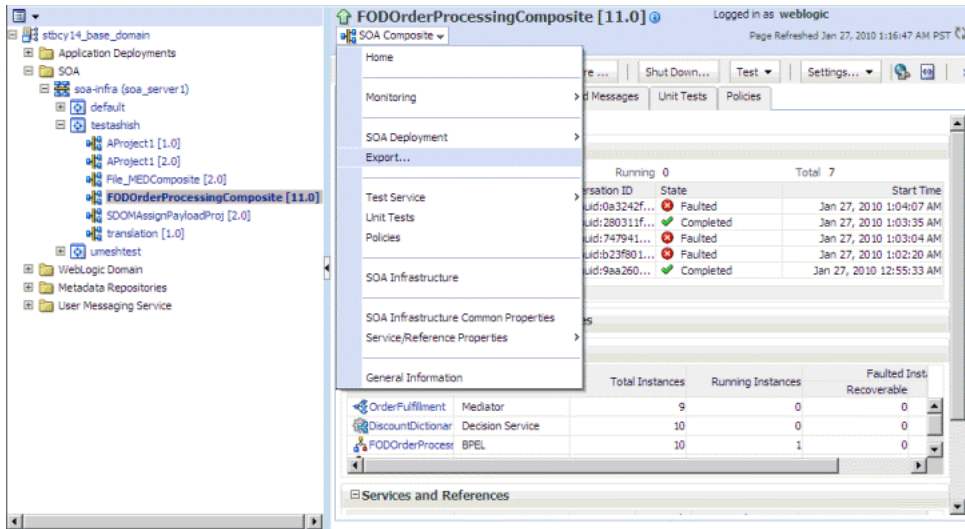
1. In Fusion Middleware Control Console, select the composite that contains the dictionary to be exported. [Figure 12–91](#) displays the selected composite in Fusion Middleware Control Console.

**Figure 12–91** Opening the SOA Composite



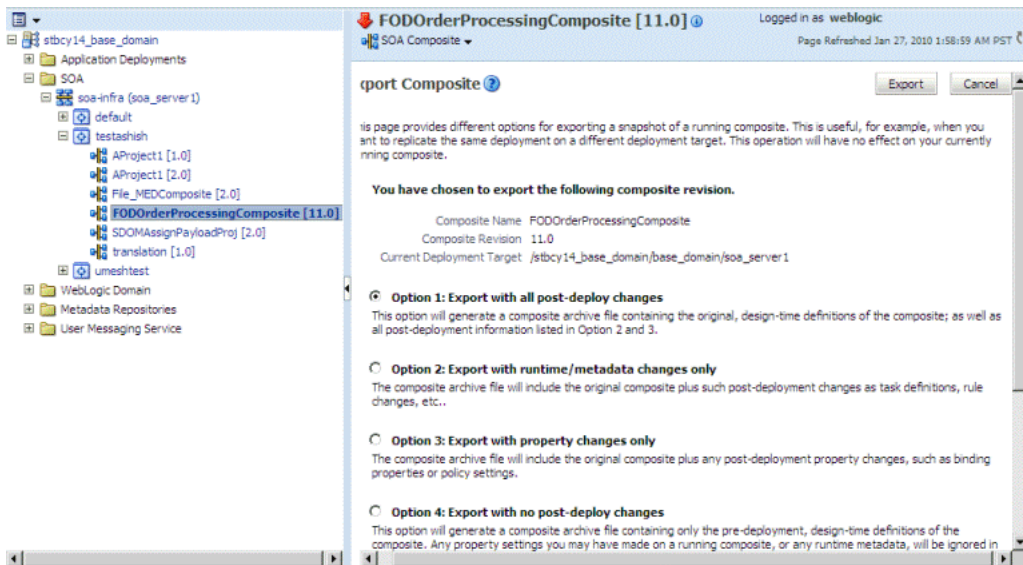
2. Click **SOA Composite** drop-down list on the right panel and select **Export** as shown in [Figure 12–92](#).

Figure 12–92 Selecting the Export Utility



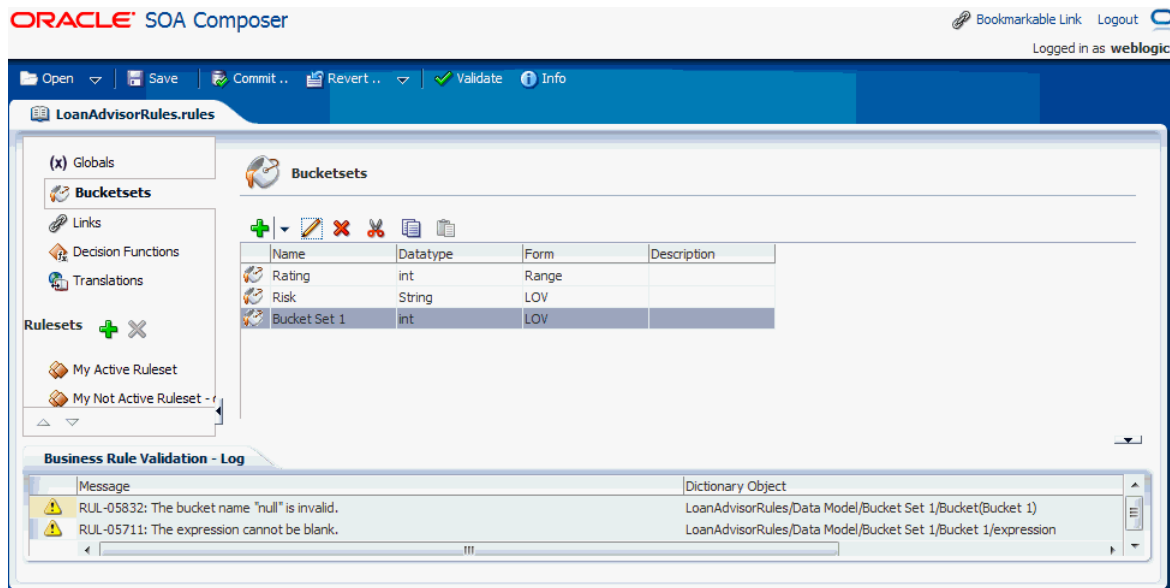
3. Select **Option 1: Export with all post-deploy changes** from the Export Composite page and click **Export** as shown in Figure 12–93.

Figure 12–93 Exporting All Postdeployment Changes



## 12.12 Validating an Oracle Business Rules Dictionary at Runtime

In Oracle SOA Composer, in the Edit mode, you can validate a dictionary for errors. The dictionary level validation errors are displayed in a Validation Panel in the bottom of Oracle SOA Composer window as shown in Figure 12–94.

**Figure 12–94 The Validation Panel**

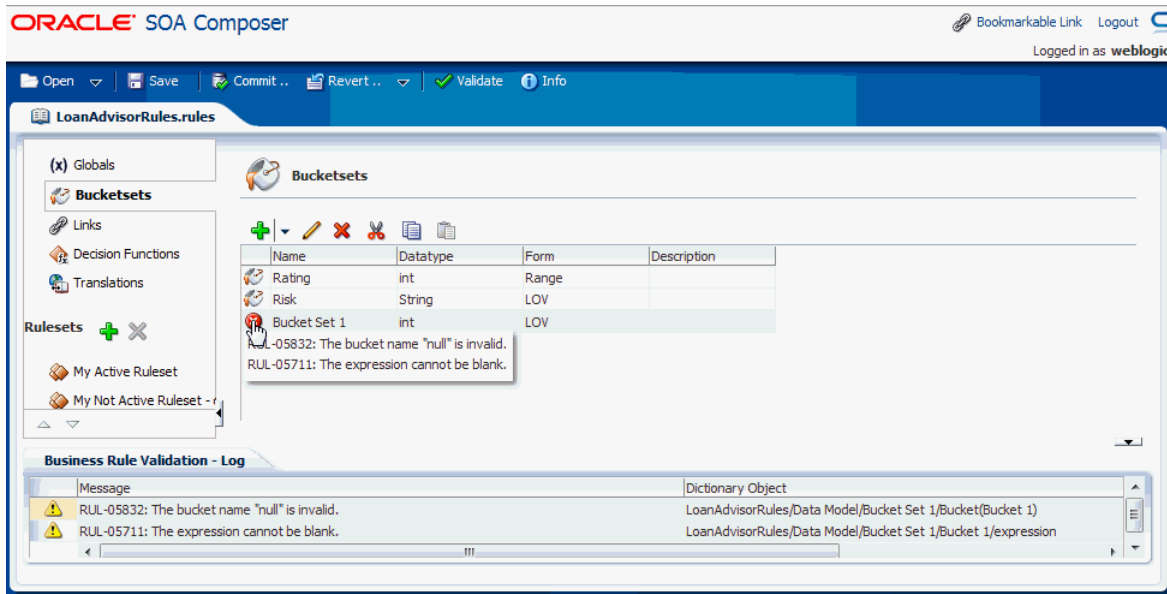
**Note:** When you open rules in Oracle SOA Composer, the Validation panel remains in the collapsed state. If you click the Validate button on the Oracle SOA Composer toolbar, the Validation Panel is expanded, and it remains in the expanded state during subsequent user interactions.

However, if you manually collapse the Validation Panel or drag the panel separator, the working of the automatic collapse and expand cannot be guaranteed.

### 12.12.1 Understanding the Validation Panel

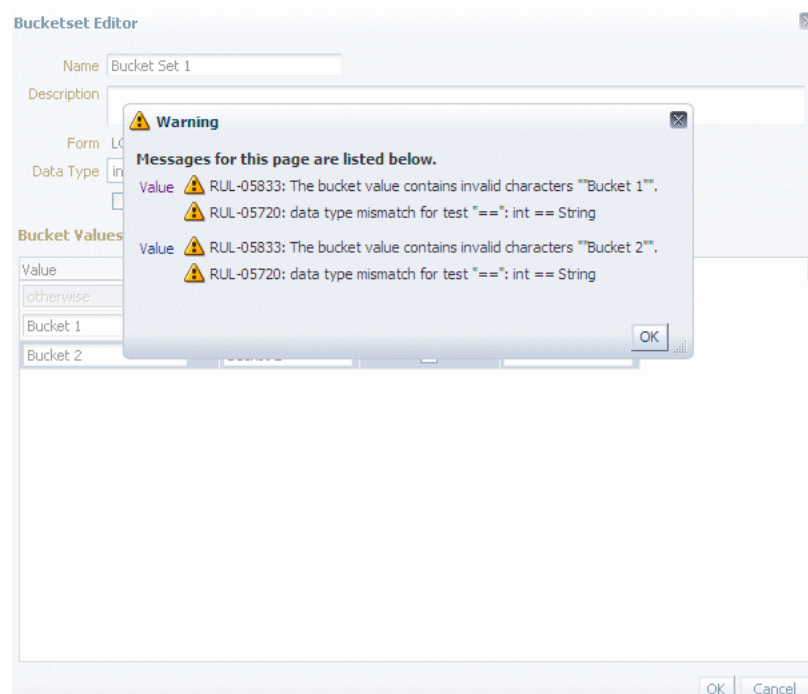
The Validation Panel lists all the dictionary-level validation errors. When you double-click a row in the Validation Panel, Oracle SOA Composer leads you to the erroneous component. For example, if a Bucket or a Bucketset error is double-clicked in the Validation Panel, Oracle SOA Composer switches to the **Bucketsets** tab and displays the invalid icon next to the Bucketset name. You can move the mouse cursor over the invalid icon to see the list of error messages for that Bucketset as shown in [Figure 12–95](#).

**Figure 12–95 Bucketset Validation Error Messages**



When the Bucketset Editor window is displayed, the invalid fields are highlighted in the editor, and a pop-up containing the error messages are displayed, as shown in Figure 12–96.

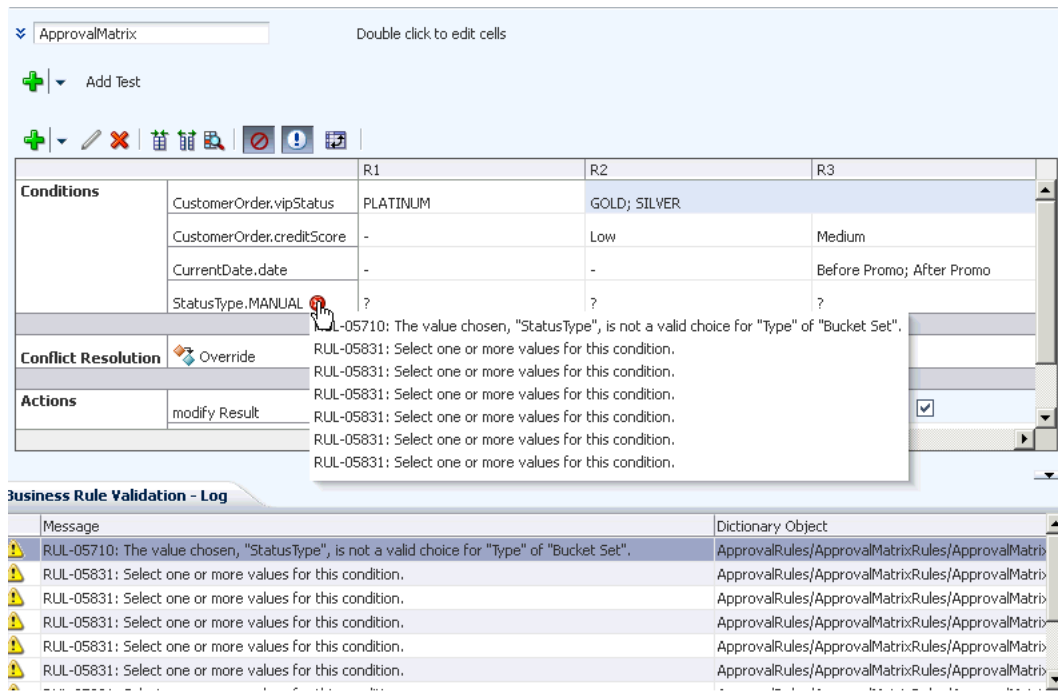
**Figure 12–96 Highlighted Error Entries in Bucketset Editor**



When you double-click an error pertaining to a Decision Table, the UI switches to the Decision Table UI and displays the error messages when you move the mouse cursor on the invalid icon as shown in Figure 12–97.

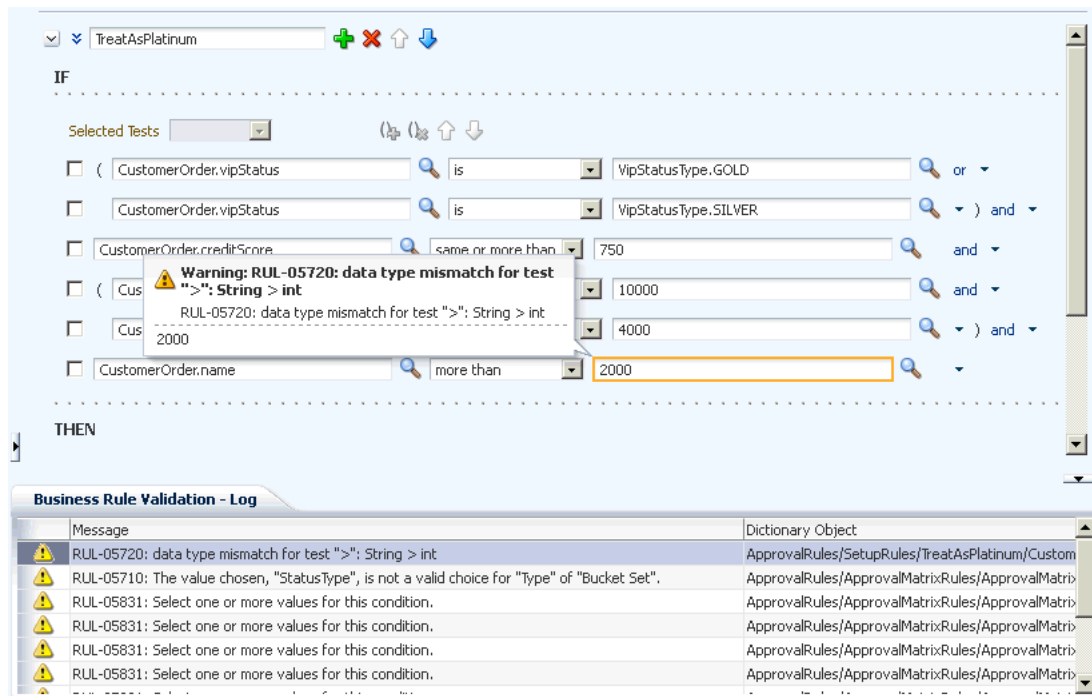


**Figure 12–97 Accessing the Erroneous Component**



Similarly, in the Validation Panel, if you double-click an error pertaining to a rule in a ruleset, the UI switches to the ruleset to which the rule belongs and highlights the erring fields of the rule. In addition, all the errors pertaining to the rule are displayed in a pop-up as shown in Figure 12–98.

**Figure 12–98 Rules Validation**



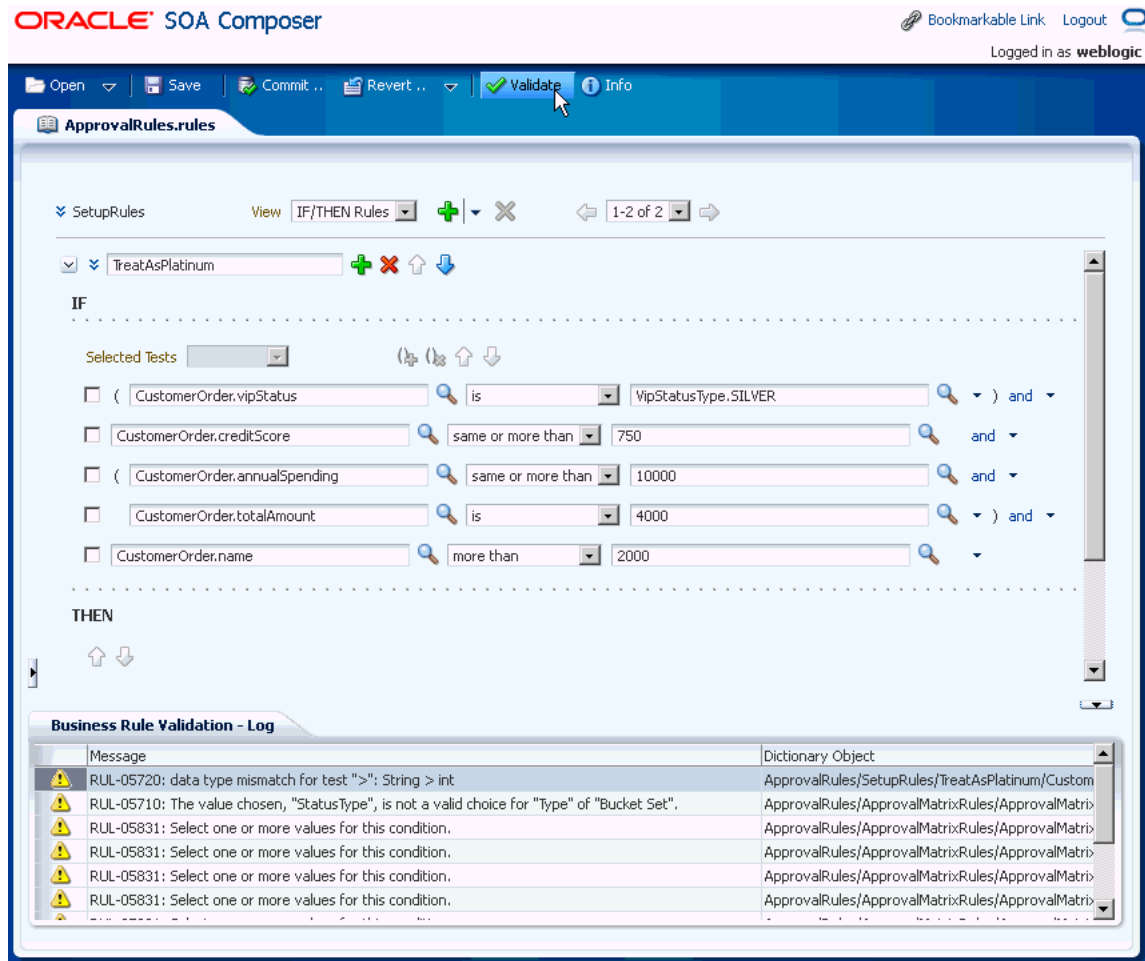


## 12.12.2 Updating the Validation Panel

The Validation Panel does not get updated automatically to display any new validation errors that may be generated due to any modification to the dictionary components.

For example, when a new rule is added with some errors, the Validation Panel is not updated automatically. You need to click the **Validate** button on the Oracle SOA Composer menu to update the Validation Panel with the new error entry, as shown in [Figure 12–99](#).

**Figure 12–99** The Validate Button

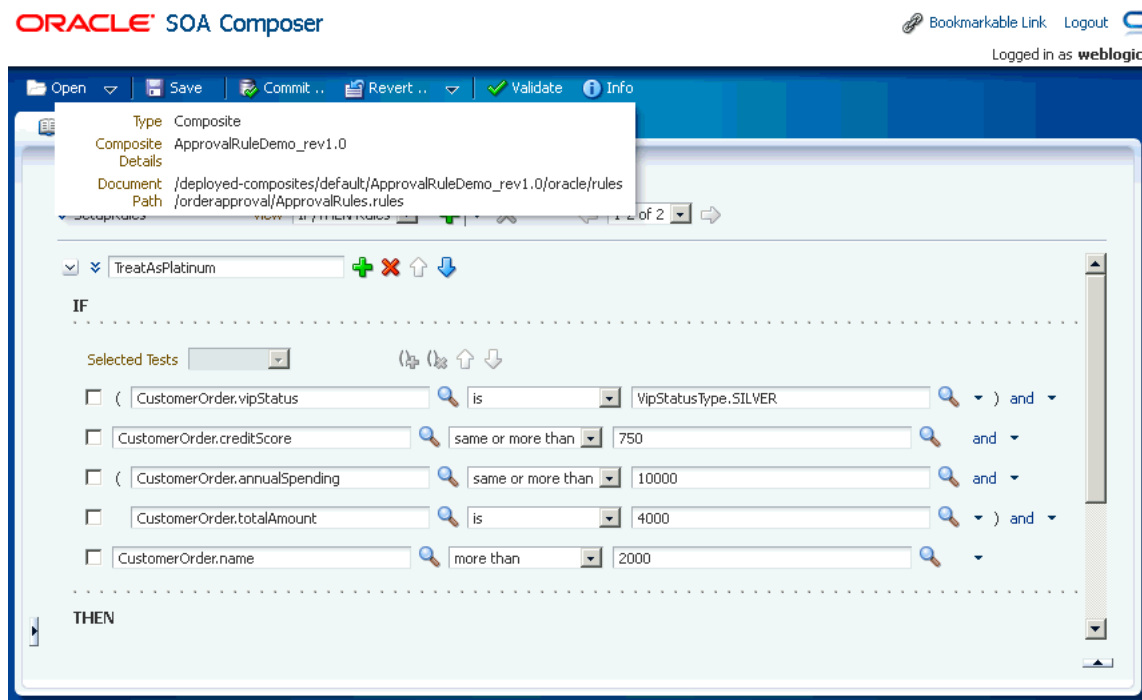


## 12.13 Obtaining Composite and Dictionary Information at Runtime

When a dictionary is open, you can obtain dictionary and composite details from the **Info** dialog.

### To obtain dictionary information:

1. With an open document, you can obtain the document type, composite details, and document path by clicking **Info**. This displays the Oracle SOA Composer open file information, as shown in [Figure 12–100](#).

**Figure 12–100 Using Info Dialog to Obtain the Document Path for an Open Dictionary**

## 12.14 Working with Tasks at Runtime

Using Oracle SOA Composer, you can view and edit tasks that may be or may not be associated to Approval Management Extensions (AMX) rules. AMX enables you to define complex task routing slips for human workflow by taking into account business documents and associated rules to determine the approval hierarchy for a work item. Additionally, AMX lets you define multi-stage approvals with associated list builders based on supervisor or position hierarchies. At design time, you can define the approval task in the Human Task Editor of Oracle JDeveloper, and associate the task with a BPEL process. For more information about approval management and tasks, see "Using Approval Management" in *Oracle Fusion Middleware Modeling and Implementation Guide for Oracle Business Process Management*.

In Oracle SOA Composer, the Task Editor is embedded as a task flow so that you can view and perform all the task metadata lifecycle operations.

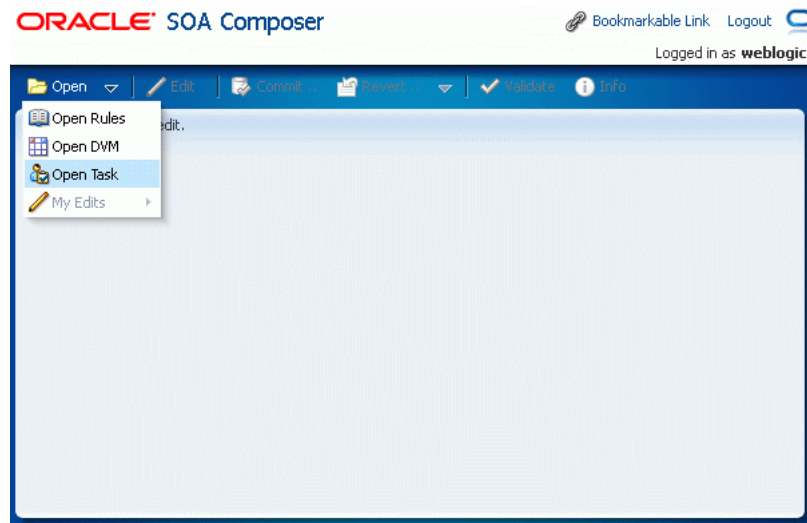
### 12.14.1 How to View Task Metadata at Runtime

In Oracle SOA Composer, you can open a task or an AMX rules metadata with the **Open** menu.

#### To open a task or an AMX rule using the Open menu:

1. In Oracle SOA Composer, from the **Open** menu, select **Open Task** as shown in [Figure 12–101](#). Oracle SOA Composer connects to the MDS and displays the **Select a Task to open** dialog box. This dialog box lists the available composite applications that contain tasks and AMX rules.

Figure 12–101 Opening a Task




---

**Note:** You can differentiate between traditional rules and AMX rules depends on the naming convention.

For example, if a composite has the following artifacts:

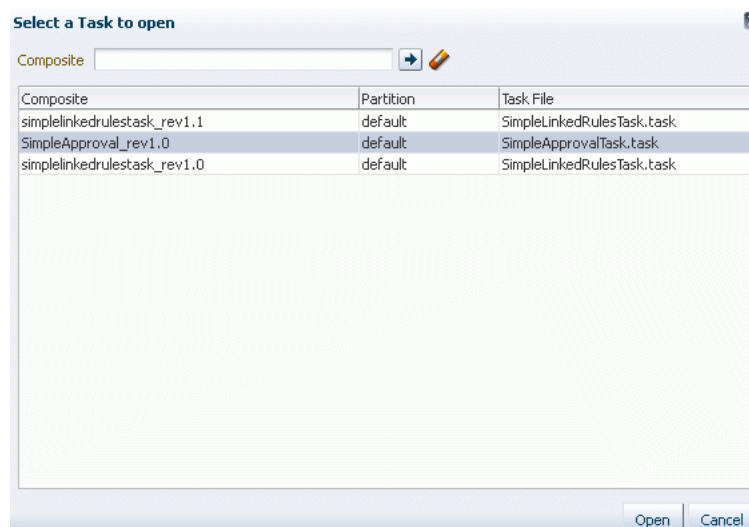
- `<AMX task name>.tsk`
- `<AMX rule name>Rules.rules`

In this case, the Rules.rules file is an AMX rules file associated with an AMX task, and so, is displayed as a part of an AMX task in the list of **Select a Task to open**, and not as a part of an ordinary Oracle Business Rules listing.

---

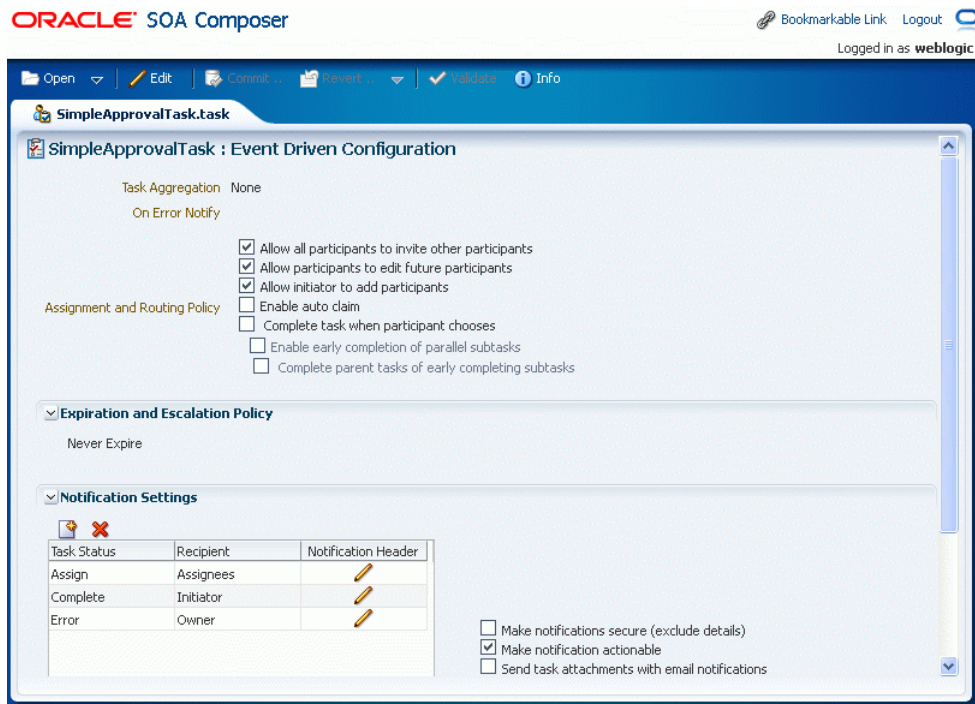
2. In the **Select a Task to open** dialog box, to open a task or AMX rule, select an entry in the table and click **Open**, or double-click an item as shown in [Figure 12–102](#).

Figure 12–102 Selecting a Task to Open

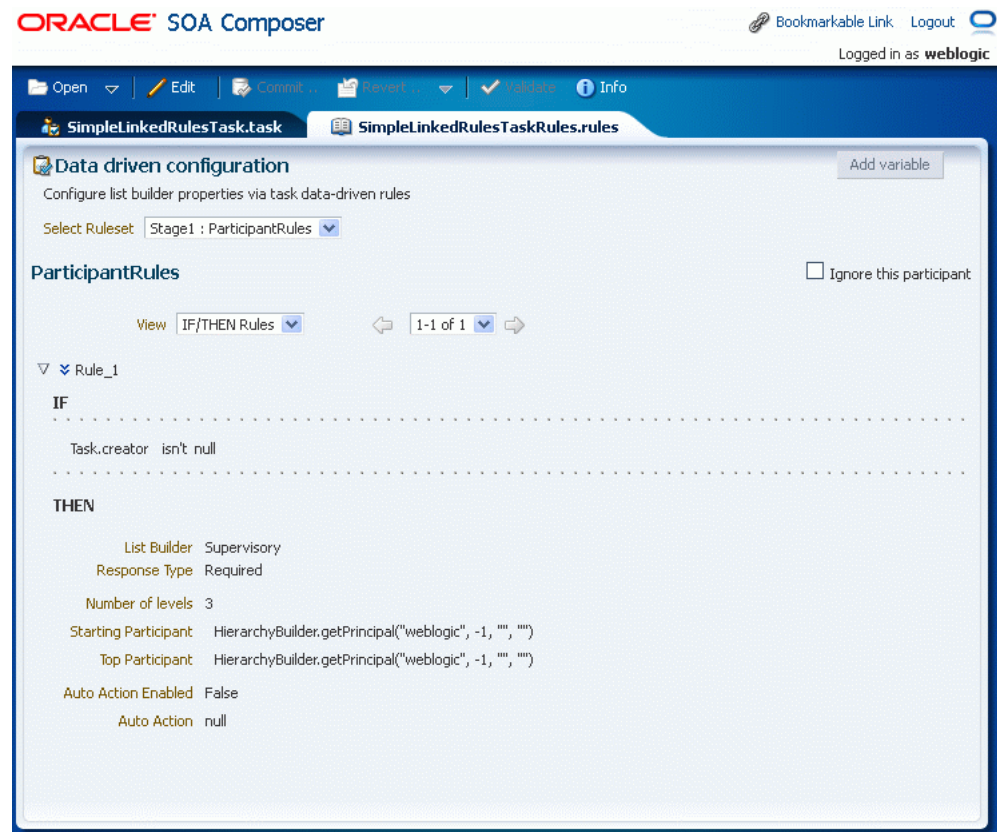


If the composite that you have selected only has a task and no associated AMX rule or ruleset, then the task window is displayed as shown in [Figure 12-103](#).

**Figure 12-103 Oracle SOA Composer with Only Task Displayed**



If the composite contains a task and an associated AMX rule or ruleset, then Oracle SOA Composer displays both the task and the rule or ruleset in a tabbed window as shown in [Figure 12-104](#).

**Figure 12–104 Oracle SOA Composer with Both Task and AMX Rule**

## 12.14.2 How to Configure a Task or an AMX Rule Metadata at Runtime

Task Configuration enables business users and administrators to review the rules that were configured automatically by the workflow designer. These predefined rules can be changed for a specific customer based on the customer's applicable corporate policies.

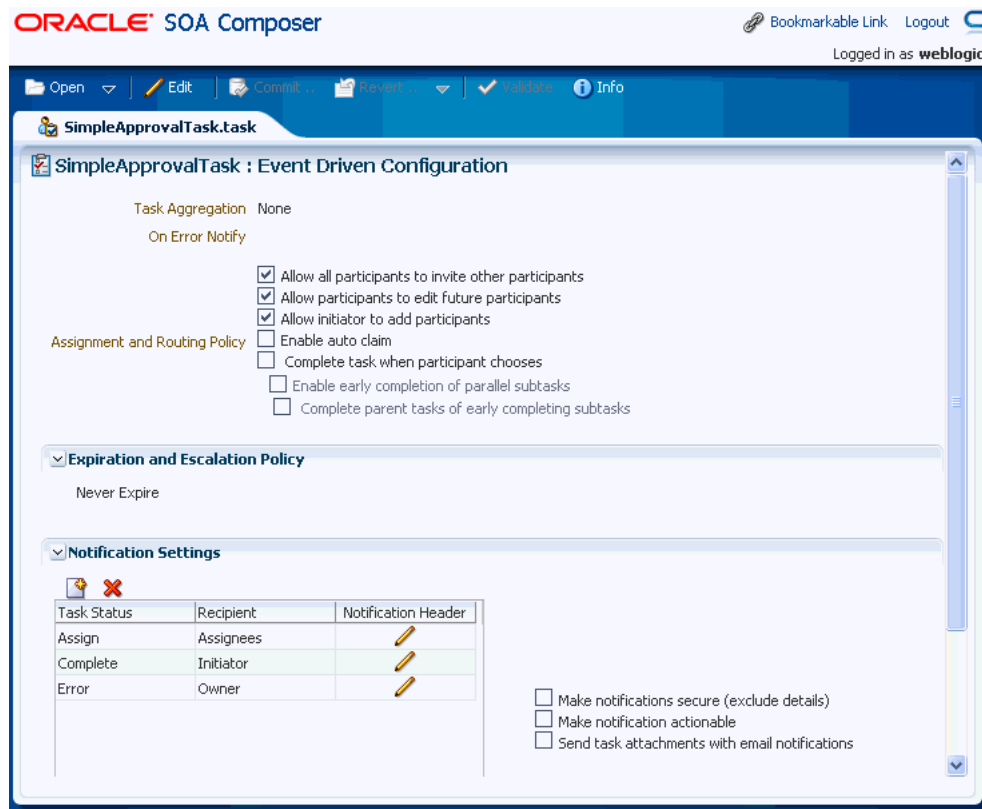
In Oracle SOA Composer, Task Configuration enables you to edit the event-driven (only tasks) and data-driven rules (tasks with an associated AMX rules) associated with an approval flow at runtime.

### 12.14.2.1 Configuring Event-Driven Settings

To configure event-driven settings:

1. Log on to Oracle SOA Composer and open the required task.
2. Click **Edit** on the Oracle SOA Composer menu bar to open the selected task for editing as shown in [Figure 12–105](#).

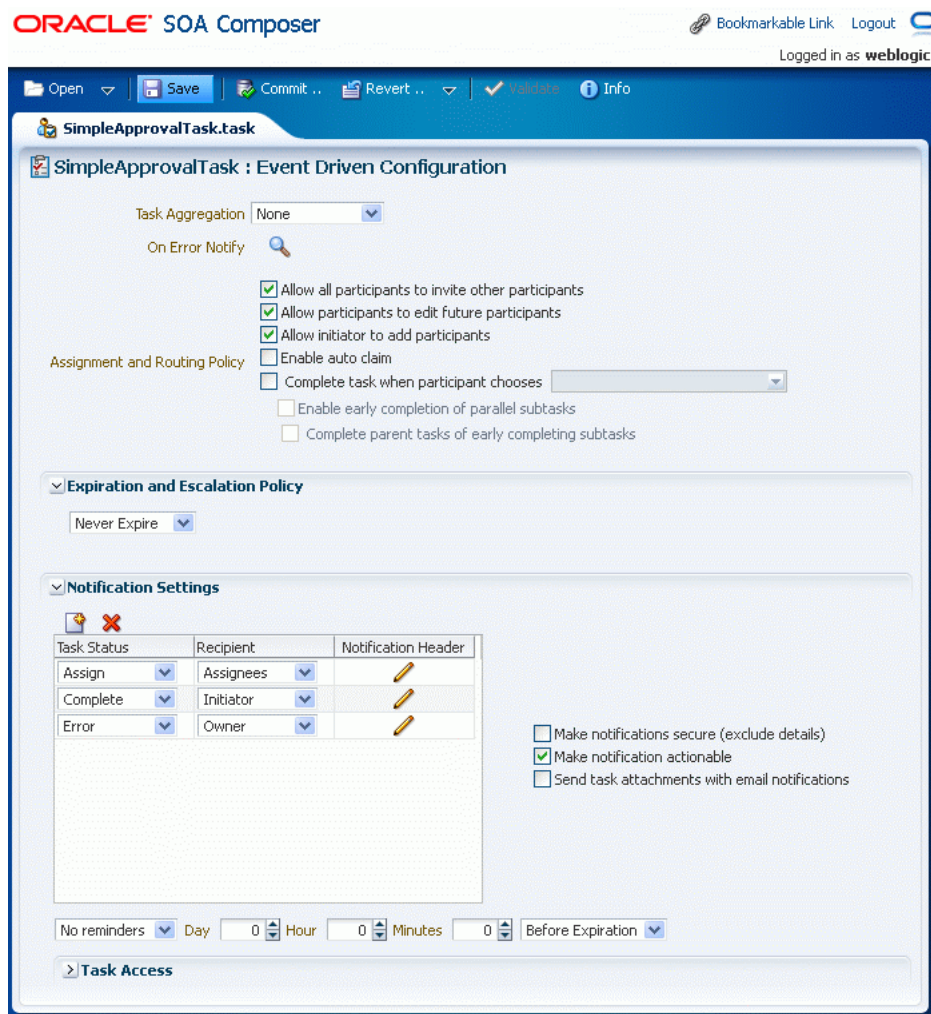
**Figure 12–105** Opening a Task for Editing



3. Make the relevant edits and click **Save** as shown in [Figure 12–106](#).



Figure 12–106 Saving Task Configuration



You can configure the following options and settings:

- Task aggregation
- Error notification
- Assignment and routing policy
- Expiration and escalation policy
- Notification settings
- Task access settings

### Setting Approval Aggregation Requirements

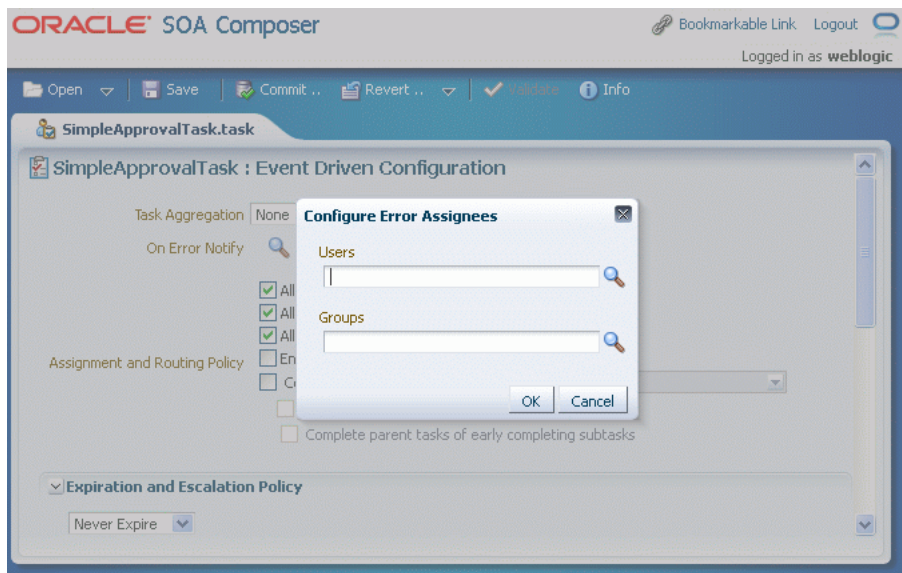
Task aggregation requirements can be any of the following:

- None
- Once per task
- Once per stage

### Notifying Errors

You can specify the user and group names that need to be notified in case of an error in the task. You need to click the On Error Notify search icon to display the Configure Error Assignees dialog box where you can specify the user or group names as shown in Figure 12–107.

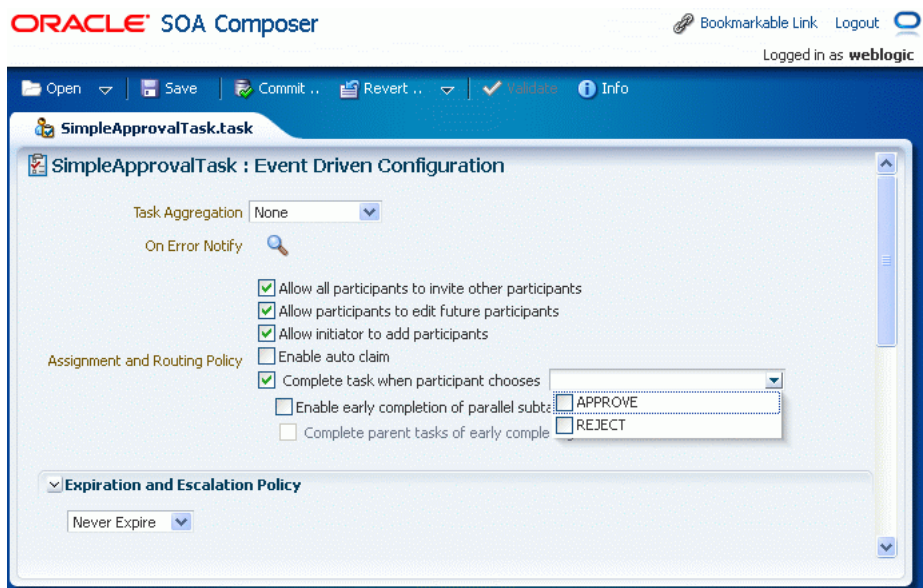
**Figure 12–107 Specifying Error Assignees**



### Setting Assignment and Routing Policy

You can set the assignment and routing policy by using the options available in Oracle SOA Composer. Figure 12–111 shows the available options for setting assignment and routing policy.

**Figure 12–108 Setting Assignment and Routing Policy**





For more information about the assignment and routing options available in event-driven configuration, see "Routing Policy Method" in *Oracle Fusion Middleware Developer's Guide for Oracle SOA Suite*.

### Setting Expiration and Escalation Policy

You can set the expiration and escalation policy for the task by using the available items in the **Expiration and Escalation Policy** list. The available list items are:

- Never Expire
- Expire After
- Escalate After
- Renew After

Figure 12–109 displays the list of options for setting the expiration and escalation policy.

**Figure 12–109** Setting Expiration and Escalation Policy

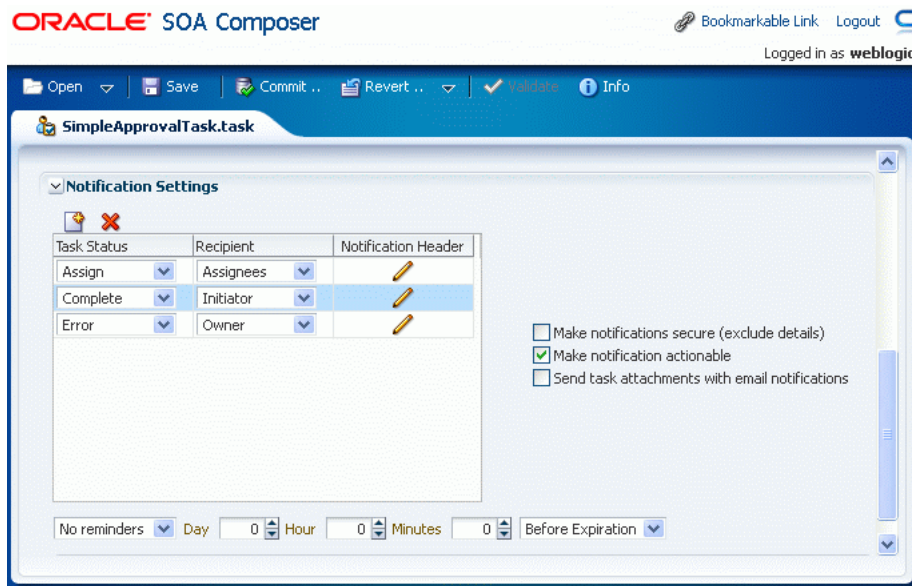


### Configuring Notification Settings

You can configure notification settings for a task by using the options available in the Notification Settings section of Oracle SOA Composer.

Figure 12–110 displays the different options available to configure notification settings for a task.

**Figure 12–110 Specifying Notification Settings**

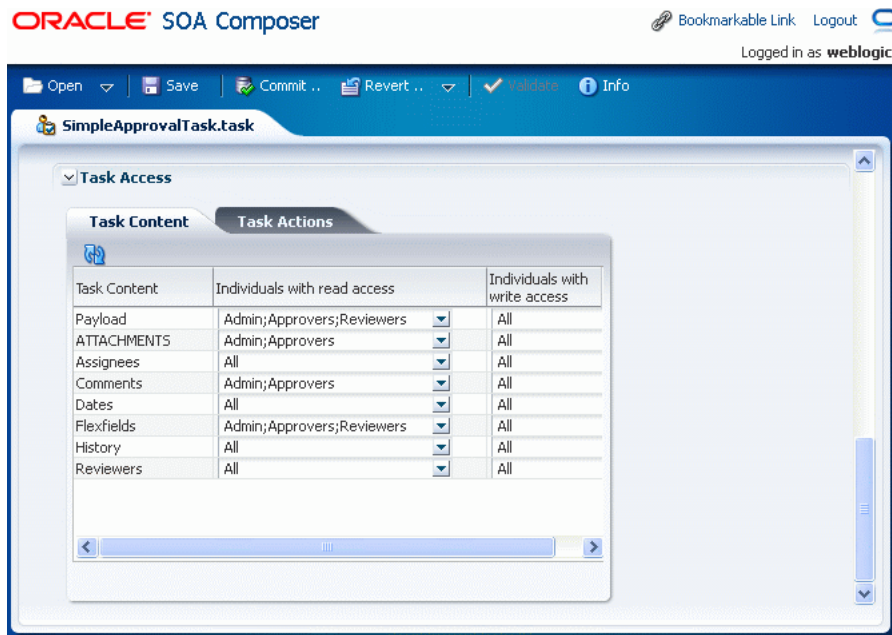


### Configuring Task Access Settings

You can set access-rule settings to control the actions a user can perform. You can also specify content and action permissions based on the logical role of a user, such as creator (initiator), owner, assignee, and reviewers.

In Oracle SOA Composer, you can set access settings by using the options available under Task Access as shown in Figure 12–111.

**Figure 12–111 Specifying Task Access Settings**



For more information on configuring task access, see "How to Define Security Access Rules" in *Oracle Fusion Middleware Modeling and Implementation Guide for Oracle Business Process Management*.

### 12.14.2.2 Configuring Data-Driven Settings (Rule or Condition)

To configure data-driven settings:

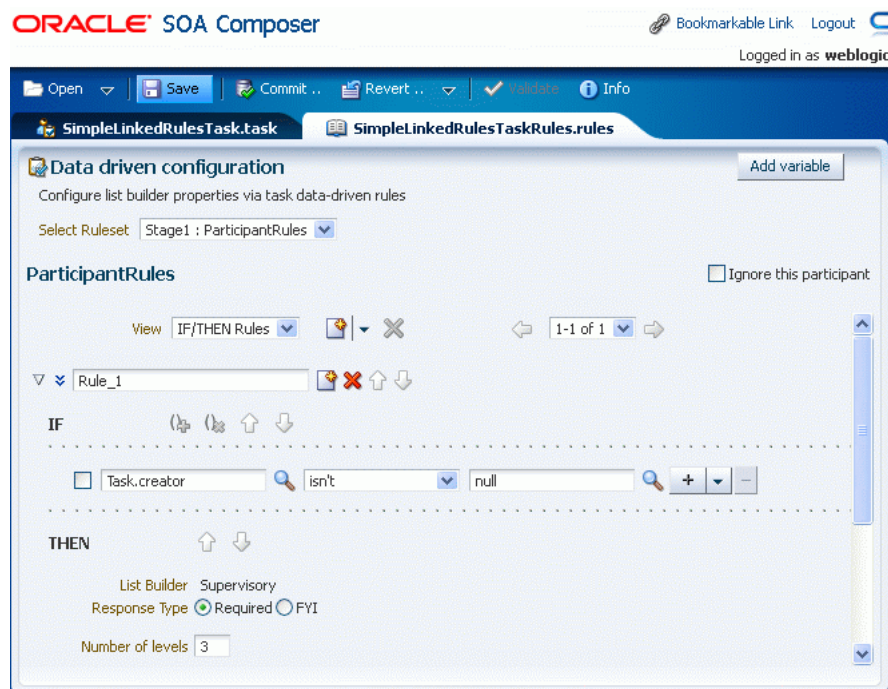
1. Log on to Oracle SOA Composer and open the required task.
2. Click **Edit** on the Oracle SOA Composer menu bar to open the selected AMX rule-associated task for editing as shown in [Figure 12-112](#).

**Figure 12-112** Opening an AMX Rule for Editing



3. Make the relevant edits and click **Save** as shown in [Figure 12-113](#).

**Figure 12-113** Saving AMX Rule Configuration



You can perform the following actions:

- Adding, updating, and deleting a rule
- Changing rule assertions (which depend on the type of list builder for which the rule has been configured)
- Adding a variable

For more information about editing data-driven settings, see "How to Edit Data-Driven Settings" in *Oracle Fusion Middleware User's Guide for Oracle Business Process Management*.

---

# Oracle Business Rules Files and Limitations

This appendix lists known naming constraints for Rules Designer files and names, and certain Rules SDK limitations.

This appendix includes the following sections:

- [Section A.1, "Rules Designer Naming Conventions"](#)

## A.1 Rules Designer Naming Conventions

This section covers Rules Designer naming conventions.

### A.1.1 Ruleset Naming

Rules Designer enforces a limitation for ruleset names; a ruleset name must start with a letter and contain only letters, numbers, or the following characters: ".", "-", "\_", ":", "/", and single spaces. Letters include the characters (a to z and A to Z) and numbers (0 to 9).

### A.1.2 Dictionary Naming

Rules Designer dictionary names can contain only the following characters, upper and lowercase letters (a to z and A to Z), numbers (0 to 9), and the underscore (\_). Special characters are not valid in a dictionary name.

Rules Designer dictionary names are case preserving but case-insensitive. For example, the dictionary names `Dictionary` and `DICT` are both valid. If you create a dictionary named `Test`, then you can create another dictionary named `TEST` only if you first delete the dictionary named `Test`.

### A.1.3 Alias Naming

Rules Designer alias names must begin with a letter and contain only letters, numbers, ".", "-", "\_", ":", "/", and single spaces.

### A.1.4 XML Schema Target Package Naming

The **Target Package Name** that you specify for an XMLFact on the XML Schema Selector page is limited to ASCII characters, digits, and the underscore character.



# B

---

---

## Oracle Business Rules Built-in Classes and Functions

This appendix discusses the extensive library of Oracle Business Rules (OBR) built-in classes, methods, and functions that help reasoning about data containing text strings, lists, numbers, dates, times, and so on.

In the following sections, there are multiple tables whose each row has a Kind column that is either **Cl**, **Co**, **M**, **sM**, **P**, or **sP** (Class, Constructor, Method, static Method, Property, or static Property (Java static final field) respectively). The first row in each table specifies the class. When the Java Name is the same as the OBR Name (the rule SDK terms it the Alias), a '-' is displayed. The Signature column provides type information for methods, functions, and properties. The signature of a property is actually the type, for example `BigDecimal`. The signature of a method or function is of the form `return (arg1, arg2, ...)`, where `return` is the return type and `arg1, arg2, ...` are the argument types.

This appendix covers the following sections:

- [Section B.1, "String Classes"](#)
- [Section B.2, "List Classes"](#)
- [Section B.3, "Numeric Classes"](#)
- [Section B.4, "Time and Duration Classes"](#)
- [Section B.5, "Miscellaneous Classes"](#)
- [Section B.6, "Functions"](#)

### B.1 String Classes

This section covers the String-related classes provided by Oracle Business Rules.

[Table B-1](#) lists the String class.

**Table B-1** Lists the String Class

OBR Name	Kind	Signature	Java Name	Description	Reference
String	Cl	-	java.lang.String	Java immutable character strings. Beware, Java uses 0-based indexing for characters in strings, and XML uses 1-based indexing	<a href="http://java.sun.com/javase/6/docs/api/java/lang/String.html">http://java.sun.com/javase/6/docs/api/java/lang/String.html</a>
charAt	S	char(int)	-	Returns the char value at 0-based index arg1. "Oracle".charAt(2)=='a'	<a href="http://java.sun.com/javase/6/docs/api/java/lang/String.html#charAt%28int%29">http://java.sun.com/javase/6/docs/api/java/lang/String.html#charAt%28int%29</a>

**Table B-1 (Cont.) Lists the String Class**

OBR Name	Kind	Signature	Java Name	Description	Reference
compareTo	M	int(String)	-	Returns the value 0 if the argument string is equal to this string; a value less than 0 if this string is lexicographically less than the string argument; and a value greater than 0 if this string is lexicographically greater than the string argument. "a".compareTo("b")<0.	<a href="http://java.sun.com/javase/6/docs/api/java/lang/String.html#compareTo%28java.lang.String%29">http://java.sun.com/javase/6/docs/api/java/lang/String.html#compareTo%28java.lang.String%29</a>
contains	M	boolean(String)	-	Tests whether this string contains arg1. "Oracle".contains("rac")==true.	<a href="http://java.sun.com/javase/6/docs/api/java/lang/String.html#contains%28java.lang.CharSequence%29">http://java.sun.com/javase/6/docs/api/java/lang/String.html#contains%28java.lang.CharSequence%29</a>
endsWith	M	boolean(String)	-	Tests whether this string ends with arg1. "Oracle".endsWith("le")==true.	<a href="http://java.sun.com/javase/6/docs/api/java/lang/String.html#endsWith%28java.lang.String%29">http://java.sun.com/javase/6/docs/api/java/lang/String.html#endsWith%28java.lang.String%29</a>
equalsIgnoreCase	M	boolean(String)	-	Tests whether this string equals arg1, ignoring case consideration. "Oracle".equalsIgnoreCase("oRaClE")==true.	<a href="http://java.sun.com/javase/6/docs/api/java/lang/String.html#equalsIgnoreCase%28java.lang.String%29">http://java.sun.com/javase/6/docs/api/java/lang/String.html#equalsIgnoreCase%28java.lang.String%29</a>
indexOf	M	int(String,int)	-	Returns the 0-based index of the start of arg1 within this String, but not before the 0-based index arg2. "banana".indexOf("an",2)==3.	<a href="http://java.sun.com/javase/6/docs/api/java/lang/String.html#indexOf%28java.lang.String,%20int%29">http://java.sun.com/javase/6/docs/api/java/lang/String.html#indexOf%28java.lang.String,%20int%29</a>
lastIndexOf	M	int(String,int)	-	Returns the 0-based index within this string of the last occurrence of arg1, searching backward starting at the index arg2. "banana".lastIndexOf("an","banana".length())==3.	<a href="http://java.sun.com/javase/6/docs/api/java/lang/String.html#lastIndexOf%28java.lang.String,%20int%29">http://java.sun.com/javase/6/docs/api/java/lang/String.html#lastIndexOf%28java.lang.String,%20int%29</a>
length	M	int	-	Returns the length of this string. "Oracle".length()==6.	<a href="http://java.sun.com/javase/6/docs/api/java/lang/String.html#length%28%29">http://java.sun.com/javase/6/docs/api/java/lang/String.html#length%28%29</a>
matches	M	boolean(String)	-	Tests if this string matches the given regular expression. "banana".matches("^b.*a\$")==true.	<a href="http://java.sun.com/javase/6/docs/api/java/lang/String.html#matches%28java.lang.String%29">http://java.sun.com/javase/6/docs/api/java/lang/String.html#matches%28java.lang.String%29</a>
replaceAll	M	String(String,String)	-	Replaces each substring of this string that matches arg1 (a regular expression) with arg2. "banana".replaceAll("a","xo")== "xoxoxo".	<a href="http://java.sun.com/javase/6/docs/api/java/lang/String.html#replaceAll%28java.lang.String,%20java.lang.String%29">http://java.sun.com/javase/6/docs/api/java/lang/String.html#replaceAll%28java.lang.String,%20java.lang.String%29</a>
replaceFirst	M	String(String,String)	-	Replaces first substring of this string that matches arg1 (a regular expression) with arg2. "banana".replaceFirst("a","xo")== "xonana".	<a href="http://java.sun.com/javase/6/docs/api/java/lang/String.html#replaceFirst%28java.lang.String,%20java.lang.String%29">http://java.sun.com/javase/6/docs/api/java/lang/String.html#replaceFirst%28java.lang.String,%20java.lang.String%29</a>
startsWith	M	boolean(String)	-	Tests whether this string starts with arg1. "Oracle".startsWith("Or")==true.	<a href="http://java.sun.com/javase/6/docs/api/java/lang/String.html#startsWith%28java.lang.String%29">http://java.sun.com/javase/6/docs/api/java/lang/String.html#startsWith%28java.lang.String%29</a>
substring	M	String(int,int)	-	Returns the substring of this string, starting with the 0-based index arg1, and ending before the 0-based index arg2. "Oracle".substring(1,4)== "rac".	<a href="http://java.sun.com/javase/6/docs/api/java/lang/String.html#substring%28int,%20int%29">http://java.sun.com/javase/6/docs/api/java/lang/String.html#substring%28int,%20int%29</a>
toLowerCase	M	String()	-	Converts this string to lower case. "Oracle".toLowerCase()=="oracle".	<a href="http://java.sun.com/javase/6/docs/api/java/lang/String.html#toLowerCase%28%29">http://java.sun.com/javase/6/docs/api/java/lang/String.html#toLowerCase%28%29</a>



**Table B–1 (Cont.) Lists the String Class**

OBR Name	Kind	Signature	Java Name	Description	Reference
toUpperCase	M	String()	-	Converts this string to upper case. "Oracle".toUpperCase()=="ORACLE".	<a href="http://java.sun.com/java/6/docs/api/java/lang/String.html#toUpperCase%28%29">http://java.sun.com/java/6/docs/api/java/lang/String.html#toUpperCase%28%29</a>
trim	M	String()	-	Removes leading and trailing whitespace. " Oracle ".trim()=="Oracle".	<a href="http://java.sun.com/java/6/docs/api/java/lang/String.html#trim%28%29">http://java.sun.com/java/6/docs/api/java/lang/String.html#trim%28%29</a>

Table B–2 lists the RL class strings methods.

**Table B–2 Lists the RL Class String Method**

OBR Name	Kind	Signature	Java Name	Description	Reference
RL	CI	-	oracle.rules.rl.extensions.RL	Supplement standard Java classes with W3C RIF functionality.	<a href="http://www.w3.org/TR/rif-dtb/">http://www.w3.org/TR/rif-dtb/</a>
string.join	sM	String(String...)	stringJoin	Concatenates first n-1 args using the last arg as a separator. RL.string.join("a","b","c","#")=="a#b#c".	<a href="http://www.w3.org/TR/rif-dtb/#func:string-join">http://www.w3.org/TR/rif-dtb/#func:string-join</a>
string.substring	sM	String(String,int,int)	substring	Returns the substring of arg1, beginning at the 1-based index arg2, and continuing for arg3 characters. RL.string.substring("Oracle",2,3]=="rac".	<a href="http://www.w3.org/TR/rif-dtb/#func:substring">http://www.w3.org/TR/rif-dtb/#func:substring</a>
string.suffix	sM	String(String,int)	substring	Returns the suffix of arg1, beginning at the 1-based index arg2. RL.string.suffix("Oracle",5]=="le".	<a href="http://www.w3.org/TR/rif-dtb/#func:substring">http://www.w3.org/TR/rif-dtb/#func:substring</a>
string.substring before	sM	String(String,String)	substringBefore	Returns the substring of arg1 that occurs before arg2. RL.string.substring before("Oracle","ac")=="Or".	<a href="http://www.w3.org/TR/rif-dtb/#func:substring-before">http://www.w3.org/TR/rif-dtb/#func:substring-before</a>
string.substring after	sM	String(String,String)	substringAfter	Returns the substring of arg1 that occurs after arg2. RL.string.substring after("Oracle","ac")=="le".	<a href="http://www.w3.org/TR/rif-dtb/#func:substring-after">http://www.w3.org/TR/rif-dtb/#func:substring-after</a>
string.iri.encode path	sM	String(String)	encodeForURI	Encodes characters not permitted in a URI path. RL.string.iri encode path("Oracle Business Rules")=="Oracle%20Business%20Rules".	<a href="http://www.w3.org/TR/rif-dtb/#func:encode-for-uri">http://www.w3.org/TR/rif-dtb/#func:encode-for-uri</a>
string.iri.to uri	sM	String(String)	iriToUri	Encodes some characters not permitted in a URI. RL.string.iri to uri("http://www.example.com/~bébé")=="http://www.example.com/~b%C3%A9b%C3%A9".	<a href="http://www.w3.org/TR/rif-dtb/#func:iri-to-uri">http://www.w3.org/TR/rif-dtb/#func:iri-to-uri</a>
string.iri.to ascii	sM	String(String)	escapeHtmlUri	Encodes non-ascii characters. RL.string.iri to ascii("javascript:if (navigator.browserLanguage == 'fr') window.open('http://www.example.com/~bébé');")=="javascript:if (navigator.browserLanguage == 'fr') window.open('http://www.example.com/~b%C3%A9b%C3%A9');"	<a href="http://www.w3.org/TR/rif-dtb/#func:escape-html-uri">http://www.w3.org/TR/rif-dtb/#func:escape-html-uri</a>
string.is normalized	sM	boolean(String)	isNormalizedString	A normalized string does not contain the carriage return (#xD), line feed (#xA) nor tab (#x9) characters. RL.string.is normalized(" Business Rules ")==true.	<a href="http://www.w3.org/TR/rif-dtb/#Guard_Predicates_for_Datatypes">http://www.w3.org/TR/rif-dtb/#Guard_Predicates_for_Datatypes</a>

**Table B–2 (Cont.) Lists the RL Class String Method**

OBR Name	Kind	Signature	Java Name	Description	Reference
string.is token	sM	boolean(String)	isToken	A token is a normalized string with no leading or trailing spaces, and no double spaces. RL.string.is token("Business Rules")==true.	<a href="http://www.w3.org/TR/rif-dtb/#Guard_Predicates_for_Datatypes">http://www.w3.org/TR/rif-dtb/#Guard_Predicates_for_Datatypes</a>
string.is language	sM	boolean(String)	isLanguage	A language identifier. RL.string.is language("en")==true.	<a href="http://www.w3.org/TR/rif-dtb/#Guard_Predicates_for_Datatypes">http://www.w3.org/TR/rif-dtb/#Guard_Predicates_for_Datatypes</a>
string.is Name	sM	boolean(String)	isName	A name is a token with no spaces (and some other constraints on its characters). RL.string.is Name("xs:Name")==true.	<a href="http://www.w3.org/TR/rif-dtb/#Guard_Predicates_for_Datatypes">http://www.w3.org/TR/rif-dtb/#Guard_Predicates_for_Datatypes</a>
string.is NCName	sM	boolean(String)	isNCName	A non-colonized name. RL.string.is NCName("xs:NCName")==false.	<a href="http://www.w3.org/TR/rif-dtb/#Guard_Predicates_for_Datatypes">http://www.w3.org/TR/rif-dtb/#Guard_Predicates_for_Datatypes</a>
string.is NMTOKEN	sM	boolean(String)	isNMTOKEN	An NMTOKEN is a Name with no restriction on the initial character. RL.string.is NMTOKEN("-Oracle")==true.	<a href="http://www.w3.org/TR/rif-dtb/#Guard_Predicates_for_Datatypes">http://www.w3.org/TR/rif-dtb/#Guard_Predicates_for_Datatypes</a>
string.compare	sM	int(String,String)	compare	Returns -1, 0, or 1 if arg1<arg2, arg1==arg2, or arg1>arg2, respectively. RL.string.compare("foo","bar")==1.	<a href="http://www.w3.org/TR/rif-dtb/#func:compare_28adapted_from_fn:compare.29">http://www.w3.org/TR/rif-dtb/#func:compare_28adapted_from_fn:compare.29</a>

## B.2 List Classes

This section covers the List classes provided by Oracle Business Rules.

Table B–3 lists the List class.

**Table B–3 Lists the List class**

OBR Name	Kind	Signature	Java Name	Description	Reference
List	Cl	-	java.util.List	<b>Represents mutable and immutable lists. Lists use 0-based indexes. Attempts to modify an immutable list may result in UnsupportedOperationExceptions.</b>	<a href="http://java.sun.com/javase/6/docs/api/java/util/List.html">http://java.sun.com/javase/6/docs/api/java/util/List.html</a>
append	M	void(Object)	add	Appends arg1 to this list. Modifies this list.	<a href="http://java.sun.com/javase/6/docs/api/java/util/List.html#add(E)">http://java.sun.com/javase/6/docs/api/java/util/List.html#add(E)</a>
add	M	void(int,Object)	-	Inserts arg2 into this list at position arg1. Modifies this list.	<a href="http://java.sun.com/javase/6/docs/api/java/util/List.html#add(int,%20E)">http://java.sun.com/javase/6/docs/api/java/util/List.html#add(int,%20E)</a>
appendAll	M	void(java.util.Collection)	addAll	Appends the contents of arg1 to this list. Modifies this list.	<a href="http://java.sun.com/javase/6/docs/api/java/util/List.html#addAll(java.util.Collection)">http://java.sun.com/javase/6/docs/api/java/util/List.html#addAll(java.util.Collection)</a>

**Table B-3 (Cont.) Lists the List class**

OBR Name	Kind	Signature	Java Name	Description	Reference
addAll	M	void(int,java.util.Collection)	-	Inserts the contents of arg2 into this list at position arg1. Modifies this list.	<a href="http://java.sun.com/javase/6/docs/api/java/util/List.html#addAll(int,%20java.util.Collection)">http://java.sun.com/javase/6/docs/api/java/util/List.html#addAll(int,%20java.util.Collection)</a>
clear	M	void()	-	Removes the contents of this list. Modifies this list.	<a href="http://java.sun.com/javase/6/docs/api/java/util/List.html#clear()">http://java.sun.com/javase/6/docs/api/java/util/List.html#clear()</a>
contains	M	boolean(Object)	-	Tests whether this list contains arg1. RL.list.create(1,2,3).contains(2)==true.	<a href="http://java.sun.com/javase/6/docs/api/java/util/List.html#contains(java.lang.Object)">http://java.sun.com/javase/6/docs/api/java/util/List.html#contains(java.lang.Object)</a>
containsAll	M	boolean(java.util.Collection)	-	Tests whether this list contains every element in arg1. RL.list.create(1,2,3).containsAll(RL.list.create(3,2,1))==true.	<a href="http://java.sun.com/javase/6/docs/api/java/util/List.html#containsAll(java.util.Collection)">http://java.sun.com/javase/6/docs/api/java/util/List.html#containsAll(java.util.Collection)</a>
get	M	Object(int)	-	Get the element at position arg1. RL.list.create(1,2,3).get(1)==2.	<a href="http://java.sun.com/javase/6/docs/api/java/util/List.html#get(int)">http://java.sun.com/javase/6/docs/api/java/util/List.html#get(int)</a>
indexOf	M	int(Object)	-	Returns first index of arg1 in this list. RL.list.create(1,2,3).indexOf(2)==1.	<a href="http://java.sun.com/javase/6/docs/api/java/util/List.html#indexOf(java.lang.Object)">http://java.sun.com/javase/6/docs/api/java/util/List.html#indexOf(java.lang.Object)</a>
remove	M	boolean(Object)	-	Removes first occurrence of arg1 from this list. Returns whether this list was modified.	<a href="http://java.sun.com/javase/6/docs/api/java/util/List.html#remove(java.lang.Object)">http://java.sun.com/javase/6/docs/api/java/util/List.html#remove(java.lang.Object)</a>
remove by index	M	Object(int)	remove	Removes and return the element at position arg1. Modifies this list.	<a href="http://java.sun.com/javase/6/docs/api/java/util/List.html#remove(int)">http://java.sun.com/javase/6/docs/api/java/util/List.html#remove(int)</a>
removeAll	M	boolean(java.util.Collection)	-	Removes all elements from this list that are contained in arg1. Returns whether this list was modified.	<a href="http://java.sun.com/javase/6/docs/api/java/util/List.html#removeAll(java.util.Collection)">http://java.sun.com/javase/6/docs/api/java/util/List.html#removeAll(java.util.Collection)</a>
retainAll	M	boolean(java.util.Collection)	-	Removes all elements from this list that are *not* contained in arg1. Returns whether this list was modified.	<a href="http://java.sun.com/javase/6/docs/api/java/util/List.html#retainAll(java.util.Collection)">http://java.sun.com/javase/6/docs/api/java/util/List.html#retainAll(java.util.Collection)</a>

**Table B–3 (Cont.) Lists the List class**

OBR Name	Kind	Signature	Java Name	Description	Reference
set	M	Object(int,Object)	-	Replaces the item in this list at position arg1 with arg2. Returns the replaced item. Modifies this list.	<a href="http://java.sun.com/javase/6/docs/api/java/util/List.html#set(int,%20E)">http://java.sun.com/javase/6/docs/api/java/util/List.html#set(int,%20E)</a>
size	M	int()	-	Returns the size of this list. RL.list.create(1,2,3).size()==3.	<a href="http://java.sun.com/javase/6/docs/api/java/util/List.html#size()">http://java.sun.com/javase/6/docs/api/java/util/List.html#size()</a>
subList	M	List(int,int)	-	Returns a view of the portion of this list between arg1, inclusive, and arg2, exclusive. RL.list.create(1,2,3,4).subList(1,3)==RL.list.create(2,3).	<a href="http://java.sun.com/javase/6/docs/api/java/util/List.html#subList(int,%20int)">http://java.sun.com/javase/6/docs/api/java/util/List.html#subList(int,%20int)</a>

Table B–4 lists the RL class list methods.

**Table B–4 Lists the RL Class List Method**

OBR Name	Kind	Signature	Java Name	Description	Reference
RL	CI	-	oracle.rules.rl.extensions.RL	-	-
list.append	sM	List(List, Object...)	append	Returns a new immutable list containing the contents of arg1, followed by arg2, arg3, ... RL.list.append(RL.list.create(1),2,3)==RL.list.create(1,2,3).	<a href="http://www.w3.org/TR/rif-dtb/#func:append">http://www.w3.org/TR/rif-dtb/#func:append</a>
list.concatenate	sM	List(List...)	concatenate	Returns a new immutable list containing the concatenation of arg1, arg2, ... RL.list.concatenate(RL.list.create(1),RL.list.create(2))==RL.list.create(1,2).	<a href="http://www.w3.org/TR/rif-dtb/#func:concatenate">http://www.w3.org/TR/rif-dtb/#func:concatenate</a>
list.distinct values	sM	List(List)	distinctValues	Returns a new immutable list like arg1 but with duplicates removed. RL.list.distinctValues(RL.list.create(2,2))==RL.list.create(2).	<a href="http://www.w3.org/TR/rif-dtb/#func:distinct-values">http://www.w3.org/TR/rif-dtb/#func:distinct-values</a>
list.except	sM	List(List,List)	except	Returns a new immutable list containing elements from arg1 that are not in arg2. RL.list.except(RL.list.create(1,2,3,4),RL.list.create(1,3))==RL.list.create(2,4).	<a href="http://www.w3.org/TR/rif-dtb/#func:except">http://www.w3.org/TR/rif-dtb/#func:except</a>
list.get	sM	Object(List,int)	get	Returns the element at position arg2 in arg1. If arg2<0, return the element at arg1.size()+arg2. RL.list.get(RL.list.create(1,2,3),-1)==3.	<a href="http://www.w3.org/TR/rif-dtb/#func:get">http://www.w3.org/TR/rif-dtb/#func:get</a>
list.index of	sM	List<Integer>(List, Object)	indexOf	Returns a list of indexes where the arg2 occurs in arg1. RL.list.indexof(RL.list.create(1,2,3,2),2)==RL.list.create(1,3).	<a href="http://www.w3.org/TR/rif-dtb/#func:index-of">http://www.w3.org/TR/rif-dtb/#func:index-of</a>

**Table B-4 (Cont.) Lists the RL Class List Method**

OBR Name	Kind	Signature	Java Name	Description	Reference
list.insert before	sM	List(List,int,Obje ct)	insertBefore	Returns a new immutable list containing arg1 with arg3 inserted before the item at position arg2. If arg2<0, arg3 is inserted before the element at arg1.size()+arg2. RL.list.insert before(RL.list.create(1,2,3),-1,99)==RL.list.create(1,2,99,3).	<a href="http://www.w3.org/TR/rif-dtb/#func:insert-before">http://www.w3.org/TR/rif-dtb/#func:insert-before</a>
list.intersect	sM	List(List,List)	intersect	Returns a new immutable list containing the intersection of arg1 and arg2. RL.list.intersect(RL.list.create(1,2,3),RL.list.create(3,1))==RL.list.create(1,3).	<a href="http://www.w3.org/TR/rif-dtb/#func:intersect">http://www.w3.org/TR/rif-dtb/#func:intersect</a>
list.create	sM	List(Object...)	list	Returns a new immutable list containing the arguments.	<a href="http://www.w3.org/TR/rif-dtb/#func:make-list">http://www.w3.org/TR/rif-dtb/#func:make-list</a>
list.remove	sM	List(List,int)	remove	Returns a new immutable list containing the elements of arg1, with the element at position arg2 removed. If arg2<0, the element at arg1.size()+arg2 is removed. RL.list.remove(RL.list.create(1,2,3),0)==RL.list.create(2,3).	<a href="http://www.w3.org/TR/rif-dtb/#func:remove">http://www.w3.org/TR/rif-dtb/#func:remove</a>
list.reverse	sM	List(List)	reverse	Returns a new immutable list containing the elements of arg1 in reverse order. RL.list.reverse(RL.list.create(1,2,3))==RL.list.create(3,2,1).	<a href="http://www.w3.org/TR/rif-dtb/#func:reverse">http://www.w3.org/TR/rif-dtb/#func:reverse</a>
list.union	sM	List(List)	union	Returns a new immutable list containing the concatenation of the arguments with duplicates removed. RL.list.union(RL.list.create(1,2),RL.list.create(2,3))==RL.list.create(1,2,3).	<a href="http://www.w3.org/TR/rif-dtb/#func:union">http://www.w3.org/TR/rif-dtb/#func:union</a>

### B.3 Numeric Classes

Oracle Business Rules support the primitive Java numeric types byte, short, int, long, float, and double. OBR also supports the "boxed" versions: Short, Int, Long, Float, and Double. Unlimited precision integers and decimals are supported, using the Java classes BigInteger and BigDecimal. OBR supports arithmetic expressions (+, -, \*, /, \*\*) on all numeric types. For example, if \*bd is BigDecimal, then you can add one to it by simply writing bd + 1. You do not have to write bd.add(BigDecimal.ONE).

Table B-5 lists the Integer class.

**Table B-5 Lists the Integer Class**

OBR Name	Kind	Signature	Java Name	Description	Reference
Integer	Cl	-	java.lang.Integer	An integer object. Unlike the primitive "int", an Integer can be null and can be in Lists.	<a href="http://java.sun.com/javase/6/docs/api/java/lang/Integer.html">http://java.sun.com/javase/6/docs/api/java/lang/Integer.html</a>
Integer	Co	Integer(int String)	-	Creates an Integer from an int or from its lexical representation as a String, new Integer(1)==new Integer("1").	<a href="http://java.sun.com/javase/6/docs/api/java/lang/Integer.html#Integer(int)">http://java.sun.com/javase/6/docs/api/java/lang/Integer.html#Integer(int)</a>
MIN_VALUE	sP	int	-	Smallest primitive int value. Integer.MIN_VALUE<0.	<a href="http://java.sun.com/javase/6/docs/api/java/lang/Integer.html#MIN_VALUE">http://java.sun.com/javase/6/docs/api/java/lang/Integer.html#MIN_VALUE</a>

**Table B–5 (Cont.) Lists the Integer Class**

OBR Name	Kind	Signature	Java Name	Description	Reference
MAX_VALUE	sP	int	-	Largest primitive int value. Integer.MAX_VALUE>0.	<a href="http://java.sun.com/javase/6/docs/api/java/lang/Integer.html#MAX_VALUE">http://java.sun.com/javase/6/docs/api/java/lang/Integer.html#MAX_VALUE</a>
intValue	M	int()	-	Converts this Integer to an int. new Integer(1).intValue()==1.	<a href="http://java.sun.com/javase/6/docs/api/java/lang/Integer.html#intValue()">http://java.sun.com/javase/6/docs/api/java/lang/Integer.html#intValue()</a>
toString	M	String()	-	Converts this Integer to its lexical representation. new Integer(1).toString()=="1".	<a href="http://java.sun.com/javase/6/docs/api/java/lang/Integer.html#toString()">http://java.sun.com/javase/6/docs/api/java/lang/Integer.html#toString()</a>

Table B–6 lists the Long class.

**Table B–6 Lists the Long Class**

OBR Name	Kind	Signature	Java Name	Description	Reference
Long	Cl	-	java.lang.Long	A long integer object. Unlike the primitive "long", a Long can be null and can be in Lists.	<a href="http://java.sun.com/javase/6/docs/api/java/lang/Long.html">http://java.sun.com/javase/6/docs/api/java/lang/Long.html</a>
Long	Co	Long(long String)	-	Creates a Long from a long or from its lexical representation as a String. new Long(1)==new Long("1").	<a href="http://java.sun.com/javase/6/docs/api/java/lang/Long.html#Long(long)">http://java.sun.com/javase/6/docs/api/java/lang/Long.html#Long(long)</a>
MIN_VALUE	sP	long	-	Smallest primitive long value. Long.MIN_VALUE<0.	<a href="http://java.sun.com/javase/6/docs/api/java/lang/Long.html#MIN_VALUE">http://java.sun.com/javase/6/docs/api/java/lang/Long.html#MIN_VALUE</a>
MAX_VALUE	sP	long	-	Largest primitive long value. Long.MAX_VALUE>0.	<a href="http://java.sun.com/javase/6/docs/api/java/lang/Long.html#MAX_VALUE">http://java.sun.com/javase/6/docs/api/java/lang/Long.html#MAX_VALUE</a>
longValue	M	long()	-	Converts this Long to a long. new Long(1).longValue()==1.	<a href="http://java.sun.com/javase/6/docs/api/java/lang/Long.html#longValue()">http://java.sun.com/javase/6/docs/api/java/lang/Long.html#longValue()</a>
toString	M	String()	-	Converts this Long to its lexical representation. new Long(1).toString()=="1".	<a href="http://java.sun.com/javase/6/docs/api/java/lang/Long.html#toString()">http://java.sun.com/javase/6/docs/api/java/lang/Long.html#toString()</a>

Table B–7 lists the Short class.

**Table B–7 Lists the Short Class**

OBR Name	Kind	Signature	Java Name	Description	Reference
Short	Cl	-	java.lang.Short	A short integer object. Unlike the primitive "short", a Short can be null and can be in Lists.	<a href="http://java.sun.com/javase/6/docs/api/java/lang/Short.html">http://java.sun.com/javase/6/docs/api/java/lang/Short.html</a>
Short	Co	Short(short String)	-	Creates a Short from a short or from its lexical representation as a String. new Short(1)==new Short("1").	<a href="http://java.sun.com/javase/6/docs/api/java/lang/Short.html#Short(short)">http://java.sun.com/javase/6/docs/api/java/lang/Short.html#Short(short)</a>
MIN_VALUE	sP	short	-	Smallest primitive short value. Short.MIN_VALUE<0.	<a href="http://java.sun.com/javase/6/docs/api/java/lang/Short.html#MIN_VALUE">http://java.sun.com/javase/6/docs/api/java/lang/Short.html#MIN_VALUE</a>
MAX_VALUE	sP	short	-	Largest primitive short value. Short.MAX_VALUE>0.	<a href="http://java.sun.com/javase/6/docs/api/java/lang/Short.html#MAX_VALUE">http://java.sun.com/javase/6/docs/api/java/lang/Short.html#MAX_VALUE</a>

**Table B-7 (Cont.) Lists the Short Class**

OBR Name	Kind	Signature	Java Name	Description	Reference
shortValue	M	short()	-	Converts this Short to a short. new Short(-1).shortValue()=-1.	<a href="http://java.sun.com/javase/6/docs/api/java/lang/Short.html#shortValue()">http://java.sun.com/javase/6/docs/api/java/lang/Short.html#shortValue()</a>
toString	M	String()	-	Converts this Short to its lexical representation. new Short(-1).toString()=-1.	<a href="http://java.sun.com/javase/6/docs/api/java/lang/Short.html#toString()">http://java.sun.com/javase/6/docs/api/java/lang/Short.html#toString()</a>

Table B-8 lists the Float class.

**Table B-8 Lists the Float Class**

OBR Name	Kind	Signature	Java Name	Description	Reference
Float	Cl	-	java.lang.Float	<b>A Float object. Unlike the primitive "float", a Float can be null and can be in Lists.</b>	<a href="http://java.sun.com/javase/6/docs/api/java/lang/Float.html">http://java.sun.com/javase/6/docs/api/java/lang/Float.html</a>
Float	Co	Float(float   double   String)	-	Creates a Float from a float, a double, or from its lexical representation as a String. new Float(1.1)==new Float("1.1").	<a href="http://java.sun.com/javase/6/docs/api/java/lang/Float.html#Float(float)">http://java.sun.com/javase/6/docs/api/java/lang/Float.html#Float(float)</a>
infinite	P	boolean	-	The value of this Float is infinity. new Float(Float.NEGATIVE_INFINITY).infinite==true.	<a href="http://java.sun.com/javase/6/docs/api/java/lang/Float.html#isInfinite()">http://java.sun.com/javase/6/docs/api/java/lang/Float.html#isInfinite()</a>
NaN	P	boolean	-	The value of this Float is not a number. new Float(Float.NaN).NaN==true.	<a href="http://java.sun.com/javase/6/docs/api/java/lang/Float.html#isNaN()">http://java.sun.com/javase/6/docs/api/java/lang/Float.html#isNaN()</a>
NaN	sP	float	-	Value representing "not a number".	<a href="http://java.sun.com/javase/6/docs/api/java/lang/Float.html#NaN">http://java.sun.com/javase/6/docs/api/java/lang/Float.html#NaN</a>
NEGATIVE_INFINITY	sP	float	-	Value representing negative infinity.	<a href="http://java.sun.com/javase/6/docs/api/java/lang/Float.html#NEGATIVE_INFINITY">http://java.sun.com/javase/6/docs/api/java/lang/Float.html#NEGATIVE_INFINITY</a>
POSITIVE_INFINITY	sP	float	-	Value representing positive infinity.	<a href="http://java.sun.com/javase/6/docs/api/java/lang/Float.html#POSITIVE_INFINITY">http://java.sun.com/javase/6/docs/api/java/lang/Float.html#POSITIVE_INFINITY</a>
floatValue	M	float()	-	Converts this Float to a float. new Float(1.1f).floatValue()==1.1f.	<a href="http://java.sun.com/javase/6/docs/api/java/lang/Float.html#floatValue()">http://java.sun.com/javase/6/docs/api/java/lang/Float.html#floatValue()</a>
toString	M	String()	-	Converts this Float to its lexical representation. new Float(1.1f).toString()=="1.1".	<a href="http://java.sun.com/javase/6/docs/api/java/lang/Float.html#toString()">http://java.sun.com/javase/6/docs/api/java/lang/Float.html#toString()</a>

Table B-9 lists the Double class.

**Table B-9 Lists the Double Class**

OBR Name	Kind	Signature	Java Name	Description	Reference
Double	Cl	-	java.lang.Double	<b>A Double object. Unlike the primitive "double", a Double can be null and can be in Lists.</b>	<a href="http://java.sun.com/javase/6/docs/api/java/lang/Double.html">http://java.sun.com/javase/6/docs/api/java/lang/Double.html</a>
Double	Co	Double(double   String)	-	Creates a Double from a double or from its lexical representation as a String. new Double(1.1)==new Double("1.1").	<a href="http://java.sun.com/javase/6/docs/api/java/lang/Double.html#Double(double)">http://java.sun.com/javase/6/docs/api/java/lang/Double.html#Double(double)</a>

**Table B–9 (Cont.) Lists the Double Class**

OBR Name	Kind	Signature	Java Name	Description	Reference
infinite	P	boolean	-	The value of this Double is infinity. new Float(Float.POSITIVE_INFINITY).infinite==true.	<a href="http://java.sun.com/javase/6/docs/api/java/lang/Double.html#isInfinite()">http://java.sun.com/javase/6/docs/api/java/lang/Double.html#isInfinite()</a>
NaN	P	boolean	-	The value of this Double is not a number. new Double(double.NaN).NaN==true.	<a href="http://java.sun.com/javase/6/docs/api/java/lang/Double.html#isNaN()">http://java.sun.com/javase/6/docs/api/java/lang/Double.html#isNaN()</a>
NaN	sP	double	-	Value representing "not a number".	<a href="http://java.sun.com/javase/6/docs/api/java/lang/Double.html#NaN">http://java.sun.com/javase/6/docs/api/java/lang/Double.html#NaN</a>
NEGATIVE_INFINITY	sP	double	-	Value representing negative infinity.	<a href="http://java.sun.com/javase/6/docs/api/java/lang/Double.html#NEGATIVE_INFINITY">http://java.sun.com/javase/6/docs/api/java/lang/Double.html#NEGATIVE_INFINITY</a>
POSITIVE_INFINITY	sP	double	-	Value representing positive infinity.	<a href="http://java.sun.com/javase/6/docs/api/java/lang/Double.html#POSITIVE_INFINITY">http://java.sun.com/javase/6/docs/api/java/lang/Double.html#POSITIVE_INFINITY</a>
doubleValue	M	double()	-	Converts this Double to a double. new Double(1.1).doubleValue()==1.1.	<a href="http://java.sun.com/javase/6/docs/api/java/lang/Double.html#doubleValue()">http://java.sun.com/javase/6/docs/api/java/lang/Double.html#doubleValue()</a>
toString	M	String()	-	Converts this Double to its lexical representation. new Double(1.1).toString()=="1.1".	<a href="http://java.sun.com/javase/6/docs/api/java/lang/Double.html#toString()">http://java.sun.com/javase/6/docs/api/java/lang/Double.html#toString()</a>

Table B–10 lists the BigInteger class.

**Table B–10 Lists the BigInteger Class**

OBR Name	Kind	Signature	Java Name	Description	Reference
BigInteger	Cl	-	java.math.BigInteger	Immutable arbitrary-precision integers.	<a href="http://java.sun.com/javase/6/docs/api/java/math/BigInteger.html">http://java.sun.com/javase/6/docs/api/java/math/BigInteger.html</a>
BigInteger	Co	BigInteger(String)	-	Creates a BigInteger from its lexical representation as a String. new BigInteger("1")==1.	<a href="http://java.sun.com/javase/6/docs/api/java/math/BigInteger.html#BigInteger(java.lang.String)">http://java.sun.com/javase/6/docs/api/java/math/BigInteger.html#BigInteger(java.lang.String)</a>
doubleValue	M	double()	-	Converts this BigInteger to a double. May lose precision. new BigInteger("1").doubleValue()==1.0.	<a href="http://java.sun.com/javase/6/docs/api/java/math/BigInteger.html#doubleValue()">http://java.sun.com/javase/6/docs/api/java/math/BigInteger.html#doubleValue()</a>
longValue	M	long()	-	Converts this BigInteger to a long. May lose precision. new BigInteger("1").longValue()==1L.	<a href="http://java.sun.com/javase/6/docs/api/java/math/BigInteger.html#longValue()">http://java.sun.com/javase/6/docs/api/java/math/BigInteger.html#longValue()</a>
max	M	BigInteger(BigInteger)	-	Returns the greater of this or arg1. new BigInteger("1").max(2)==2.	<a href="http://java.sun.com/javase/6/docs/api/java/math/BigInteger.html#max(java.math.BigInteger)">http://java.sun.com/javase/6/docs/api/java/math/BigInteger.html#max(java.math.BigInteger)</a>
min	M	BigInteger(BigInteger)	-	Returns the lesser of this or arg1. new BigInteger("1").min(2)==1.	<a href="http://java.sun.com/javase/6/docs/api/java/math/BigInteger.html#min(java.math.BigInteger)">http://java.sun.com/javase/6/docs/api/java/math/BigInteger.html#min(java.math.BigInteger)</a>
toString	M	String()	-	Returns the lexical representation of this BigInteger. new BigInteger("123").toString()=="123".	<a href="http://java.sun.com/javase/6/docs/api/java/math/BigInteger.html#toString()">http://java.sun.com/javase/6/docs/api/java/math/BigInteger.html#toString()</a>



**Table B–10 (Cont.) Lists the BigInteger Class**

OBR Name	Kind	Signature	Java Name	Description	Reference
valueOf	sM	BigInteger(long)	-	Converts arg1 (a long) to a BigInteger. <code>BigInteger.valueOf(123).toString()=="123"</code> .	<a href="http://java.sun.com/javase/6/docs/api/java/math/BigInteger.html#valueOf(long)">http://java.sun.com/javase/6/docs/api/java/math/BigInteger.html#valueOf(long)</a>

Table B–11 lists the BigDecimal class.

**Table B–11 Lists the BigDecimal Class**

OBR Name	Kind	Signature	Java Name	Description	Reference
BigDecimal	Cl	-	java.math.BigDecimal	Immutable, arbitrary-precision signed decimal numbers.	<a href="http://java.sun.com/javase/6/docs/api/java/math/BigDecimal.html">http://java.sun.com/javase/6/docs/api/java/math/BigDecimal.html</a>
BigDecimal	Co	BigDecimal(long double String)	-	Creates a BigDecimal from a long, a double, or from its lexical representation as a String. <code>new BigDecimal(1.1)==new BigDecimal("1.1")</code> .	<a href="http://java.sun.com/javase/6/docs/api/java/math/BigDecimal.html#BigDecimal(java.lang.String)">http://java.sun.com/javase/6/docs/api/java/math/BigDecimal.html#BigDecimal(java.lang.String)</a>
BigDecimal	Co	BigDecimal(BigInteger,int)	-	Creates a BigDecimal from BigInteger arg1 and scale arg2. <code>new BigDecimal(new BigInteger("123"),2)==1.23</code> .	<a href="http://java.sun.com/javase/6/docs/api/java/math/BigDecimal.html#BigDecimal(java.math.BigInteger,%20int)">http://java.sun.com/javase/6/docs/api/java/math/BigDecimal.html#BigDecimal(java.math.BigInteger,%20int)</a>
doubleValue	M	double()	-	Converts this BigDecimal to a double. May lose precision. <code>new BigDecimal("0.1").doubleValue()==0.1</code> .	<a href="http://java.sun.com/javase/6/docs/api/java/math/BigDecimal.html#doubleValue()">http://java.sun.com/javase/6/docs/api/java/math/BigDecimal.html#doubleValue()</a>
longValue	M	long()	-	Converts this BigDecimal to a long. May lose precision. <code>new BigDecimal("0.1").longValue()==0L</code> .	<a href="http://java.sun.com/javase/6/docs/api/java/math/BigDecimal.html#longValue()">http://java.sun.com/javase/6/docs/api/java/math/BigDecimal.html#longValue()</a>
max	M	BigDecimal(BigDecimal)	-	Returns the greater of this BigDecimal or arg1. <code>new BigDecimal("0.1").max(0.2)==0.2</code> .	<a href="http://java.sun.com/javase/6/docs/api/java/math/BigDecimal.html#max(java.math.BigDecimal)">http://java.sun.com/javase/6/docs/api/java/math/BigDecimal.html#max(java.math.BigDecimal)</a>
min	M	BigDecimal(BigDecimal)	-	Returns the lesser of this BigDecimal or arg1. <code>new BigDecimal("0.1").min(0.2)==0.1</code> .	<a href="http://java.sun.com/javase/6/docs/api/java/math/BigDecimal.html#min(java.math.BigDecimal)">http://java.sun.com/javase/6/docs/api/java/math/BigDecimal.html#min(java.math.BigDecimal)</a>
scale	M	int()	-	Returns the scale—the number of digits to the right of the decimal point. <code>new BigDecimal("1.00").scale()==2</code> .	<a href="http://java.sun.com/javase/6/docs/api/java/math/BigDecimal.html#scale()">http://java.sun.com/javase/6/docs/api/java/math/BigDecimal.html#scale()</a>
setScale	M	BigDecimal(int)	-	Sets the scale, but don't change the value. <code>new BigDecimal("1").setScale(2).toString()=="1.00"</code> .	<a href="http://java.sun.com/javase/6/docs/api/java/math/BigDecimal.html#setScale(int)">http://java.sun.com/javase/6/docs/api/java/math/BigDecimal.html#setScale(int)</a>
toEngineeringString	M	String()	-	Returns the literal representation of this BigDecimal using engineering notation if an exponent is needed. <code>new BigDecimal("123E2").toEngineeringString()=="12.3E+3"</code> .	<a href="http://java.sun.com/javase/6/docs/api/java/math/BigDecimal.html#toEngineeringString()">http://java.sun.com/javase/6/docs/api/java/math/BigDecimal.html#toEngineeringString()</a>

**Table B–11 (Cont.) Lists the BigDecimal Class**

OBR Name	Kind	Signature	Java Name	Description	Reference
toPlainString	M	String	-	Returns the literal representation of this BigDecimal without exponents. new BigDecimal("123E2").toPlainString()=="12300".	<a href="http://java.sun.com/javase/6/docs/api/java/math/BigDecimal.html#toPlainString()">http://java.sun.com/javase/6/docs/api/java/math/BigDecimal.html#toPlainString()</a>
valueOf	sM	BigDecimal(long   double)	-	Converts arg1 (a long or double) to a BigDecimal. new BigDecimal(1.3)==BigDecimal.valueOf(1.3).	<a href="http://java.sun.com/javase/6/docs/api/java/math/BigDecimal.html#valueOf(double)">http://java.sun.com/javase/6/docs/api/java/math/BigDecimal.html#valueOf(double)</a>
ROUND_UP	sP	int	-	Used with divide. new BigDecimal("11").divide(2, BigDecimal.ROUND_UP)==6.	<a href="http://java.sun.com/javase/6/docs/api/java/math/BigDecimal.html#ROUND_UP">http://java.sun.com/javase/6/docs/api/java/math/BigDecimal.html#ROUND_UP</a>
ROUND_DOWN	sP	int	-	Used with divide. new BigDecimal("11").divide(2, BigDecimal.ROUND_DOWN)==5.	<a href="http://java.sun.com/javase/6/docs/api/java/math/BigDecimal.html#ROUND_DOWN">http://java.sun.com/javase/6/docs/api/java/math/BigDecimal.html#ROUND_DOWN</a>
divide	M	BigDecimal(BigDecimal, int)	-	Returns this/arg1 with scale the same as this BigDecimal. If rounding must be performed to stay within the result scale, use the rounding mode given by arg2 (ROUND_UP or ROUND_DOWN). new BigDecimal("11").divide(2, BigDecimal.ROUND_UP)==6.	<a href="http://java.sun.com/javase/6/docs/api/java/math/BigDecimal.html#divide(java.math.BigDecimal,%20int)">http://java.sun.com/javase/6/docs/api/java/math/BigDecimal.html#divide(java.math.BigDecimal,%20int)</a>

Table B–12 lists the Number class.

**Table B–12 Lists the Number Class**

OBR Name	Kind	Signature	Java Name	Description	Reference
Number	Cl	-	-	Base class of all numerics (except primitives).	<a href="http://java.sun.com/javase/6/docs/api/java/lang/Number.html">http://java.sun.com/javase/6/docs/api/java/lang/Number.html</a>
doubleValue	M	double()	-	Converts this number to a double.	<a href="http://java.sun.com/javase/6/docs/api/java/lang/Float.html#doubleValue()">http://java.sun.com/javase/6/docs/api/java/lang/Float.html#doubleValue()</a>
floatValue	M	float()	-	Converts this number to a float.	<a href="http://java.sun.com/javase/6/docs/api/java/lang/Float.html#floatValue()">http://java.sun.com/javase/6/docs/api/java/lang/Float.html#floatValue()</a>
intValue	M	int()	-	Converts this number to a int.	<a href="http://java.sun.com/javase/6/docs/api/java/lang/Float.html#intValue()">http://java.sun.com/javase/6/docs/api/java/lang/Float.html#intValue()</a>
longValue	M	long()	-	Converts this number to a long.	<a href="http://java.sun.com/javase/6/docs/api/java/lang/Float.html#longValue()">http://java.sun.com/javase/6/docs/api/java/lang/Float.html#longValue()</a>
shortValue	M	short()	-	Converts this number to a short.	<a href="http://java.sun.com/javase/6/docs/api/java/lang/Float.html#shortValue()">http://java.sun.com/javase/6/docs/api/java/lang/Float.html#shortValue()</a>

Table B–13 lists the RL class number methods.

**Table B–13 Lists the RL Class Number Method**

OBR Name	Kind	Signature	Java Name	Description	Reference
RL	Cl	-	oracle.rules.rl.extensions.RL	-	-

**Table B–13 (Cont.) Lists the RL Class Number Method**

OBR Name	Kind	Signature	Java Name	Description	Reference
number.is byte	sM	boolean(Num ber)	isByte	arg1 is integral and -128<=arg1<=127. RL.numeric.is byte(200)==false.	<a href="http://www.w3.org/TR/rif-dt b/#Guard_Predicates_for_Datatypes">http://www.w3.org/TR/rif-dt b/#Guard_Predicates_for_Datatypes</a>
number.is short	sM	boolean(Num ber)	isShort	arg1 is integral and -32768<=arg1<=32767. RL.numeric.is short(0.1)==false.	<a href="http://www.w3.org/TR/rif-dt b/#Guard_Predicates_for_Datatypes">http://www.w3.org/TR/rif-dt b/#Guard_Predicates_for_Datatypes</a>
number.is int	sM	boolean(Num ber)	isInt	arg1 is integral and -2147483648<=arg1<=2147483647. RL.numeric.is int(-1000)==true.	<a href="http://www.w3.org/TR/rif-dt b/#Guard_Predicates_for_Datatypes">http://www.w3.org/TR/rif-dt b/#Guard_Predicates_for_Datatypes</a>
number.is long	sM	boolean(Num ber)	isLong	arg1 is integral and -9223372036854775808<=arg1<=9223372036854775807. RL.numeric.is integer(new BigInteger("100"))**100)==false.	<a href="http://www.w3.org/TR/rif-dt b/#Guard_Predicates_for_Datatypes">http://www.w3.org/TR/rif-dt b/#Guard_Predicates_for_Datatypes</a>
number.is integer	sM	boolean(Num ber)	isInteger	arg1 is integral. RL.numeric.is integer(new BigInteger("100"))**100)==true.	<a href="http://www.w3.org/TR/rif-dt b/#Guard_Predicates_for_Datatypes">http://www.w3.org/TR/rif-dt b/#Guard_Predicates_for_Datatypes</a>
number.is decimal	sM	boolean(Num ber)	isDecimal	arg1 is neither Double nor Float. RL.numeric.is decimal(1.1)==false.	<a href="http://www.w3.org/TR/rif-dt b/#Guard_Predicates_for_Datatypes">http://www.w3.org/TR/rif-dt b/#Guard_Predicates_for_Datatypes</a>
number.is non-negative integer	sM	boolean(Num ber)	isNonNegativeIn teger	arg1 is integral and arg1>=0. RL.numeric.is non-negative integer(-1)==false.	<a href="http://www.w3.org/TR/rif-dt b/#Guard_Predicates_for_Datatypes">http://www.w3.org/TR/rif-dt b/#Guard_Predicates_for_Datatypes</a>
number.is negative integer	sM	boolean(Num ber)	isNegativeInte ger	arg1 is integral and arg1<0. RL.numeric.is negative integer(-1)==true.	<a href="http://www.w3.org/TR/rif-dt b/#Guard_Predicates_for_Datatypes">http://www.w3.org/TR/rif-dt b/#Guard_Predicates_for_Datatypes</a>
number.is non-positive integer	sM	boolean(Num ber)	isNonPositiveInt eger	arg1 is integral and arg1<=0. RL.numeric.is non-positive integer(-1)==true.	<a href="http://www.w3.org/TR/rif-dt b/#Guard_Predicates_for_Datatypes">http://www.w3.org/TR/rif-dt b/#Guard_Predicates_for_Datatypes</a>
number.is positive integer	sM	boolean(Num ber)	isPositiveInteger	arg1 is integral and arg1>0. RL.numeric.is positive integer(-1)==false.	<a href="http://www.w3.org/TR/rif-dt b/#Guard_Predicates_for_Datatypes">http://www.w3.org/TR/rif-dt b/#Guard_Predicates_for_Datatypes</a>
number.is unsigned byte	sM	boolean(Num ber)	isUnsignedByte	arg1 is integral and 0<=arg1<=255. RL.numeric.is unsigned byte(200)==true.	<a href="http://www.w3.org/TR/rif-dt b/#Guard_Predicates_for_Datatypes">http://www.w3.org/TR/rif-dt b/#Guard_Predicates_for_Datatypes</a>
number.is unsigned short	sM	boolean(Num ber)	isUnsignedShort	arg1 is integral and 0<=arg1<=65535. RL.numeric.is unsigned short(0.1)==false.	<a href="http://www.w3.org/TR/rif-dt b/#Guard_Predicates_for_Datatypes">http://www.w3.org/TR/rif-dt b/#Guard_Predicates_for_Datatypes</a>
number.is unsigned int	sM	boolean(Num ber)	isUnsignedInt	arg1 is integral and 0<=arg1<=4294967295. RL.numeric.is unsigned int(-1000)==false.	<a href="http://www.w3.org/TR/rif-dt b/#Guard_Predicates_for_Datatypes">http://www.w3.org/TR/rif-dt b/#Guard_Predicates_for_Datatypes</a>
number.is unsigned long	sM	boolean(Num ber)	isUnsignedLong	arg1 is integral and 0<=arg1<=18446744073709551615.	<a href="http://www.w3.org/TR/rif-dt b/#Guard_Predicates_for_Datatypes">http://www.w3.org/TR/rif-dt b/#Guard_Predicates_for_Datatypes</a>

## B.4 Time and Duration Classes

This section lists the time and duration classes provided by Oracle Business Rules.

Table B–14 lists the Calendar class.

**Table B-14** Lists the Calendar Class

OBR Name	Kind	Signature	Java Name	Description	Reference
Calendar	CI	-	java.util.Calendar	A Calendar represents a datetime and timezone. A calendar instance has a number of mutable int fields. The first argument to add, get, isSet, roll, and set is a field number. This class provides a number of static properties that should be used for the field numbers.	<a href="http://java.sun.com/javase/6/docs/api/java/util/Calendar.html">http://java.sun.com/javase/6/docs/api/java/util/Calendar.html</a>
ERA	sP	int	-	Field number for the Calendar era. 1 is for A.D. and 0 is for B.C. ((Calendar)"2010-02-01").get(Calendar.ERA)==1.	<a href="http://java.sun.com/javase/6/docs/api/java/util/Calendar.html#ERA">http://java.sun.com/javase/6/docs/api/java/util/Calendar.html#ERA</a>
YEAR	sP	int	-	Field number for the Calendar year. ((Calendar)"2010-02-01").get(Calendar.YEAR)==2010.	<a href="http://java.sun.com/javase/6/docs/api/java/util/Calendar.html#YEAR">http://java.sun.com/javase/6/docs/api/java/util/Calendar.html#YEAR</a>
MONTH	sP	int	-	Field number for the Calendar month. Months are 0-based. ((Calendar)"2010-02-01").get(Calendar.MONTH)==1.	<a href="http://java.sun.com/javase/6/docs/api/java/util/Calendar.html#MONTH">http://java.sun.com/javase/6/docs/api/java/util/Calendar.html#MONTH</a>
WEEK_OF_YEAR	sP	int	-	Field number for the Calendar week. ((Calendar)"2010-02-01").get(Calendar.WEEK_OF_YEAR)==6.	<a href="http://java.sun.com/javase/6/docs/api/java/util/Calendar.html#WEEK_OF_YEAR">http://java.sun.com/javase/6/docs/api/java/util/Calendar.html#WEEK_OF_YEAR</a>
DAY_OF_YEAR	sP	int	-	Field number for the Calendar day of year. ((Calendar)"2010-02-01").get(Calendar.DAY_OF_YEAR)==32.	<a href="http://java.sun.com/javase/6/docs/api/java/util/Calendar.html#DAY_OF_YEAR">http://java.sun.com/javase/6/docs/api/java/util/Calendar.html#DAY_OF_YEAR</a>
DAY_OF_MONTH	sP	int	-	Field number for the Calendar day of month. ((Calendar)"2010-02-01").get(Calendar.DAY_OF_MONTH)==1.	<a href="http://java.sun.com/javase/6/docs/api/java/util/Calendar.html#DAY_OF_MONTH">http://java.sun.com/javase/6/docs/api/java/util/Calendar.html#DAY_OF_MONTH</a>
DAY_OF_WEEK	sP	int	-	Field number for the Calendar day of the week. ((Calendar)"2010-02-01").get(Calendar.DAY_OF_WEEK)==2.	<a href="http://java.sun.com/javase/6/docs/api/java/util/Calendar.html#DAY_OF_WEEK">http://java.sun.com/javase/6/docs/api/java/util/Calendar.html#DAY_OF_WEEK</a>
HOUR	sP	int	-	Field number for the Calendar hour, 12 hour format. ((Calendar)"2010-02-01T20:15:10").get(Calendar.HOUR)==8.	<a href="http://java.sun.com/javase/6/docs/api/java/util/Calendar.html#HOUR">http://java.sun.com/javase/6/docs/api/java/util/Calendar.html#HOUR</a>
AM_PM	sP	int	-	Field number for the Calendar AM_PM flag. 0 is for AM and 1 is for PM. ((Calendar)"2010-02-01T20:15:10").get(Calendar.AM_PM)==1.	<a href="http://java.sun.com/javase/6/docs/api/java/util/Calendar.html#AM_PM">http://java.sun.com/javase/6/docs/api/java/util/Calendar.html#AM_PM</a>
HOUR_OF_DAY	sP	int	-	Field number for the Calendar hour, 24 hour format. ((Calendar)"20:15:10").get(Calendar.HOUR)==20.	<a href="http://java.sun.com/javase/6/docs/api/java/util/Calendar.html#HOUR_OF_DAY">http://java.sun.com/javase/6/docs/api/java/util/Calendar.html#HOUR_OF_DAY</a>
MINUTE	sP	int	-	Field number for the Calendar minutes. JavaDate.from time string("20:15:10").get(Calendar.MINUTE)==15.	<a href="http://java.sun.com/javase/6/docs/api/java/util/Calendar.html#MINUTE">http://java.sun.com/javase/6/docs/api/java/util/Calendar.html#MINUTE</a>
SECOND	sP	int	-	Field number for Calendar seconds. ((Calendar)"20:15:10").get(Calendar.SECOND)==10.	<a href="http://java.sun.com/javase/6/docs/api/java/util/Calendar.html#SECOND">http://java.sun.com/javase/6/docs/api/java/util/Calendar.html#SECOND</a>

**Table B–14 (Cont.) Lists the Calendar Class**

OBR Name	Kind	Signature	Java Name	Description	Reference
ZONE_OFFSET	sP	int	-	Field number for timezone. Value is millisecond offset from GMT. ((Calendar)"20:15:10-05:30").get(Calendar.ZONE_OFFSET)==-(5*3600+30*60)*1000.	<a href="http://java.sun.com/javase/6/docs/api/java/util/Calendar.html#ZONE_OFFSET">http://java.sun.com/javase/6/docs/api/java/util/Calendar.html#ZONE_OFFSET</a>
add	M	void(int,int)	add	Adds the amount of time specified by arg2 to the calendar field specified by arg1. Modifies this Calendar.	<a href="http://java.sun.com/javase/6/docs/api/java/util/Calendar.html#add(int,%20int)">http://java.sun.com/javase/6/docs/api/java/util/Calendar.html#add(int,%20int)</a>
clear	M	void()	clear	Clears (unset all fields in) this Calendar. Modifies this Calendar.	<a href="http://java.sun.com/javase/6/docs/api/java/util/Calendar.html#clear()">http://java.sun.com/javase/6/docs/api/java/util/Calendar.html#clear()</a>
get	M	int(int)	get	Gets the value of the field specified by <i>field number</i> arg1. ((Calendar)"20:15:10").get(Calendar.SECOND)==10.	<a href="http://java.sun.com/javase/6/docs/api/java/util/Calendar.html#get(int)">http://java.sun.com/javase/6/docs/api/java/util/Calendar.html#get(int)</a>
getInstance	sM	Calendar()	getInstance	Gets a calendar initialized to the current time in the default time zone and locale.	<a href="http://java.sun.com/javase/6/docs/api/java/util/Calendar.html#getInstance()">http://java.sun.com/javase/6/docs/api/java/util/Calendar.html#getInstance()</a>
roll	M	void(int,int)	roll	Adds the amount of time specified by arg2 to the calendar field specified by arg1. Does not affect any other calendar field. Modifies this Calendar.	<a href="http://java.sun.com/javase/6/docs/api/java/util/Calendar.html#roll(int,%20int)">http://java.sun.com/javase/6/docs/api/java/util/Calendar.html#roll(int,%20int)</a>
set	M	void(int,int)	set	Sets the calendar field specified by arg1 to the value specified by arg2. Modifies this Calendar.	<a href="http://java.sun.com/javase/6/docs/api/java/util/Calendar.html#set(int,%20int)">http://java.sun.com/javase/6/docs/api/java/util/Calendar.html#set(int,%20int)</a>
time	P	java.util.Date	time	Returns a Date object representing this Calendar's time value. ((Calendar)"2010-02-01").time<((Calendar)"2010-02-02").time.	<a href="http://java.sun.com/javase/6/docs/api/java/util/Calendar.html#getTime()">http://java.sun.com/javase/6/docs/api/java/util/Calendar.html#getTime()</a>
timeInMillis	P	long	timeInMillis	Returns this Calendar's time value in milliseconds. ((Calendar)"2010-02-01").timeInMillis<((Calendar)"2010-02-02").timeInMillis.	<a href="http://java.sun.com/javase/6/docs/api/java/util/Calendar.html#getTimeInMillis()">http://java.sun.com/javase/6/docs/api/java/util/Calendar.html#getTimeInMillis()</a>

Table B–15 lists the `JavaDate` class.

**Table B–15 Lists the JavaDate Class**

OBR Name	Kind	Signature	Java Name	Description	Reference
JavaDate	Cl	-	oracle.rules.rl.extensions.JavaDate	Helper class for working with Calendars as immutable objects. Treating Calendars as immutable objects can help prevent errors.	<a href="http://download.oracle.com/docs/cd/E12839_01/apirefs.1111/e10663/oracle/rules/rl/extensions/JavaDate.html">http://download.oracle.com/docs/cd/E12839_01/apirefs.1111/e10663/oracle/rules/rl/extensions/JavaDate.html</a>
add years to	sM	Calendar(Calendar, int)	addYearsTo	Returns a new Calendar that is arg2 years later than arg1. <code>JavaDate.add years to("2009-01-01",1)=="2010-01-01".</code>	<a href="http://download.oracle.com/docs/cd/E12839_01/apirefs.1111/e10663/oracle/rules/rl/extensions/JavaDate.html#addYearsTo_java_util_Calendar__int_">http://download.oracle.com/docs/cd/E12839_01/apirefs.1111/e10663/oracle/rules/rl/extensions/JavaDate.html#addYearsTo_java_util_Calendar__int_</a>

**Table B-15 (Cont.) Lists the `JavaDate` Class**

OBR Name	Kind	Signature	Java Name	Description	Reference
add months to	sM	Calendar(Calendar, int)	addMonthsTo	Returns a new Calendar that is arg2 months later than arg1. JavaDate.add months to("2009-01-01",1)=="2009-02-01".	<a href="http://download.oracle.com/docs/cd/E12839_01/apirefs.1111/e10663/oracle/rules/rl/extensions/JavaDate.html#addMonthsTo_java_util_Calendar__int_">http://download.oracle.com/docs/cd/E12839_01/apirefs.1111/e10663/oracle/rules/rl/extensions/JavaDate.html#addMonthsTo_java_util_Calendar__int_</a>
add weeks to	sM	Calendar(Calendar, int)	addWeeksTo	Returns a new Calendar that is 7*arg2 days later than arg1. JavaDate.add weeks to("2009-01-01",1)=="2009-01-08".	<a href="http://download.oracle.com/docs/cd/E12839_01/apirefs.1111/e10663/oracle/rules/rl/extensions/JavaDate.html#addWeeksTo_java_util_Calendar__int_">http://download.oracle.com/docs/cd/E12839_01/apirefs.1111/e10663/oracle/rules/rl/extensions/JavaDate.html#addWeeksTo_java_util_Calendar__int_</a>
add days to	sM	Calendar(Calendar, int)	addDaysTo	Returns a new Calendar that is arg2 days later than arg1. JavaDate.add days to("2009-01-01",1)=="2009-01-02".	<a href="http://download.oracle.com/docs/cd/E12839_01/apirefs.1111/e10663/oracle/rules/rl/extensions/JavaDate.html#addDaysTo_java_util_Calendar__int_">http://download.oracle.com/docs/cd/E12839_01/apirefs.1111/e10663/oracle/rules/rl/extensions/JavaDate.html#addDaysTo_java_util_Calendar__int_</a>
add hours to	sM	Calendar(Calendar, int)	addHoursTo	Returns a new Calendar that is arg2 hours later than arg1. JavaDate.add hours to("01:01:01",1)=="02:01:01".	<a href="http://download.oracle.com/docs/cd/E12839_01/apirefs.1111/e10663/oracle/rules/rl/extensions/JavaDate.html#addHoursTo_java_util_Calendar__int_">http://download.oracle.com/docs/cd/E12839_01/apirefs.1111/e10663/oracle/rules/rl/extensions/JavaDate.html#addHoursTo_java_util_Calendar__int_</a>
add minutes to	sM	Calendar(Calendar, int)	addMinutesTo	Returns a new Calendar that is arg2 minutes later than arg1. JavaDate.add minutes to("01:01:01",1)=="01:02:01".	<a href="http://download.oracle.com/docs/cd/E12839_01/apirefs.1111/e10663/oracle/rules/rl/extensions/JavaDate.html#addMinutesTo_java_util_Calendar__int_">http://download.oracle.com/docs/cd/E12839_01/apirefs.1111/e10663/oracle/rules/rl/extensions/JavaDate.html#addMinutesTo_java_util_Calendar__int_</a>
add seconds to	sM	Calendar(Calendar, int)	addSecondsTo	Returns a new Calendar that is arg2 seconds later than arg1. JavaDate.add seconds to("01:01:01",61)=="01:02:02".	<a href="http://download.oracle.com/docs/cd/E12839_01/apirefs.1111/e10663/oracle/rules/rl/extensions/JavaDate.html#addSecondsTo_java_util_Calendar__int_">http://download.oracle.com/docs/cd/E12839_01/apirefs.1111/e10663/oracle/rules/rl/extensions/JavaDate.html#addSecondsTo_java_util_Calendar__int_</a>
add milliseconds to	sM	Calendar(Calendar, int)	addMillisecondsTo	Returns a new Calendar that is arg2 milliseconds later than arg1. JavaDate.add milliseconds to("01:01:01",61)=="01:01:01.061".	<a href="http://download.oracle.com/docs/cd/E12839_01/apirefs.1111/e10663/oracle/rules/rl/extensions/JavaDate.html#addMillisecondsTo_java_util_Calendar__int_">http://download.oracle.com/docs/cd/E12839_01/apirefs.1111/e10663/oracle/rules/rl/extensions/JavaDate.html#addMillisecondsTo_java_util_Calendar__int_</a>

**Table B–15 (Cont.) Lists the *JavaDate* Class**

OBR Name	Kind	Signature	Java Name	Description	Reference
add duration to	sM	Calendar(Calendar,XMLDuration)	addDurationTo	Returns a new Calendar that is later than arg1 by the duration arg2. <code>JavaDate.addDurationTo("2009-12-30T23:59:00",Duration.from(string("P1DT1M")))"=="2010-01-01"</code> .	<a href="http://www.w3.org/TR/rif-dtb/#func:add-dayTimeDuration-to-dateTime.29">http://www.w3.org/TR/rif-dtb/#func:add-dayTimeDuration-to-dateTime.29</a>  <a href="http://www.w3.org/TR/rif-dtb/#func:add-yearMonthDuration-to-dateTime.28adapted_from_op:add-yearMonthDuration-to-dateTime.29">http://www.w3.org/TR/rif-dtb/#func:add-yearMonthDuration-to-dateTime.28adapted_from_op:add-yearMonthDuration-to-dateTime.29</a>
from date string	sM	Calendar(String)	fromDateString	Creates a Calendar for the extended ISO 8601 date literal arg1. Extended to allow <code>YYYY-MM-DD@TimeZoneId</code> . <code>JavaDate.fromDateString("2010-02-06@PST)"=="2010-02-06-08:00"</code> .	<a href="http://download.oracle.com/docs/cd/E12839_01/apirefs.1111/e10663/oracle/rules/rl/extensions/JavaDate.html#fromDateString_java_lang_String_">http://download.oracle.com/docs/cd/E12839_01/apirefs.1111/e10663/oracle/rules/rl/extensions/JavaDate.html#fromDateString_java_lang_String_</a>
from datetime string	sM	Calendar(String)	fromDateTimeString	Creates a Calendar for the extended ISO 8601 datetime literal arg1. Extended to allow <code>YYYY-MM-DDTHH:MM:SS@TimeZoneId</code> . <code>JavaDate.fromDateTimeString("2010-02-06T14:15:00@PST)"=="2010-02-06T14:15:00-08:00"</code> .	<a href="http://download.oracle.com/docs/cd/E12839_01/apirefs.1111/e10663/oracle/rules/rl/extensions/JavaDate.html#fromDateTimeString_java_lang_String_">http://download.oracle.com/docs/cd/E12839_01/apirefs.1111/e10663/oracle/rules/rl/extensions/JavaDate.html#fromDateTimeString_java_lang_String_</a>
from time string	sM	Calendar(String)	fromTimeString	Creates a Calendar for the extended ISO 8601 time literal arg1. Extended to allow <code>HH:MM:SS@TimeZoneId</code> . Warning: the date portion of the Calendar will be initialized to the current date. <code>JavaDate.fromTimeString("14:15:00@PST)"=="14:15:00-08:00"</code> .	<a href="http://download.oracle.com/docs/cd/E12839_01/apirefs.1111/e10663/oracle/rules/rl/extensions/JavaDate.html#fromTimeString_java_lang_String_">http://download.oracle.com/docs/cd/E12839_01/apirefs.1111/e10663/oracle/rules/rl/extensions/JavaDate.html#fromTimeString_java_lang_String_</a>
subtract years from	sM	Calendar(Calendar,int)	subtractYearsFrom	Returns a new Calendar that is arg2 years earlier than arg1. <code>JavaDate.subtractYearsFrom("2009-01-01",1)"=="2008-01-01"</code> .	<a href="http://download.oracle.com/docs/cd/E12839_01/apirefs.1111/e10663/oracle/rules/rl/extensions/JavaDate.html#subtractYearsFrom_java_util_Calendar__int_">http://download.oracle.com/docs/cd/E12839_01/apirefs.1111/e10663/oracle/rules/rl/extensions/JavaDate.html#subtractYearsFrom_java_util_Calendar__int_</a>
subtract months from	sM	Calendar(Calendar,int)	subtractMonthsFrom	Returns a new Calendar that is arg2 months earlier than arg1. <code>JavaDate.subtractMonthsFrom("2009-01-01",1)"=="2008-12-01"</code> .	<a href="http://download.oracle.com/docs/cd/E12839_01/apirefs.1111/e10663/oracle/rules/rl/extensions/JavaDate.html#subtractMonthsFrom_java_util_Calendar__int_">http://download.oracle.com/docs/cd/E12839_01/apirefs.1111/e10663/oracle/rules/rl/extensions/JavaDate.html#subtractMonthsFrom_java_util_Calendar__int_</a>

**Table B–15 (Cont.) Lists the `JavaDate` Class**

OBR Name	Kind	Signature	Java Name	Description	Reference
subtract weeks from	sM	Calendar(Calendar ,int)	subtractWeeksFrom	Returns a new Calendar that is 7*arg2 days earlier than arg1. <code>JavaDate.subtract weeks from("2009-01-01",1)=="2008-12-25"</code> .	<a href="http://download.oracle.com/docs/cd/E12839_01/apirefs.1111/e10663/oracle/rules/rl/extensions/JavaDate.html#subtractWeeksFrom_java_util_Calendar__int_">http://download.oracle.com/docs/cd/E12839_01/apirefs.1111/e10663/oracle/rules/rl/extensions/JavaDate.html#subtractWeeksFrom_java_util_Calendar__int_</a>
subtract days from	sM	Calendar(Calendar ,int)	subtractDaysFrom	Returns a new Calendar that is arg2 days earlier than arg1. <code>JavaDate.subtract days from("2009-01-01",1)=="2008-12-31"</code> .	<a href="http://download.oracle.com/docs/cd/E12839_01/apirefs.1111/e10663/oracle/rules/rl/extensions/JavaDate.html#subtractDaysFrom_java_util_Calendar__int_">http://download.oracle.com/docs/cd/E12839_01/apirefs.1111/e10663/oracle/rules/rl/extensions/JavaDate.html#subtractDaysFrom_java_util_Calendar__int_</a>
subtract hours from	sM	Calendar(Calendar ,int)	subtractHoursFrom	Returns a new Calendar that is arg2 hours earlier than arg1. <code>JavaDate.subtract hours from("01:01:01",1)=="00:01:01"</code> .	<a href="http://download.oracle.com/docs/cd/E12839_01/apirefs.1111/e10663/oracle/rules/rl/extensions/JavaDate.html#subtractHoursFrom_java_util_Calendar__int_">http://download.oracle.com/docs/cd/E12839_01/apirefs.1111/e10663/oracle/rules/rl/extensions/JavaDate.html#subtractHoursFrom_java_util_Calendar__int_</a>
subtract minutes from	sM	Calendar(Calendar ,int)	subtractMinutesFrom	Returns a new Calendar that is arg2 minutes earlier than arg1. <code>JavaDate.subtract minutes from("01:01:01",1)=="01:00:01"</code> .	<a href="http://download.oracle.com/docs/cd/E12839_01/apirefs.1111/e10663/oracle/rules/rl/extensions/JavaDate.html#subtractMinutesFrom_java_util_Calendar__int_">http://download.oracle.com/docs/cd/E12839_01/apirefs.1111/e10663/oracle/rules/rl/extensions/JavaDate.html#subtractMinutesFrom_java_util_Calendar__int_</a>
subtract seconds from	sM	Calendar(Calendar ,int)	subtractSecondsFrom	Returns a new Calendar that is arg2 seconds earlier than arg1. <code>JavaDate.subtract seconds from("01:01:01",61)=="01:00:00"</code> .	<a href="http://download.oracle.com/docs/cd/E12839_01/apirefs.1111/e10663/oracle/rules/rl/extensions/JavaDate.html#subtractSecondsFrom_java_util_Calendar__int_">http://download.oracle.com/docs/cd/E12839_01/apirefs.1111/e10663/oracle/rules/rl/extensions/JavaDate.html#subtractSecondsFrom_java_util_Calendar__int_</a>
subtract milliseconds from	sM	Calendar(Calendar ,int)	subtractMillisecondsFrom	Returns a new Calendar that is arg2 milliseconds earlier than arg1. <code>JavaDate.subtract milliseconds from("01:01:01",61)=="01:01:00.939"</code> .	<a href="http://download.oracle.com/docs/cd/E12839_01/apirefs.1111/e10663/oracle/rules/rl/extensions/JavaDate.html#subtractMillisecondsFrom_java_util_Calendar__int_">http://download.oracle.com/docs/cd/E12839_01/apirefs.1111/e10663/oracle/rules/rl/extensions/JavaDate.html#subtractMillisecondsFrom_java_util_Calendar__int_</a>



**Table B–15 (Cont.) Lists the *JavaDate* Class**

OBR Name	Kind	Signature	Java Name	Description	Reference
subtract duration from	sM	Calendar(Calendar ,XMLDuration)	subtractDurationFrom	Returns a new Calendar that is earlier than arg1 by the duration arg2. <code>JavaDate.subtract duration from("2009-12-30T23:59:00",Duration.from string("P1DT1M"))=="2009-12-29T23:58:00"</code> .	<a href="http://www.w3.org/TR/rif-dtb/#func:add-dayTimeDuration-to-dateTime_.28adapted_from_op:subtract-dayTimeDuration-from-dateTime.29">http://www.w3.org/TR/rif-dtb/#func:add-dayTimeDuration-to-dateTime_.28adapted_from_op:subtract-dayTimeDuration-from-dateTime.29</a>  <a href="http://www.w3.org/TR/rif-dtb/#func:subtract-yearMonthDuration-from-dateTime_.28adapted_from_op:add-yearMonthDuration-to-dateTime.29">http://www.w3.org/TR/rif-dtb/#func:subtract-yearMonthDuration-from-dateTime_.28adapted_from_op:add-yearMonthDuration-to-dateTime.29</a>
to date string	sM	String(Calendar)	toDateString	Returns the ISO 8601 lexical representation of arg1, ignoring time components. <code>JavaDate.to date string("2010-07-04T12:30:00Z")== "2010-07-04Z"</code>	<a href="http://download.oracle.com/docs/cd/E12839_01/apirefs.1111/e10663/oracle/rules/rl/extensions/JavaDate.html#toDateString_java_util_Calendar_">http://download.oracle.com/docs/cd/E12839_01/apirefs.1111/e10663/oracle/rules/rl/extensions/JavaDate.html#toDateString_java_util_Calendar_</a>
to datetime string	sM	String(Calendar)	toDateTimeString	Returns the ISO 8601 lexical representation of arg1. <code>JavaDate.to datetime string("2010-07-04T12:30:00Z")== "2010-07-04T12:30:00.000Z"</code>	<a href="http://download.oracle.com/docs/cd/E12839_01/apirefs.1111/e10663/oracle/rules/rl/extensions/JavaDate.html#toDateTimeString_java_util_Calendar_">http://download.oracle.com/docs/cd/E12839_01/apirefs.1111/e10663/oracle/rules/rl/extensions/JavaDate.html#toDateTimeString_java_util_Calendar_</a>
to time string	sM	String(Calendar)	toTimeString	Returns the ISO 8601 lexical representation of arg1, ignoring date components. <code>JavaDate.to time string("2010-07-04T12:30:00Z")== "12:30:00.000Z"</code>	<a href="http://download.oracle.com/docs/cd/E12839_01/apirefs.1111/e10663/oracle/rules/rl/extensions/JavaDate.html#toTimeString_java_util_Calendar_">http://download.oracle.com/docs/cd/E12839_01/apirefs.1111/e10663/oracle/rules/rl/extensions/JavaDate.html#toTimeString_java_util_Calendar_</a>

Table B–16 lists the `XMLGregorianCalendar` class.

**Table B–16 Lists the *XMLGregorianCalendar* Class**

OBR Name	Kind	Signature	Java Name	Description	Reference
XMLGregorianCalendar	Cl	-	<code>javax.xml.datatype.XMLGregorianCalendar</code>	Representation for W3C XML Schema 1.0 date/time datatypes.	<a href="http://java.sun.com/javase/6/docs/api/javax/xml/datatype/XMLGregorianCalendar.html">http://java.sun.com/javase/6/docs/api/javax/xml/datatype/XMLGregorianCalendar.html</a>
normalize	M	<code>XMLGregorianCalendar()</code>	-	Normalizes this instance to UTC. <code>XMLDate.from string("2000-03-04T23:00+03:00").normalize()== XMLDate.from string("2000-03-04T20:00Z")</code>	<a href="http://java.sun.com/javase/6/docs/api/javax/xml/datatype/XMLGregorianCalendar.html#normalize()">http://java.sun.com/javase/6/docs/api/javax/xml/datatype/XMLGregorianCalendar.html#normalize()</a>

**Table B–16 (Cont.) Lists the XMLGregorianCalendar Class**

OBR Name	Kind	Signature	Java Name	Description	Reference
toGregorianCalendar	M	java.util.GregorianCalendar()	-	Converts this XMLGregorianCalendar to a (superclass of) Calendar. XMLDate.fromString("2010-02-03").toGregorianCalendar()==(Calendar)"2010-02-03".	<a href="http://java.sun.com/javase/6/docs/api/javax/xml/datatype/XMLGregorianCalendar.html#toGregorianCalendar()">http://java.sun.com/javase/6/docs/api/javax/xml/datatype/XMLGregorianCalendar.html#toGregorianCalendar()</a>
year	P	int	-	The year of this calendar, or Integer.MIN_VALUE if undefined. XMLDate.fromString("2011-12-31").year==2011.	<a href="http://java.sun.com/javase/6/docs/api/javax/xml/datatype/XMLGregorianCalendar.html#getYear()">http://java.sun.com/javase/6/docs/api/javax/xml/datatype/XMLGregorianCalendar.html#getYear()</a>
month	P	int	-	The month of this calendar, or Integer.MIN_VALUE if undefined. Months are 1-based, e.g. Jan is month 1. XMLDate.fromString("2011-12-31").month==12.	<a href="http://java.sun.com/javase/6/docs/api/javax/xml/datatype/XMLGregorianCalendar.html#getMonth()">http://java.sun.com/javase/6/docs/api/javax/xml/datatype/XMLGregorianCalendar.html#getMonth()</a>
day	P	int	-	The day of this calendar, or Integer.MIN_VALUE if undefined. XMLDate.fromString("2011-12-31").day==31.	<a href="http://java.sun.com/javase/6/docs/api/javax/xml/datatype/XMLGregorianCalendar.html#getDay()">http://java.sun.com/javase/6/docs/api/javax/xml/datatype/XMLGregorianCalendar.html#getDay()</a>
hour	P	int	-	The hour of this calendar, or Integer.MIN_VALUE if undefined. XMLDate.fromString("2011-12-31").hour==Integer.MIN_VALUE.	<a href="http://java.sun.com/javase/6/docs/api/javax/xml/datatype/XMLGregorianCalendar.html#getHour()">http://java.sun.com/javase/6/docs/api/javax/xml/datatype/XMLGregorianCalendar.html#getHour()</a>
minute	P	int	-	The minute of this calendar, or Integer.MIN_VALUE if undefined. XMLDate.fromString("2011-12-31T09:30:00").minute==30.	<a href="http://java.sun.com/javase/6/docs/api/javax/xml/datatype/XMLGregorianCalendar.html#getMinute()">http://java.sun.com/javase/6/docs/api/javax/xml/datatype/XMLGregorianCalendar.html#getMinute()</a>
second	P	int	-	The second of this calendar, or Integer.MIN_VALUE if undefined. XMLDate.fromString("09:30:05Z").second==5.	<a href="http://java.sun.com/javase/6/docs/api/javax/xml/datatype/XMLGregorianCalendar.html#getSecond()">http://java.sun.com/javase/6/docs/api/javax/xml/datatype/XMLGregorianCalendar.html#getSecond()</a>
timezone	P	int	-	The timezone offset in minutes of this calendar, or Integer.MIN_VALUE if undefined. XMLDate.fromString("09:30:00-09:00").timezone==-540.	<a href="http://java.sun.com/javase/6/docs/api/javax/xml/datatype/XMLGregorianCalendar.html#getTimezone()">http://java.sun.com/javase/6/docs/api/javax/xml/datatype/XMLGregorianCalendar.html#getTimezone()</a>

Table B–17 lists the XMLDate class.

**Table B-17** Lists the XMLDate Class

OBR Name	Kind	Signature	Java Name	Description	Reference
XMLDate	CI	-	oracle.rules.rl.extensions.XMLDate	Helper class for working with XMLGregorianCalendar as immutable objects. Treating calendars as immutable objects can help prevent errors.	<a href="http://download.oracle.com/docs/cd/E12839_01/apirefs.1111/e10663/oracle/rules/rl/extensions/XMLDate.html">http://download.oracle.com/docs/cd/E12839_01/apirefs.1111/e10663/oracle/rules/rl/extensions/XMLDate.html</a>
add years to	sM	XMLGregorianCalendar(XMLGregorianCalendar,int)	addYearsTo	Returns a new XMLGregorianCalendar that is arg2 years later than arg1. XMLDate.addYears("2009-01-01",1)=="2010-01-01".	<a href="http://download.oracle.com/docs/cd/E12839_01/apirefs.1111/e10663/oracle/rules/rl/extensions/XMLDate.html#addYearsTo_javax_xml_datatype_XMLGregorianCalendar_int_">http://download.oracle.com/docs/cd/E12839_01/apirefs.1111/e10663/oracle/rules/rl/extensions/XMLDate.html#addYearsTo_javax_xml_datatype_XMLGregorianCalendar_int_</a>
add months to	sM	XMLGregorianCalendar(XMLGregorianCalendar,int)	addMonthsTo	Returns a new XMLGregorianCalendar that is arg2 months later than arg1. XMLDate.addMonths("2009-01-01",1)=="2009-02-01".	<a href="http://download.oracle.com/docs/cd/E12839_01/apirefs.1111/e10663/oracle/rules/rl/extensions/XMLDate.html#addMonthsTo_javax_xml_datatype_XMLGregorianCalendar_int_">http://download.oracle.com/docs/cd/E12839_01/apirefs.1111/e10663/oracle/rules/rl/extensions/XMLDate.html#addMonthsTo_javax_xml_datatype_XMLGregorianCalendar_int_</a>
add weeks to	sM	XMLGregorianCalendar(XMLGregorianCalendar,int)	addWeeksTo	Returns a new XMLGregorianCalendar that is 7*arg2 days later than arg1. XMLDate.addWeeks("2009-01-01",1)=="2009-01-08".	<a href="http://download.oracle.com/docs/cd/E12839_01/apirefs.1111/e10663/oracle/rules/rl/extensions/XMLDate.html#addWeeksTo_javax_xml_datatype_XMLGregorianCalendar_int_">http://download.oracle.com/docs/cd/E12839_01/apirefs.1111/e10663/oracle/rules/rl/extensions/XMLDate.html#addWeeksTo_javax_xml_datatype_XMLGregorianCalendar_int_</a>
add days to	sM	XMLGregorianCalendar(XMLGregorianCalendar,int)	addDaysTo	Returns a new XMLGregorianCalendar that is arg2 days later than arg1. XMLDate.addDays("2009-01-01",1)=="2009-01-02".	<a href="http://download.oracle.com/docs/cd/E12839_01/apirefs.1111/e10663/oracle/rules/rl/extensions/XMLDate.html#addDaysTo_javax_xml_datatype_XMLGregorianCalendar_int_">http://download.oracle.com/docs/cd/E12839_01/apirefs.1111/e10663/oracle/rules/rl/extensions/XMLDate.html#addDaysTo_javax_xml_datatype_XMLGregorianCalendar_int_</a>
add hours to	sM	XMLGregorianCalendar(XMLGregorianCalendar,int)	addHoursTo	Returns a new XMLGregorianCalendar that is arg2 hours later than arg1. XMLDate.addHours("01:01:01",1)=="02:01:01".	<a href="http://download.oracle.com/docs/cd/E12839_01/apirefs.1111/e10663/oracle/rules/rl/extensions/XMLDate.html#addHoursTo_javax_xml_datatype_XMLGregorianCalendar_int_">http://download.oracle.com/docs/cd/E12839_01/apirefs.1111/e10663/oracle/rules/rl/extensions/XMLDate.html#addHoursTo_javax_xml_datatype_XMLGregorianCalendar_int_</a>
add minutes to	sM	XMLGregorianCalendar(XMLGregorianCalendar,int)	addMinutesTo	Returns a new XMLGregorianCalendar that is arg2 minutes later than arg1. XMLDate.addMinutes("01:01:01",1)=="01:02:01".	<a href="http://download.oracle.com/docs/cd/E12839_01/apirefs.1111/e10663/oracle/rules/rl/extensions/XMLDate.html#addMinutesTo_javax_xml_datatype_XMLGregorianCalendar_int_">http://download.oracle.com/docs/cd/E12839_01/apirefs.1111/e10663/oracle/rules/rl/extensions/XMLDate.html#addMinutesTo_javax_xml_datatype_XMLGregorianCalendar_int_</a>

**Table B-17 (Cont.) Lists the XMLDate Class**

OBR Name	Kind	Signature	Java Name	Description	Reference
add seconds to	sM	XMLGregorianCalendar(XMLGregorianCalendar,int)	addSecondsTo	Returns a new XMLGregorianCalendar that is arg2 seconds later than arg1. XMLDate.addSeconds to("01:01:01",61)=="01:02:02".	<a href="http://download.oracle.com/docs/cd/E12839_01/apirefs.1111/e10663/oracle/rules/r1/extensions/XMLDate.html#addSecondsTo_javax_xml_datatype_XMLGregorianCalendar_int_">http://download.oracle.com/docs/cd/E12839_01/apirefs.1111/e10663/oracle/rules/r1/extensions/XMLDate.html#addSecondsTo_javax_xml_datatype_XMLGregorianCalendar_int_</a>
add milliseconds to	sM	XMLGregorianCalendar(XMLGregorianCalendar,int)	addMillisecondsTo	Returns a new XMLGregorianCalendar that is arg2 milliseconds later than arg1. XMLDate.addMilliseconds to("01:01:01",61)=="01:01:01.061".	<a href="http://download.oracle.com/docs/cd/E12839_01/apirefs.1111/e10663/oracle/rules/r1/extensions/XMLDate.html#addMillisecondsTo_javax_xml_datatype_XMLGregorianCalendar_int_">http://download.oracle.com/docs/cd/E12839_01/apirefs.1111/e10663/oracle/rules/r1/extensions/XMLDate.html#addMillisecondsTo_javax_xml_datatype_XMLGregorianCalendar_int_</a>
add duration to	sM	XMLGregorianCalendar(XMLGregorianCalendar,XMLDuration)	addDurationTo	Returns a new XMLGregorianCalendar that is later than arg1 by the duration arg2. XMLDate.addDuration to("2009-12-30T23:59:00",Duration.fromString("P1DT1M"))=="2010-01-01".	<a href="http://www.w3.org/TR/rif-dtb/#func:add-yearMonthDuration-to-dateTime.28">http://www.w3.org/TR/rif-dtb/#func:add-yearMonthDuration-to-dateTime.28</a> adapted from <a href="http://www.w3.org/TR/rif-dtb/#func:add-dayTimeDuration-to-dateTime.29">http://www.w3.org/TR/rif-dtb/#func:add-dayTimeDuration-to-dateTime.29</a>
from string	sM	XMLGregorianCalendar(String)	fromString	Creates an XMLGregorianCalendar for the ISO 8601 date literal arg1. XMLDate.fromString("2010-02-06-08:00")=="2010-02-06-08:00".	<a href="http://download.oracle.com/docs/cd/E12839_01/apirefs.1111/e10663/oracle/rules/r1/extensions/XMLDate.html#fromString_java_lang_String_">http://download.oracle.com/docs/cd/E12839_01/apirefs.1111/e10663/oracle/rules/r1/extensions/XMLDate.html#fromString_java_lang_String_</a>
subtract years from	sM	XMLGregorianCalendar(XMLGregorianCalendar,int)	subtractYearsFrom	Returns a new XMLGregorianCalendar that is arg2 years earlier than arg1. XMLDate.subtractYears from("2009-01-01",1)=="2008-01-01".	<a href="http://download.oracle.com/docs/cd/E12839_01/apirefs.1111/e10663/oracle/rules/r1/extensions/XMLDate.html#subtractYearsFrom_javax_xml_datatype_XMLGregorianCalendar_int_">http://download.oracle.com/docs/cd/E12839_01/apirefs.1111/e10663/oracle/rules/r1/extensions/XMLDate.html#subtractYearsFrom_javax_xml_datatype_XMLGregorianCalendar_int_</a>
subtract months from	sM	XMLGregorianCalendar(XMLGregorianCalendar,int)	subtractMonthsFrom	Returns a new XMLGregorianCalendar that is arg2 months earlier than arg1. XMLDate.subtractMonths from("2009-01-01",1)=="2008-12-01".	<a href="http://download.oracle.com/docs/cd/E12839_01/apirefs.1111/e10663/oracle/rules/r1/extensions/XMLDate.html#subtractMonthsFrom_javax_xml_datatype_XMLGregorianCalendar_int_">http://download.oracle.com/docs/cd/E12839_01/apirefs.1111/e10663/oracle/rules/r1/extensions/XMLDate.html#subtractMonthsFrom_javax_xml_datatype_XMLGregorianCalendar_int_</a>
subtract weeks from	sM	XMLGregorianCalendar(XMLGregorianCalendar,int)	subtractWeeksFrom	Returns a new XMLGregorianCalendar that is 7*arg2 days earlier than arg1. XMLDate.subtractWeeks from("2009-01-01",1)=="2008-12-25".	<a href="http://download.oracle.com/docs/cd/E12839_01/apirefs.1111/e10663/oracle/rules/r1/extensions/XMLDate.html#subtractWeeksFrom_javax_xml_datatype_XMLGregorianCalendar_int_">http://download.oracle.com/docs/cd/E12839_01/apirefs.1111/e10663/oracle/rules/r1/extensions/XMLDate.html#subtractWeeksFrom_javax_xml_datatype_XMLGregorianCalendar_int_</a>

**Table B–17 (Cont.) Lists the XMLDate Class**

OBR Name	Kind	Signature	Java Name	Description	Reference
subtract days from	sM	XMLGregorianCalendar(XMLGregorianCalendar,int)	subtractDaysFrom	Returns a new XMLGregorianCalendar that is arg2 days earlier than arg1. XMLDate.subtract days from("2009-01-01",1)=="2008-12-31".	<a href="http://download.oracle.com/docs/cd/E12839_01/apirefs.1111/e10663/oracle/rules/rl/extensions/XMLDate.html#subtractDaysFrom_javax_xml_datatype_XMLGregorianCalendar__int_">http://download.oracle.com/docs/cd/E12839_01/apirefs.1111/e10663/oracle/rules/rl/extensions/XMLDate.html#subtractDaysFrom_javax_xml_datatype_XMLGregorianCalendar__int_</a>
subtract hours from	sM	XMLGregorianCalendar(XMLGregorianCalendar,int)	subtractHoursFrom	Returns a new XMLGregorianCalendar that is arg2 hours earlier than arg1. XMLDate.subtract hours from("01:01:01",1)=="00:01:01".	<a href="http://download.oracle.com/docs/cd/E12839_01/apirefs.1111/e10663/oracle/rules/rl/extensions/XMLDate.html#subtractHoursFrom_javax_xml_datatype_XMLGregorianCalendar__int_">http://download.oracle.com/docs/cd/E12839_01/apirefs.1111/e10663/oracle/rules/rl/extensions/XMLDate.html#subtractHoursFrom_javax_xml_datatype_XMLGregorianCalendar__int_</a>
subtract minutes from	sM	XMLGregorianCalendar(XMLGregorianCalendar,int)	subtractMinutesFrom	Returns a new XMLGregorianCalendar that is arg2 minutes earlier than arg1. XMLDate.subtract minutes from("01:01:01",1)=="01:00:01".	<a href="http://download.oracle.com/docs/cd/E12839_01/apirefs.1111/e10663/oracle/rules/rl/extensions/XMLDate.html#subtractMinutesFrom_javax_xml_datatype_XMLGregorianCalendar__int_">http://download.oracle.com/docs/cd/E12839_01/apirefs.1111/e10663/oracle/rules/rl/extensions/XMLDate.html#subtractMinutesFrom_javax_xml_datatype_XMLGregorianCalendar__int_</a>
subtract seconds from	sM	XMLGregorianCalendar(XMLGregorianCalendar,int)	subtractSecondsFrom	Returns a new XMLGregorianCalendar that is arg2 seconds earlier than arg1. XMLDate.subtract seconds from("01:01:01",61)=="01:00:00".	<a href="http://download.oracle.com/docs/cd/E12839_01/apirefs.1111/e10663/oracle/rules/rl/extensions/XMLDate.html#subtractSecondsFrom_javax_xml_datatype_XMLGregorianCalendar__int_">http://download.oracle.com/docs/cd/E12839_01/apirefs.1111/e10663/oracle/rules/rl/extensions/XMLDate.html#subtractSecondsFrom_javax_xml_datatype_XMLGregorianCalendar__int_</a>
subtract milliseconds from	sM	XMLGregorianCalendar(XMLGregorianCalendar,int)	subtractMillisecondsFrom	Returns a new XMLGregorianCalendar that is arg2 milliseconds earlier than arg1. XMLDate.subtract milliseconds from("01:01:01",61)=="01:01:00.939".	<a href="http://download.oracle.com/docs/cd/E12839_01/apirefs.1111/e10663/oracle/rules/rl/extensions/XMLDate.html#subtractMillisecondsFrom_javax_xml_datatype_XMLGregorianCalendar__int_">http://download.oracle.com/docs/cd/E12839_01/apirefs.1111/e10663/oracle/rules/rl/extensions/XMLDate.html#subtractMillisecondsFrom_javax_xml_datatype_XMLGregorianCalendar__int_</a>
subtract duration from	sM	XMLGregorianCalendar(XMLGregorianCalendar,XMLDuration)	subtractDurationFrom	Returns a new XMLGregorianCalendar that is earlier than arg1 by the duration arg2. XMLDate.subtract duration from("2009-12-30T23:59:00",Duration.fromString("P1DT1M"))=="2009-12-29T23:58:00".	<a href="http://www.w3.org/TR/rif-dtb/#func:subtract-yearMonthDuration-from-dateTime_.28_adapted_from_op:subtract-yearMonthDuration-from-dateTime.29">http://www.w3.org/TR/rif-dtb/#func:subtract-yearMonthDuration-from-dateTime_.28_adapted_from_op:subtract-yearMonthDuration-from-dateTime.29</a> <a href="http://www.w3.org/TR/rif-dtb/#func:subtract-dayTimeDuration-from-dateTime_.28_adapted_from_op:subtract-dayTimeDuration-from-dateTime.29">http://www.w3.org/TR/rif-dtb/#func:subtract-dayTimeDuration-from-dateTime_.28_adapted_from_op:subtract-dayTimeDuration-from-dateTime.29</a>

**Table B-17 (Cont.) Lists the XMLDate Class**

OBR Name	Kind	Signature	Java Name	Description	Reference
to string	sM	String(XMLGregorianCalendar)	toString	Returns the ISO 8601 lexical representation of arg1. XMLDate.toString("2010-04-15T11:00:00-09:00")=="2010-04-15T11:00:00-09:00".	<a href="http://download.oracle.com/docs/cd/E12839_01/apirefs.1111/e10663/oracle/rules/rl/extensions/XMLDate.html#toString_javax_xml_datatype_XMLGregorianCalendar_">http://download.oracle.com/docs/cd/E12839_01/apirefs.1111/e10663/oracle/rules/rl/extensions/XMLDate.html#toString_javax_xml_datatype_XMLGregorianCalendar_</a>
is datetime	sM	boolean(XMLGregorianCalendar)	isDateTime	Checks if this calendar have both date and time fields. XMLDate.isdatetime("2009-12-30T23:59:00")==true.	<a href="http://www.w3.org/TR/rif-dtb/#Guard_Predicates_for_Datatypes">http://www.w3.org/TR/rif-dtb/#Guard_Predicates_for_Datatypes</a>
is datetime stamp	sM	boolean(XMLGregorianCalendar)	isDateTimeStamp	Checks if this calendar have date, time, and timezone fields. XMLDate.isdatetimestamp("2009-12-30T23:59:00")==false.	<a href="http://www.w3.org/TR/rif-dtb/#Guard_Predicates_for_Datatypes">http://www.w3.org/TR/rif-dtb/#Guard_Predicates_for_Datatypes</a>
is date	sM	boolean(XMLGregorianCalendar)	isDate	Checks if this calendar have date fields and no time fields. XMLDate.isdate("2009-12-30")==true.	<a href="http://www.w3.org/TR/rif-dtb/#Guard_Predicates_for_Datatypes">http://www.w3.org/TR/rif-dtb/#Guard_Predicates_for_Datatypes</a>
is time	sM	boolean(XMLGregorianCalendar)	isTime	Checks if this calendar have time fields and no date fields. XMLDate.isTime("2009-12-30T23:59:00")==false.	<a href="http://www.w3.org/TR/rif-dtb/#Guard_Predicates_for_Datatypes">http://www.w3.org/TR/rif-dtb/#Guard_Predicates_for_Datatypes</a>
get timezone	sM	XMLDuration(XMLGregorianCalendar)	getTimezone	Gets the timezone from the calendar as a duration. XMLDate.getTimezone("11:00:00+05:30")==Duration.fromstring("PT5H30M").	<a href="http://www.w3.org/TR/rif-dtb/#func:timezone-from-dateTime_.28adapted_from_fn:timezone-from-dateTime.29">http://www.w3.org/TR/rif-dtb/#func:timezone-from-dateTime_.28adapted_from_fn:timezone-from-dateTime.29</a>
get seconds	sM	BigDecimal(XMLGregorianCalendar)	getSeconds	Gets the seconds, including fractional part, from the calendar as a BigDecimal. XMLDate.getseconds("00:00:12.345")==12.345.	<a href="http://www.w3.org/TR/rif-dtb/#func:seconds-from-dateTime_.28adapted_from_fn:seconds-from-dateTime.29">http://www.w3.org/TR/rif-dtb/#func:seconds-from-dateTime_.28adapted_from_fn:seconds-from-dateTime.29</a>

Table B-18 lists the OracleDate class.

**Table B-18 Lists the OracleDate Class**

OBR Name	Kind	Signature	Java Name	Description
OracleDate	Cl	-	oracle.rules.sdk2.extensions.OracleDate	Helper class for working with oracle.jbo.domain.Timestamp. For examples of method use, see like-named XMLDate methods.
add years to	sM	oracle.jbo.domain.Timestamp(oracle.jbo.domain.Timestamp,int)	addYearsTo	Returns a new oracle.jbo.domain.Timestamp that is arg2 years later than arg1.
add months to	sM	oracle.jbo.domain.Timestamp(oracle.jbo.domain.Timestamp,int)	addMonthsTo	Returns a new oracle.jbo.domain.Timestamp that is arg2 months later than arg1.
add weeks to	sM	oracle.jbo.domain.Timestamp(oracle.jbo.domain.Timestamp,int)	addWeeksTo	Returns a new oracle.jbo.domain.Timestamp that is 7*arg2 days later than arg1.

**Table B–18 (Cont.) Lists the OracleDate Class**

OBR Name	Kind	Signature	Java Name	Description
add days to	sM	oracle.jbo.domain.Timestamp(oracle.jbo.domain.Timestamp,int)	addDaysTo	Returns a new oracle.jbo.domain.Timestamp that is arg2 days later than arg1.
add hours to	sM	oracle.jbo.domain.Timestamp(oracle.jbo.domain.Timestamp,int)	addHoursTo	Returns a new oracle.jbo.domain.Timestamp that is arg2 hours later than arg1.
add minutes to	sM	oracle.jbo.domain.Timestamp(oracle.jbo.domain.Timestamp,int)	addMinutesTo	Returns a new oracle.jbo.domain.Timestamp that is arg2 minutes later than arg1.
add seconds to	sM	oracle.jbo.domain.Timestamp(oracle.jbo.domain.Timestamp,int)	addSecondsTo	Returns a new oracle.jbo.domain.Timestamp that is arg2 seconds later than arg1.
add milliseconds to	sM	oracle.jbo.domain.Timestamp(oracle.jbo.domain.Timestamp,int)	addMillisecondsTo	Returns a new oracle.jbo.domain.Timestamp that is arg2 milliseconds later than arg1.
add duration to	sM	oracle.jbo.domain.Timestamp(oracle.jbo.domain.Timestamp,XMLDuration)	addDurationTo	Returns a new oracle.jbo.domain.Timestamp that is later than arg1 by the duration arg2.
from string	sM	oracle.jbo.domain.Timestamp(String)	fromString	Creates an oracle.jbo.domain.Timestamp for the ISO 8601 date literal arg1.
subtract years from	sM	oracle.jbo.domain.Timestamp(oracle.jbo.domain.Timestamp,int)	subtractYearsFrom	Returns a new oracle.jbo.domain.Timestamp that is arg2 years earlier than arg1.
subtract months from	sM	oracle.jbo.domain.Timestamp(oracle.jbo.domain.Timestamp,int)	subtractMonthsFrom	Returns a new oracle.jbo.domain.Timestamp that is arg2 months earlier than arg1.
subtract weeks from	sM	oracle.jbo.domain.Timestamp(oracle.jbo.domain.Timestamp,int)	subtractWeeksFrom	Returns a new oracle.jbo.domain.Timestamp that is 7*arg2 days earlier than arg1.
subtract days from	sM	oracle.jbo.domain.Timestamp(oracle.jbo.domain.Timestamp,int)	subtractDaysFrom	Returns a new oracle.jbo.domain.Timestamp that is arg2 days earlier than arg1.
subtract hours from	sM	oracle.jbo.domain.Timestamp(oracle.jbo.domain.Timestamp,int)	subtractHoursFrom	Returns a new oracle.jbo.domain.Timestamp that is arg2 hours earlier than arg1.
subtract minutes from	sM	oracle.jbo.domain.Timestamp(oracle.jbo.domain.Timestamp,int)	subtractMinutesFrom	Returns a new oracle.jbo.domain.Timestamp that is arg2 minutes earlier than arg1.
subtract seconds from	sM	oracle.jbo.domain.Timestamp(oracle.jbo.domain.Timestamp,int)	subtractSecondsFrom	Returns a new oracle.jbo.domain.Timestamp that is arg2 seconds earlier than arg1.
subtract milliseconds from	sM	oracle.jbo.domain.Timestamp(oracle.jbo.domain.Timestamp,int)	subtractMillisecondsFrom	Returns a new oracle.jbo.domain.Timestamp that is arg2 milliseconds earlier than arg1.
subtract duration from	sM	oracle.jbo.domain.Timestamp(oracle.jbo.domain.Timestamp,XMLDuration)	subtractDurationFrom	Returns a new oracle.jbo.domain.Timestamp that is earlier than arg1 by the duration arg2.
to string	sM	String(oracle.jbo.domain.Timestamp)	toString	Returns the ISO 8601 lexical representation of arg1.

Table B–19 lists the Duration class.

**Table B-19** Lists the Duration Class

OBR Name	Kind	Signature	Java Name	Description	Reference
Duration	CI	-	oracle.rules.sdk2.extensions.OracleDuration	Helper class for comparing and subtracting dates. Can convert the difference of 2 dates into an XMLDuration. Can also create an XMLDuration from its literal (String) representation. Only day time and year month XMLDurations are supported.	-
compare	sM	int(Calendar   XMLGregorianCalendar   oracle.jbo.domain.Timestamp, Calendar   XMLGregorianCalendar   oracle.jbo.domain.Timestamp)	-	Returns -1, 0, or 1 according to whether arg1 < arg2, arg1 == arg2, or arg1 > arg2, respectively. Duration.compare("2010-01-01", "2010-02-02") == -1	<a href="http://www.w3.org/TR/rif-dtb/#pred:date-Time-less-than-.28adapted_from_op:dateTime-less-than.29">http://www.w3.org/TR/rif-dtb/#pred:date-Time-less-than-.28adapted_from_op:dateTime-less-than.29</a>
years between	sM	int(Calendar   XMLGregorianCalendar   oracle.jbo.domain.Timestamp, Calendar   XMLGregorianCalendar   oracle.jbo.domain.Timestamp)	yearsBetween	Subtracts arg1 from arg2, where the args are some kind of date/time. Duration.yearsBetween("2008-01-01", "2009-02-02") == 1.	-
months between	sM	int(Calendar   XMLGregorianCalendar   oracle.jbo.domain.Timestamp, Calendar   XMLGregorianCalendar   oracle.jbo.domain.Timestamp)	monthsBetween	Subtracts arg1 from arg2, where the args are some kind of date/time. Duration.monthsBetween("2009-01-01", "2008-02-02") == -10.	-
weeks between	sM	int(Calendar   XMLGregorianCalendar   oracle.jbo.domain.Timestamp, Calendar   XMLGregorianCalendar   oracle.jbo.domain.Timestamp)	weeksBetween	Subtracts arg1 from arg2, where the args are some kind of date/time. Duration.weeksBetween("2000-01-01", "2000-02-04") == 4.	-
days between	sM	int(Calendar   XMLGregorianCalendar   oracle.jbo.domain.Timestamp, Calendar   XMLGregorianCalendar   oracle.jbo.domain.Timestamp)	daysBetween	Subtracts arg1 from arg2, where the args are some kind of date/time. Duration.daysBetween("2000-01-01", "2000-02-04") == 34.	-
hours between	sM	int(Calendar   XMLGregorianCalendar   oracle.jbo.domain.Timestamp, Calendar   XMLGregorianCalendar   oracle.jbo.domain.Timestamp)	hoursBetween	Subtracts arg1 from arg2, where the args are some kind of date/time. Duration.hoursBetween("2000-01-04T03:30:00", "2000-01-01T00:00:00") == -75	-



**Table B–19 (Cont.) Lists the Duration Class**

OBR Name	Kind	Signature	Java Name	Description	Reference
minutes between	sM	int(Calendar   XMLGregorianCalendar   oracle.jbo.domain.Timestamp, Calendar   XMLGregorianCalendar   oracle.jbo.domain.Timestamp)	minutesBetween	Subtracts arg1 from arg2, where the args are some kind of date/time. Duration.minutes between("03:30:00","04:45:00")==75.	-
seconds between	sM	int(Calendar   XMLGregorianCalendar   oracle.jbo.domain.Timestamp, Calendar   XMLGregorianCalendar   oracle.jbo.domain.Timestamp)	secondsBetween	Subtracts arg1 from arg2, where the args are some kind of date/time. Duration.seconds between("03:30:00","03:31:15")==75.	-
milliseconds between	sM	int(Calendar   XMLGregorianCalendar   oracle.jbo.domain.Timestamp, Calendar   XMLGregorianCalendar   oracle.jbo.domain.Timestamp)	millisecondsBetween	Subtracts arg1 from arg2, where the args are some kind of date/time. Duration.milliseconds between("03:30:00","03:31:15")==75000.	-
between	sM	XMLDuration(Calendar   XMLGregorianCalendar   oracle.jbo.domain.Timestamp, Calendar   XMLGregorianCalendar   oracle.jbo.domain.Timestamp)	between	Subtracts arg1 from arg2, where the args are some kind of date/time. Returns day-time Duration. Duration.between("2009-01-01T01:15:00","2009-02-02T11:30:00")==Duration.from string("P32DT10H15M").	<a href="http://www.w3.org/TR/rif-dtb/#func:subtract-dateTimes.28adapted_from_op:subtract-dates.29">http://www.w3.org/TR/rif-dtb/#func:subtract-dateTimes.28adapted_from_op:subtract-dates.29</a>
from string	sM	XMLDuration(String)	fromString	Parses a duration from an ISO 8601 duration literal. "P1DT2H3M" is the duration of 1 day, 2 hours, and 3 minutes.	<a href="http://www.w3.org/TR/xfpath-functions/#duration-subtypes">http://www.w3.org/TR/xfpath-functions/#duration-subtypes</a>
compare durations	sM	int(XMLDuration, XMLDuration)	compareDurations	Compares two durations. Both must be either day-time or year-month durations. Returns -1, 0, or 1 according to whether arg1<arg2, arg1==arg2, or arg1>arg2, respectively. Duration.compare(Duration.from string("P1Y"),Duration.from string("P13M"))=-1.	<a href="http://www.w3.org/TR/rif-dtb/#pred:dayTimeDuration-less-than.28adapted_from_op:dayTimeDuration-less-than.29">http://www.w3.org/TR/rif-dtb/#pred:dayTimeDuration-less-than.28adapted_from_op:dayTimeDuration-less-than.29</a> <a href="http://www.w3.org/TR/rif-dtb/#pred:yearMonthDuration-less-than.28adapted_from_op:yearMonthDuration-less-than.29">http://www.w3.org/TR/rif-dtb/#pred:yearMonthDuration-less-than.28adapted_from_op:yearMonthDuration-less-than.29</a>
is day-time duration	sM	boolean(XMLDuration)	isDayTimeDuration	Checks if arg1 a day-time duration. Only day-time and year-month durations are supported. Duration.is day-time duration(Duration.from string("P2DT1S"))==true.	<a href="http://www.w3.org/TR/rif-dtb/#Guard_Predicates_for_Datatypes">http://www.w3.org/TR/rif-dtb/#Guard_Predicates_for_Datatypes</a>
is year-month duration	sM	boolean(XMLDuration)	isYearMonthDuration	Checks if arg1 a year-month duration. Only day-time and year-month durations are supported. Duration.is year-month duration(Duration.from string("P13M"))==true.	<a href="http://www.w3.org/TR/rif-dtb/#Guard_Predicates_for_Datatypes">http://www.w3.org/TR/rif-dtb/#Guard_Predicates_for_Datatypes</a>

**Table B–19 (Cont.) Lists the Duration Class**

OBR Name	Kind	Signature	Java Name	Description	Reference
get seconds	sM	BigDecimal(XMLDuration)	getSeconds	Gets the seconds field from the duration as a BigDecimal, including fractional seconds. Duration.getSeconds(Duraton.from string("PT12.345S"))==12.345.	<a href="http://www.w3.org/TR/rif-dtb/#func:seconds-from-duration_.28adapted_from_fn:seconds-from-duration.29">http://www.w3.org/TR/rif-dtb/#func:seconds-from-duration_.28adapted_from_fn:seconds-from-duration.29</a>
divide	sM	XMLDuration(XMLDuration,int double)	-	Divides a duration by an integral or double divisor. Duration.divide(Duration.from string("P1Y"),4)==Duration.from string("P3M").	<a href="http://www.w3.org/TR/rif-dtb/#func:divide-dayTimeDuration_.28adapted_from_op:divide-dayTimeDuration.29">http://www.w3.org/TR/rif-dtb/#func:divide-dayTimeDuration_.28adapted_from_op:divide-dayTimeDuration.29</a> <a href="http://www.w3.org/TR/rif-dtb/#func:divide-yearMonthDuration_.28adapted_from_op:divide-yearMonthDuration.29">http://www.w3.org/TR/rif-dtb/#func:divide-yearMonthDuration_.28adapted_from_op:divide-yearMonthDuration.29</a>
ratio	sM	BigDecimal(XMLDuration,XMLDuration)	-	Computes the ratio of 2 durations as a BigDecimal. Duration.ratio(Duration.from string("P1Y"),Duration.from string("P3M"))==4	<a href="http://www.w3.org/TR/rif-dtb/#func:divide-dayTimeDuration-by-dayTimeDuration_.28adapted_from_op:divide-dayTimeDuration-by-dayTimeDuration.29">http://www.w3.org/TR/rif-dtb/#func:divide-dayTimeDuration-by-dayTimeDuration_.28adapted_from_op:divide-dayTimeDuration-by-dayTimeDuration.29</a> <a href="http://www.w3.org/TR/rif-dtb/#func:divide-yearMonthDuration-by-yearMonthDuration_.28adapted_from_op:divide-yearMonthDuration-by-yearMonthDuration.29">http://www.w3.org/TR/rif-dtb/#func:divide-yearMonthDuration-by-yearMonthDuration_.28adapted_from_op:divide-yearMonthDuration-by-yearMonthDuration.29</a>

Table B–20 lists the XMLDuration class.

**Table B–20 Lists the XMLDuration Class**

OBR Name	Kind	Signature	Java Name	Description	Reference
XMLDuration	Cl	-	javax.xml.datatype.Duration	<b>Immutable representation of a time span as defined in the W3C XML Schema 1.0 specification. Only day-time and year-month XMLDurations are supported.</b>	<a href="http://java.sun.com/javase/6/docs/api/javax/xml/datatype/Duration.html">http://java.sun.com/javase/6/docs/api/javax/xml/datatype/Duration.html</a> <a href="http://www.w3.org/TR/xpath-functions/#duration-subtypes">http://www.w3.org/TR/xpath-functions/#duration-subtypes</a>
years	P	int	-	Years field of the duration. Duration.from string("P2Y3M").years==2.	<a href="http://www.w3.org/TR/rif-dtb/#func:years-from-duration_.28adapted_from_fn:years-from-duration.29">http://www.w3.org/TR/rif-dtb/#func:years-from-duration_.28adapted_from_fn:years-from-duration.29</a>
months	P	int	-	Months field of the duration. Duration.from string("P2Y3M").months==2.	<a href="http://www.w3.org/TR/rif-dtb/#func:months-from-duration_.28adapted_from_fn:months-from-duration.29">http://www.w3.org/TR/rif-dtb/#func:months-from-duration_.28adapted_from_fn:months-from-duration.29</a>

**Table B–20 (Cont.) Lists the XMLDuration Class**

OBR Name	Kind	Signature	Java Name	Description	Reference
days	P	int	-	Days field of the duration. Duration.from string("P1DT2H3M4S").days==1.	<a href="http://www.w3.org/TR/ri-f-dtb/#func:days-from-duration_.28adapted_from_fn:days-from-duration.29">http://www.w3.org/TR/ri-f-dtb/#func:days-from-duration_.28adapted_from_fn:days-from-duration.29</a>
hours	P	int	-	Hours field of the duration. Duration.from string("P1DT2H3M4S").hours==2.	<a href="http://www.w3.org/TR/ri-f-dtb/#func:hours-from-duration_.28adapted_from_fn:hours-from-duration.29">http://www.w3.org/TR/ri-f-dtb/#func:hours-from-duration_.28adapted_from_fn:hours-from-duration.29</a>
minutes	P	int	-	Minutes field of the duration. Duration.from string("P1DT2H3M4S").minutes==3.	<a href="http://www.w3.org/TR/ri-f-dtb/#func:minutes-from-duration_.28adapted_from_fn:minutes-from-duration.29">http://www.w3.org/TR/ri-f-dtb/#func:minutes-from-duration_.28adapted_from_fn:minutes-from-duration.29</a>
seconds	P	int	-	Seconds field of the duration. Duration.from string("P1DT2H3M4S").seconds==4.	<a href="http://www.w3.org/TR/ri-f-dtb/#func:seconds-from-duration_.28adapted_from_fn:seconds-from-duration.29">http://www.w3.org/TR/ri-f-dtb/#func:seconds-from-duration_.28adapted_from_fn:seconds-from-duration.29</a>
sign	P	int	-	Returns the sign of this duration in -1,0, or 1. Duration.from string("-P1Y").sign==-1.	-
add	M	XMLDuration(XMLDuration)	-	Adds two durations. Duration.from string("P6M").add(Duration.from string("P6M"))==Duration.from string("P1Y").	<a href="http://java.sun.com/javase/6/docs/api/javax/xml/datatype/Duration.html#add(javax.xml.datatype.Duration)">http://java.sun.com/javase/6/docs/api/javax/xml/datatype/Duration.html#add(javax.xml.datatype.Duration)</a>
subtract	M	XMLDuration(XMLDuration)	-	Subtracts two durations. Duration.from string("P6M").subtract(Duration.from string("P6M"))==Duration.from string("P0Y").	<a href="http://java.sun.com/javase/6/docs/api/javax/xml/datatype/Duration.html#subtract(javax.xml.datatype.Duration)">http://java.sun.com/javase/6/docs/api/javax/xml/datatype/Duration.html#subtract(javax.xml.datatype.Duration)</a>
multiply	M	XMLDuration(BigDecimal   int)	-	Multiplies arg1 duration by arg2 factor. Duration.from string("P6M").multiply(2)==Duration.from string("P1Y").	<a href="http://java.sun.com/javase/6/docs/api/javax/xml/datatype/Duration.html#multiply(java.math.BigDecimal)">http://java.sun.com/javase/6/docs/api/javax/xml/datatype/Duration.html#multiply(java.math.BigDecimal)</a>
negate	M	XMLDuration()	-	Durations can be negative, e.g. if you reverse the arguments to Duration.between(arg1,arg2). Duration.from string("P6M").negate()==Duration.from string("-P6M").	<a href="http://java.sun.com/javase/6/docs/api/javax/xml/datatype/Duration.html#negate()">http://java.sun.com/javase/6/docs/api/javax/xml/datatype/Duration.html#negate()</a>
to string	M	String()	toString	Gets the ISO8601 literal representation for this duration. Duration.from string("P6M").toString()=="P6M".	<a href="http://www.w3.org/TR/xpath-functions/#duration-subtypes">http://www.w3.org/TR/xpath-functions/#duration-subtypes</a>

Table B–21 lists the CurrentDate class.

**Table B-21** Lists the *CurrentDate* Class

OBR Name	Kind	Signature	Java Name	Description
CurrentDate	CI	-	oracle.rules.rl.extensions.CurrentDate	Fact type of a holder for the current date. Can be used in rule patterns.
date	P	Calendar	-	Returns the current date.

## B.5 Miscellaneous Classes

This section covers the miscellaneous classes provided by Oracle Business Rules.

[Table B-22](#) lists the *JAXBElement* class.

**Table B-22** Lists the *JAXBElement* Class

OBR Name	Kind	Signature	Java Name	Description	Reference
JAXBElement	CI	-	javax.xml.bind.JAXBElement	Represents XML element information in XML Fact Types.	<a href="http://java.sun.com/javase/6/docs/api/javax/xml/bind/JAXBElement.html">http://java.sun.com/javase/6/docs/api/javax/xml/bind/JAXBElement.html</a>
nil	P	boolean	-	A nil element is not the same thing (in XML) as an absent element.	<a href="http://java.sun.com/javase/6/docs/api/javax/xml/bind/JAXBElement.html#isNil()">http://java.sun.com/javase/6/docs/api/javax/xml/bind/JAXBElement.html#isNil()</a>
value	P	Object	-	This is a reference to an XML Fact Type	<a href="http://java.sun.com/javase/6/docs/api/javax/xml/bind/JAXBElement.html#getValue()">http://java.sun.com/javase/6/docs/api/javax/xml/bind/JAXBElement.html#getValue()</a>

[Table B-23](#) lists the *Object* class.

**Table B-23** Lists the *Object* Class

OBR Name	Kind	Signature	Java Name	Description	Reference
Object	CI	-	java.lang.Object	Base class of all Java objects.	<a href="http://java.sun.com/javase/6/docs/api/java/lang/Object.html">http://java.sun.com/javase/6/docs/api/java/lang/Object.html</a>

## B.6 Functions

[Table B-24](#) lists the different functions provided by Oracle Business Rules.

**Table B-24** Lists the different functions provided by Oracle Business Rules

OBR Name	Signature	RL Name	Description	Reference
print	void(Object)	println	Prints the string value of arg1.	Oracle Fusion Middleware Language Reference Guide for Oracle Business Rules
RL.assert a tree of facts	Object(Object)	assertTree	Asserts (insert into working memory) the tree of visible fact types with arg1 as the root. Returns arg1.	Oracle Fusion Middleware Language Reference Guide for Oracle Business Rules
RL.assert	Object(Object)	assert	Asserts arg1 (insert arg1 into working memory). Returns arg1.	Oracle Fusion Middleware Language Reference Guide for Oracle Business Rules
RL.retract	void(Object)	retract	Removes the fact associated with the object arg1 from working memory.	Oracle Fusion Middleware Language Reference Guide for Oracle Business Rules

**Table B–24 (Cont.) Lists the different functions provided by Oracle Business Rules**

OBR Name	Signature	RL Name	Description	Reference
RL.get fact ID	int(Object)	id	Returns the fact id associated with the object arg1. If arg1 is not associated with a fact, return -1.	Oracle Fusion Middleware Language Reference Guide for Oracle Business Rules
RL.get fact by ID	Object(int)	object	Returns the object associated with the given fact id. If there is no such fact id, returns null.	Oracle Fusion Middleware Language Reference Guide for Oracle Business Rules
RL.contains	boolean(List,Object)	contains	The contains() function is similar to the contains() method on Java Collection but includes the ability to handle the presence of JAXBElement in the collection.	Oracle Fusion Middleware Language Reference Guide for Oracle Business Rules
RL.ruleset stack.push	void(String)	pushRuleset	Pushes arg1, the name of a ruleset, onto the ruleset stack.	Oracle Fusion Middleware Language Reference Guide for Oracle Business Rules
RL.ruleset stack.pop	String()	popRuleset	Pops and returns the top of the ruleset stack, the name of a ruleset.	Oracle Fusion Middleware Language Reference Guide for Oracle Business Rules
RL.ruleset stack.get	String[]()	getRulesetStack	Returns the ruleset stack as a String array.	Oracle Fusion Middleware Language Reference Guide for Oracle Business Rules
RL.ruleset stack.set	void(String[])	setRulesetStack	Sets the ruleset stack to arg1, a String array.	Oracle Fusion Middleware Language Reference Guide for Oracle Business Rules
RL.ruleset stack.clear	void()	clearRulesetStack	Pops all ruleset names off the ruleset stack.	Oracle Fusion Middleware Language Reference Guide for Oracle Business Rules
RL.date.get current	Calendar()	getCurrentDate	Returns the date associated with the CurrentDate fact.	Oracle Fusion Middleware Language Reference Guide for Oracle Business Rules
RL.date.set current	void(Calendar)	setCurrentDate	Sets the date for reasoning on an engine managed fact representing the "current" date (with the CurrentDate fact).	Oracle Fusion Middleware Language Reference Guide for Oracle Business Rules
RL.date.get effective	Calendar()	getEffectiveDate	Returns the current value of the effective date.	Oracle Fusion Middleware Language Reference Guide for Oracle Business Rules
RL.date.set effective	void(Calendar)	setEffectiveDate	Updates the effective date in the rules engine.	Oracle Fusion Middleware Language Reference Guide for Oracle Business Rules
RL.watch.rules	void()	watchRules	Prints information about rule firings (execution of activations).	Oracle Fusion Middleware Language Reference Guide for Oracle Business Rules
RL.watch.activations	void()	watchActivations	Prints information about addition or removal of activations from the agenda.	Oracle Fusion Middleware Language Reference Guide for Oracle Business Rules

**Table B–24 (Cont.) Lists the different functions provided by Oracle Business Rules**

<b>OBR Name</b>	<b>Signature</b>	<b>RL Name</b>	<b>Description</b>	<b>Reference</b>
RL.watch.facts	void()	watchFacts	Prints information about assertion, retraction, or modification of facts in working memory.	Oracle Fusion Middleware Language Reference Guide for Oracle Business Rules
RL.watch.focus	void()	watchFocus	Prints information about pushing and popping of the ruleset stack.	Oracle Fusion Middleware Language Reference Guide for Oracle Business Rules
RL.watch.compilations	void()	watchCompilations	Prints information about how the condition parts of a rule are shared with existing rules.	Oracle Fusion Middleware Language Reference Guide for Oracle Business Rules
RL.watch.all	void()	watchAll	Prints information about rules, facts, activations, focus, and compilations.	Oracle Fusion Middleware Language Reference Guide for Oracle Business Rules
RL.stop watching.rules	void()	clearWatchRules	Stops printing information about rule firings.	Oracle Fusion Middleware Language Reference Guide for Oracle Business Rules
RL.stop watching.activations	void()	clearWatchActivations	Stops printing information about addition or removal of activations from the agenda.	Oracle Fusion Middleware Language Reference Guide for Oracle Business Rules
RL.stop watching.facts	void()	clearWatchFacts	Stops printing information about assertion, retraction, or modification of facts in working memory.	Oracle Fusion Middleware Language Reference Guide for Oracle Business Rules
RL.stop watching.focus	void()	clearWatchFocus	Stops printing information about pushing and popping of the ruleset stack.	Oracle Fusion Middleware Language Reference Guide for Oracle Business Rules
RL.stop watching.compilations	void()	clearWatchCompilations	Stops printing information about how the condition parts of a rule are shared with existing rules.	Oracle Fusion Middleware Language Reference Guide for Oracle Business Rules
RL.stop watching.all	void()	clearWatchAll	Stops printing information about rules, facts, activations, focus, and compilations.	Oracle Fusion Middleware Language Reference Guide for Oracle Business Rules
RL.show.facts	void()	showFacts	Prints all facts in working memory.	Oracle Fusion Middleware Language Reference Guide for Oracle Business Rules
RL.show.activations	void()	showActivations	Prints all activations on the agenda.	Oracle Fusion Middleware Language Reference Guide for Oracle Business Rules

---

---

## Oracle Business Rules Frequently Asked Questions

This appendix contains frequently asked questions about Oracle Business Rules.

- Section C.1, "Why Do Rules Not Fire When A Java Object is Asserted as a Fact and Then Changed Without Using the Modify Action?"
- Section C.2, "What are the Differences Between Oracle Business Rules RL Language and Java?"
- Section C.3, "How Does a RuleSession Handle Concurrency and Synchronization?"
- Section C.4, "How Do I Correctly Express a Self-Join?"
- Section C.5, "How Do I Use a Property Change Listener in Oracle Business Rules?"
- Section C.6, "What Are the Limitations on a Decision Service with Oracle Business Rules?"
- Section C.7, "How Do I Put Java Code in a Rule?"
- Section C.8, "Can I Use Java Based Facts in a Decision Service with BPEL?"
- Section C.9, "How Do I Enable Debugging in a BPEL Decision Service?"
- Section C.10, "How Do I Support Versioning with Oracle Business Rules?"
- Section C.11, "What is the Priority Order Using Priorities with Rules and Decision Tables?"
- Section C.12, "Why do XML Schema with xsd:string Typed Elements Import as Type JAXBElement?"
- Section C.13, "Why Are Changes to My Java Classes Not Reflected in the Data Model?"
- Section C.14, "How Do I Use Rules SDK to Include a null in an Expression?"
- Section C.15, "Is WebDAV Supported as a Repository to Store a Dictionary?"
- Section C.16, "Using a Source Code Control System with Rules Designer"

### C.1 Why Do Rules Not Fire When A Java Object is Asserted as a Fact and Then Changed Without Using the Modify Action?

When a Java object has been asserted and then the object is changed without using the modify action, the object must be re-asserted in the Rules Engine. Therefore, if a rule associated with the changed Java object does not fire, this means that the Rules Engine did not reevaluate any rule conditions and did not activate any rules. Thus, when a

Java object changes without using the modify action, the object must be re-asserted in the Rules Engine.

## C.2 What are the Differences Between Oracle Business Rules RL Language and Java?

For more information on the differences between Oracle Business Rules RL Language and Java, see Appendix A in *Rules Language Reference for Oracle Business Process Management*.

## C.3 How Does a RuleSession Handle Concurrency and Synchronization?

Method calls on an Oracle Business Rules RuleSession object are thread-safe such that calls by multiple threads do not cause exceptions at the RuleSession level. However, there are no exclusivity or transactional guarantees on the execution of methods. The lowest-level run method in the Rules Engine is synchronized, so two threads with a shared RuleSession cannot both simultaneously execute run. One call to run must wait for the other to finish.

Oracle Business Rules functions are not synchronized by default. Like Java methods, Oracle Business Rules functions can execute concurrently and it is the programmer's responsibility to use synchronized blocks to protect access to shared data (for instance, a HashMap containing results data).

Any set of actions that a user wants to be executed as in a transaction-like form must synchronize around the shared object. Users should not synchronize around a RuleSession object because exceptions thrown when calling RuleSession methods may require the RuleSession object to be discarded.

For most uses of a RuleSession object in Oracle Business Rules, each thread or servlet instance should create and use a local RuleSession object. This usage pattern is roughly analogous to using a JDBC connection in this manner.

The following examples demonstrate how to use a shared RuleSession object.

For the case where Thread-1 includes the following:

```
ruleSession.callFunctionWithArgument("assert", singleFact1);  
ruleSession.callFunctionWithArgument("assert", singleFact2);
```

and Thread-2 includes the following:

```
ruleSession.callFunction("run");  
ruleSession.callFunction("clear");
```

In this case, the execution of the two threads might proceed as shown in [Example C-1](#).

### **Example C-1 Using a Shared RuleSession Object in Oracle Business Rules**

```
Thread-1: ruleSession.callFunctionWithArgument("assert", singleFact1);  
Thread-2: ruleSession.callFunction("run");  
Thread-2: ruleSession.callFunction("clear");  
Thread-1: ruleSession.callFunctionWithArgument("assert", singleFact2);
```

In [Example C-1](#), the two facts Thread-1 asserted are never both in the RuleSession during a call to run. Notice also that only one thread calls the run method. If you use a design where multiple threads can call run on a shared RuleSession, this can create extremely hard to find bugs and there is usually no gain in performance.



All accesses to a shared `RuleSession` object must be synchronized to ensure the intended behavior. However, a `RuleSession` instance may throw an exception and not be recoverable, so do not use this object as the synchronization object. Instead, use another shared object as the synchronization point.

One can envision a shared server process producer-consumer model for `RuleSession` use. In this model, multiple threads assert facts to a shared `RuleSession` and one thread periodically calls `run`, reads any results, and outputs them. This ensures that thread conflicts cannot occur, because the two code segments must be executed serially and cannot be intermingled. For example, the code with shared objects, producer code, and consumer code in [Example C-2](#), [Example C-3](#), and [Example C-4](#).

#### **Example C-2 RuleSession Shared Objects**

```
RuleSession ruleSession;
Object ruleSessionLock = new Object();
```

#### **Example C-3 RuleSession Producer Code**

```
public String addFacts(FactTypeA fa, FactTypeB fb, FactTypeC fc){
    String status = "";
    synchronized(ruleSessionLock){
        try {
            ruleSession.callFunctionWithArgument("assert", fa);
            ruleSession.callFunctionWithArgument("assert", fb);
            status = "success";
        } catch (Exception e) {
            // a method that creates a new RuleSession loads it with rules
            initializeRuleSession();
            status = "failure";
        }
    }
    return status;
}
```

#### **Example C-4 RuleSession Consumer Code**

```
public List exec(){
    synchronized(ruleSessionLock){
        try {
            ruleSession.callFunction("run");
            List results = (List)ruleSession.callFunction("getResults");
            ruleSession.callFunction("clearResults");
            return results;
        } catch (Exception e) {
            // a method that creates a new RuleSession loads it with rules
            initializeRuleSession();
            return null;
        }
    }
}
```

---



---

**Note:** When multiple threads are sharing a `RuleSession` object, if more than one of the threads calls the `run` method, this can create extremely hard to find bugs and there is usually no gain in performance.

---



---

## **C.4 How Do I Correctly Express a Self-Join?**

When working with facts, there are cases where the runtime behavior of Oracle RL may produce surprising results.

Consider the Oracle RL code in [Example C-5](#).

**Example C-5 Self-Join Using Fact F**

```
class F {int i; };
rule r1 {
  if (fact F f1 && fact F f2) {
    println("Results: " + f1.i + ", " + f2.i);
  }
}
assert(new F(i:1));
assert(new F(i:2));
run();
```

How many lines print in the [Example C-5](#) output? The answer is 4 lines because the same fact instance can match for both f1 and f2.

Thus, [Example C-5](#) gives the following output:

```
Results: 2, 2
Results: 2, 1
Results: 1, 2
Results: 1, 1
```

Using the same example with a third F, for example (`assert(new F(i:3));`) then nine lines are printed and if, at the same time, a third term `&& fact F F3` is added then 27 lines are printed.

If you are attempting to find all combinations and orders of distinct facts, you need an additional term to in the test, as shown in [Example C-6](#).

**Example C-6 Find All Combinations of Fact F**

```
rule r1 {
  if (fact F F1 && fact F F2 && F1 != F2) {
    println("Results: " + F1.i + ", " + F2.i);
  }
}
```

The code in [Example C-6](#) gives the following output:

```
Results: 2, 1
Results: 1, 2
```

The simplest, although not the fastest way to find all combinations of facts, regardless of their order, is to use the code shown in [Example C-7](#).

**Example C-7 Finding Combinations of Fact F**

```
rule r1 {
  if (fact F F1 && fact F F2 && id(F1) < id(F2)) {
    println("Results: " + F1.i + ", " + F2.i);
  }
}
```

Because the function `id()` shown in [Example C-7](#) takes longer to execute in a test pattern than a direct comparison, the fastest method is to test on a unique value in each object. For example, you could add an integer value property "oid" to your class that is assigned a unique value for each instance of the class.

[Example C-8](#) shows the same rule using the oid value.

**Example C-8 Fast Complete Comparison**

```
rule r1 {
```

```

if (fact F F1 && fact F F2 && F1.oid < F2.oid) {
    println("Results: " + F1.i + ", " + F2.i);
}
}

```

This problem may also arise if you attempt to remove all duplicate facts from the Oracle Rules Engine, using a function as shown [Example C-9](#).

#### **Example C-9 Retracting Duplicate Facts Incorrect Sample**

```

rule rRemoveDups {
    if (fact F F1 && fact F F2 && F1.i == F2.i) {
        retract(F2);
    }
}

```

However, this rule removes all facts of type F, not just the duplicates because F1 and F2 may be the same fact instance. [Example C-10](#) shows the correct version of this rule.

#### **Example C-10 Retracting Duplicate Facts Corrected Sample**

```

rule rRemoveDups {
    if (fact F F1 && fact F F2 && F1 != F2 && F1.i == F2.i) {
        retract(F2);
    }
}

```

## C.5 How Do I Use a Property Change Listener in Oracle Business Rules?

The Oracle Rules Engine supports the Java `PropertyChangeListener` design pattern. This allows an instance of a Java fact that uses the `PropertyChangeSupport` class to automatically notify the Oracle Rules Engine when property values have changed. Java facts are not required to implement this pattern to be used by Oracle Rules Engine.

Typically, changes made to values of a property of a Java object that has previously been asserted to the Oracle Rules Engine requires that the object be re-asserted in order for rules to be reevaluated with the new property value. For properties that fire `PropertyChangeEvent`, changing the value of those properties both changes the value and re-asserts the fact to the Oracle Rules Engine.

To implement the `PropertyChangeListener` design pattern in a class, do the following:

1. Import this package in the class:

```
import java.beans.PropertyChangeSupport;
```

2. Add a private member variable to the class:

```
private PropertyChangeSupport m_pcs = null;
```

3. In the constructor, create a new `PropertyChangeSupport` object:

```
m_pcs = new PropertyChangeSupport(this);
```

4. Then for each setter, add the call to `firePropertyChange`:

```
public void setName( String name ){
    String oldVal = m_name;
    m_name = name;
    m_pcs.firePropertyChange( "name", oldVal, m_name );
}

```

5. Implement `addPropertyChangeListener` method (delegate to `m_pcs`):

```
public void addPropertyChangeListener(PropertyChangeListener pcl){
    m_pcs.addPropertyChangeListener( pcl );
}
```

6. Implement `removePropertyChangeListener` method (delegate to `m_pcs`):

```
public removePropertyChangeListener(PropertyChangeListener pcl){
    m_pcs.removePropertyChangeListener( pcl );
}
```

When deciding whether to design your application to always explicitly re-assert modified objects or implement the `PropertyChangeListener` design pattern, consider the following:

- Explicitly re-asserting modified objects allows a user to group several property changes and making them visible to the rules all at once. This is most useful when a concurrent thread is executing rules, and the rules should see only a complete group of property changes.
- Explicit assert reduces the computational cost of rule re-evaluation when multiple properties are changed. If multiple properties are changed at the same time, this results in multiple re-evaluations of rule conditions that reference the fact type. This occurs because each property change event results in a re-assertion of the object. Using an explicit assert instead of the `PropertyChangeListener` pattern eliminates this extra computational cost.
- Explicit assert is required when a rule modifies a fact that is also tested in its condition, but the automatic reassert triggered by the `PropertyChangeListener` before a guard condition property is set would cause the rule to re-fire itself endlessly.
- Explicit assert must be used when modifying Oracle RL facts and XML facts, because these cannot be defined to support the `PropertyChangeListener` design pattern.
- `PropertyChangeListener`-enabled facts allow a Java application to communicate property changes to the rule engine without having to change the application to perform explicit asserts. This also means that code that modifies a property of an object does not need to have a reference to the `RuleSession` object in scope.
- `PropertyChangeListener` support prevents the common error of neglecting to re-assert a fact after changing its properties.

## C.6 What Are the Limitations on a Decision Service with Oracle Business Rules?

There are some limitations for using Business Rules with a BPEL process, including the following:

- Only visible XML fact types may be specified as the input for a decision service.
- Only visible XML fact types may be specified as the output of a decision service.

For an additional restriction, see [Appendix D.8, "How Are Decision Service Input Output Element Types Restricted?"](#).

For information on setting XML fact type visible option, see [Section 3.2, "Working with XML Facts"](#).

## C.7 How Do I Put Java Code in a Rule?

You do not actually put Java code in a rule. However, you can invoke a Java method from a rule condition or action.

## C.8 Can I Use Java Based Facts in a Decision Service with BPEL?

Oracle BPEL PM can invoke only decision functions exposed as a decision service, and this means that the decision function inputs and outputs must be XML fact types.

You can use an existing ruleset or decision function that uses Java fact types if you convert the input XML facts to Java facts. For example, you could create some rules in a ruleset, named `convertFromXML`, and put this ruleset before the Java ruleset in the decision function ruleflow. Similarly, you could create a ruleset to convert from Java facts to output XML facts and put this ruleset after the Java ruleset in the decision function ruleflow.

Alternatively, if your rules use only properties, and no methods or fields, from the Java fact types you can replace the Java fact types with XML fact types as follows:

1. Delete the Java fact types (first making careful note of the aliases of the fact types and properties).
2. Import similar XML fact types and edit the aliases of the fact types and properties to be the same as the deleted Java fact types and properties.

## C.9 How Do I Enable Debugging in a BPEL Decision Service?

To enable debugging output during ruleset execution for a BPEL Decision Service, you enable the SOA rules logger. When the SOA rules logger is set to `TRACE` level then the output of `watchAll` is logged to the SOA diagnostic log. When you change the logging level using Fusion Middleware Control Console, you do not need to redeploy the application to use the specified level.

For information on using the SOA `oracle.soa.service.rules` and `oracle.soa.services.rules.obrtrace` loggers, see *Administering Oracle SOA Suite and Oracle Business Process Management Suite*.

## C.10 How Do I Support Versioning with Oracle Business Rules?

Versioning is supported in Oracle Business Rules in two ways:

- At design time, the dictionary is stored as an XML file in a JDeveloper project. The dictionary can be versioned in a source control system in the same way as any other source file.
- At runtime, the dictionary is stored in MDS. If MDS is database backed then versioning is supported using MDS.

Note: It is possible for a server application to respond to dictionary changes as they are made visible to the application in MDS. The rule service engine (decision service) does this automatically. For non-SCA application, this can be done using the `RuleRepository` interface. At this time, the way to support an "in-draft" version is by using the sandbox feature of MDS. The Oracle Business Rules `RuleRepository` interface supports this.

## C.11 What is the Priority Order Using Priorities with Rules and Decision Tables?

The priority for rules and decision tables is highest to lowest, with the higher priority rule or Decision Table executing first. For example, if you create rules with priorities 1-4, they would be executed in the execution priority order 4,3,2,1. Using Rules Designer you can select a priority from a predefined named priority list or enter a positive or negative integer to specify your own priority level. The default priority is medium (with the integer value 0). For more information, see [Section 4.5.5, "How to Set a Priority for a Rule"](#).

Note, however, you should try to avoid priorities as much as possible since they break the purely declarative model of rules. If you find yourself using a lot of priorities, then generally it is best to try to restructure your rule patterns and tests to avoid conflicts, or divide the rules into multiple rulesets using ruleflow if they are intended to be run in a certain order. A conflict is a case when more than one rule in a ruleset is able to fire. For example, if a "gold customer" rule says to make a customer that spends over \$1000 a gold customer, and a "silver customer" rule says to make a customer that spends over \$500 a silver customer, then when a customer spends \$1100 there is a conflict. Rather than prioritize the rules, it is more declarative to change the "silver customer" rule to test for customers that spend *between* \$500 and \$1000. This conflict analysis and conflict avoidance is particularly easy if you use Decision Tables. For more information on Decision Tables, see [Chapter 5, "Working with Decision Tables"](#).

You use ruleflow, that is the ruleset stack, to order rulesets. For information on working with the ruleset stack, see *Rules Language Reference for Oracle Business Process Management*.

## C.12 Why do XML Schema with xsd:string Typed Elements Import as Type JAXBElement?

According to the JAXB 2.0 spec, the default type mapping for elements that have `minOccurs="0"` and `nillable="true"` is `JAXBElement<T>`, where `T` is the default mapping of the type defined for the element. For example, `xsd:string` maps to `JAXBElement<String>`, `xsd:int` maps to `JAXBElement<Integer>`, and `xsd:integer` maps to `JAXBElement<BigInteger>`. This is because `nillable="true"` means the user has defined a semantic difference between an element not being defined in a document, with `minOccurs=0`, it does not have to be defined, and an element being defined but having the attribute `nil="true"`. This is a subtle difference and is often used to define the difference between an unknown value and a value known to be "no value".

To use the `JAXBElement`-typed property in a rule, the property must be first checked for non-null, and then the "value" property or `getValue()` method can be used retrieve a value of the underlying type:

```
fact FactType1 &&
    FactType1.prop1 != null &&
    FactType1.prop1.value == "abc"
```

Alternatively, you may want to define a customized JAXB binding so nillable elements are mapped to type `T` rather than `JAXBElement<T>`. However, this is a lossy conversion, as you no longer are able to determine the difference between a non-existent element and a nil one. This does make the nillable attribute less useful, but it does allow you to explicitly define an element as nil in your document, similarly to how in Java an Object-typed field is initialized to null by default or you can explicitly initialize it to null.

There are several ways to do this. In both cases, add these attributes to the top-level `xsd:schema` element start tag:

```
xmlns:jaxb="http://java.sun.com/xml/ns/jaxb"
jaxb:version="2.0"
```

1. To specify ALL properties to use the binding, add this immediately inside the `xsd:schema` opening tag:

```
<xsd:annotation>
  <xsd:appinfo>
    <jaxb:globalBindings generateElementProperty="false" />
  </xsd:appinfo>
</xsd:annotation>
```

2. To specify only specific properties use the binding, add an annotation like this to each desired element:

```
<xsd:element name="stringElement2" type="xsd:string" minOccurs="0"
nillable="true">
  <xsd:annotation>
    <xsd:appinfo>
      <jaxb:property generateElementProperty="false" />
    </xsd:appinfo>
  </xsd:annotation>
</xsd:element>
```

3. Add the definitions to an external customizations file and pass it as an argument when adding the schema to the datamodel. This can only be done when programmatically calling the `SchemaBrowser` class and is not exposed in Rule Designer.

## C.13 Why Are Changes to My Java Classes Not Reflected in the Data Model?

Do not import classes that have been compiled into the "SCA-INF/classes" directory. Classes in this directory cannot be reloaded into the datamodel when they change.

## C.14 How Do I Use Rules SDK to Include a null in an Expression?

You can use the following Rules SDK code to include a null value:

```
SimpleTest test = pattern.getSimpleTestTable().add();
test.getLeft().setValue(attr);
test.setOperator(Util.TESTOP_NE);
test.getRight().setValue("null");
```

## C.15 Is WebDAV Supported as a Repository to Store a Dictionary?

The Web Distributed Authoring and Versioning (WebDAV) repository is not supported to store a dictionary in Oracle Fusion Middleware 11g Release 1 (11.1.1) Oracle Business Rules. Oracle Business Rules supports using an MDS (file backed or Database backed) repository for storing dictionaries.

## C.16 Using a Source Code Control System with Rules Designer

There are special considerations when you use Rules Designer and a source control system, such as CVS or Subversion. When you use a source code control system with Rules Designer you need to specify that rule dictionary files in your project are recognized as "binary" files instead of "text" files. The rule dictionary files are XML documents and by default the source code control system treats these files as text files. However, rule dictionary files cannot be merged because the files contain semantic structure. If a rule dictionary file is treated as a text file and then changed, the source control system attempts to merge the file with a "trivial" merge. Using a trivial merge creates a semantically invalid dictionary file which cannot be unmarshalled into a `RuleDictionary` object.

Thus, when you use a source code control system with rule dictionary files, rules files, you need to make sure the source code control system treats the files as binary files. There are configuration options you need to set to specify that the system treats dictionary files as binary files. For example, in the Subversion source code control system you can set the MIME type with the `svn:mime-type` file property. For more information, see

<http://svnbook.red-bean.com/nightly/en/svn.advanced.props.file-portability.html#svn.advanced.props.special.mime-type>

When you set the source code control system options to specify the binary file type, this allows the source code control system, for example `tortoiseSVN`, to treat the rules dictionary files correctly, as binary files.



---

# Oracle Business Rules Troubleshooting

This appendix contains workarounds and solutions for issues you may encounter when using Oracle Business Rules.

The following topics are covered:

- [Section D.1, "Getter and Setter Methods are not Visible"](#)
- [Section D.2, "Java Class with Only a Property Setter"](#)
- [Section D.3, "Runtime NoClassDefFound Error"](#)
- [Section D.4, "RL Specific Keyword Naming Conflict Errors"](#)
- [Section D.5, "java.lang.IllegalAccessError from Business Rules Service Runtime"](#)
- [Section D.6, "JAXB 1.0 Dictionaries and RL MultipleInheritanceException"](#)
- [Section D.7, "Why Does XML Schema with Underscores Fail JAXB Compilation?"](#)
- [Section D.8, "How Are Decision Service Input Output Element Types Restricted?"](#)
- [Section D.9, "How Are Decision Service Input Output Schema Restricted?"](#)
- [Section D.10, "How Do I Handle Java Reserved Names in an Imported Fact Type?"](#)

## D.1 Getter and Setter Methods are not Visible

Rules Designer does not list the methods supporting a Java bean property in choice lists; only the bean properties are visible. For example, a Java bean with a property named `Y` must have at least a getter method `getY()` and may also have a setter method `setY(y-type-param)`. All of properties and methods (including getter and setter that compose the properties) are displayed when viewing the Java FactType. Only the properties of Java Classes (not the getter and setter methods) are displayed in choice lists. When attempting to control the visibility of the property it is best to use the properties visibility flag. Marking a getter or a setter method as not visible may not remove the properties from choice lists.

## D.2 Java Class with Only a Property Setter

In Java the Java Bean introspector includes write-only properties. Oracle RL does not include such properties as Beans, because they cannot be reasoned on in a rule. Thus, in order for Java fact type bean properties to be properly accessed in Oracle RL they must have both a getter and setter. Properties which have a setter but not a getter, that is write-only properties, are not allowed in the Oracle RL "new" syntax.

For example, if a bean `Foo` only has the method `setProp1(int i)`, then you cannot use the following in Oracle RL:

```
Foo f = new Foo(prop1: 0)
```

### D.3 Runtime NoClassDefFound Error

Sometimes when working with XML facts, you might receive an error of the form:

```
Exception in thread "main" java.lang.NoClassDefFoundError:
```

The `java.lang.NoClassDefFoundError` is very likely due to required classes not in classpath. Try checking the following:

- Add `xml.jar` to your classpath when executing.
- Add the directory where the generated and compiled JAXB classes are placed to the classpath.

### D.4 RL Specific Keyword Naming Conflict Errors

Oracle Business Rules escapes RL specific keywords when generating RL from Rules Designer. In most cases, RL specific keywords can be used without causing errors. One exception is using a keyword as the name of a class. This is unlikely for Java classes because by convention they start with an upper case letter and RL specific keywords are all lowercase. For more information, see *Rules Language Reference for Oracle Business Process Management*.

### D.5 `java.lang.IllegalAccessError` from Business Rules Service Runtime

Problem: I receive an error such as the following:

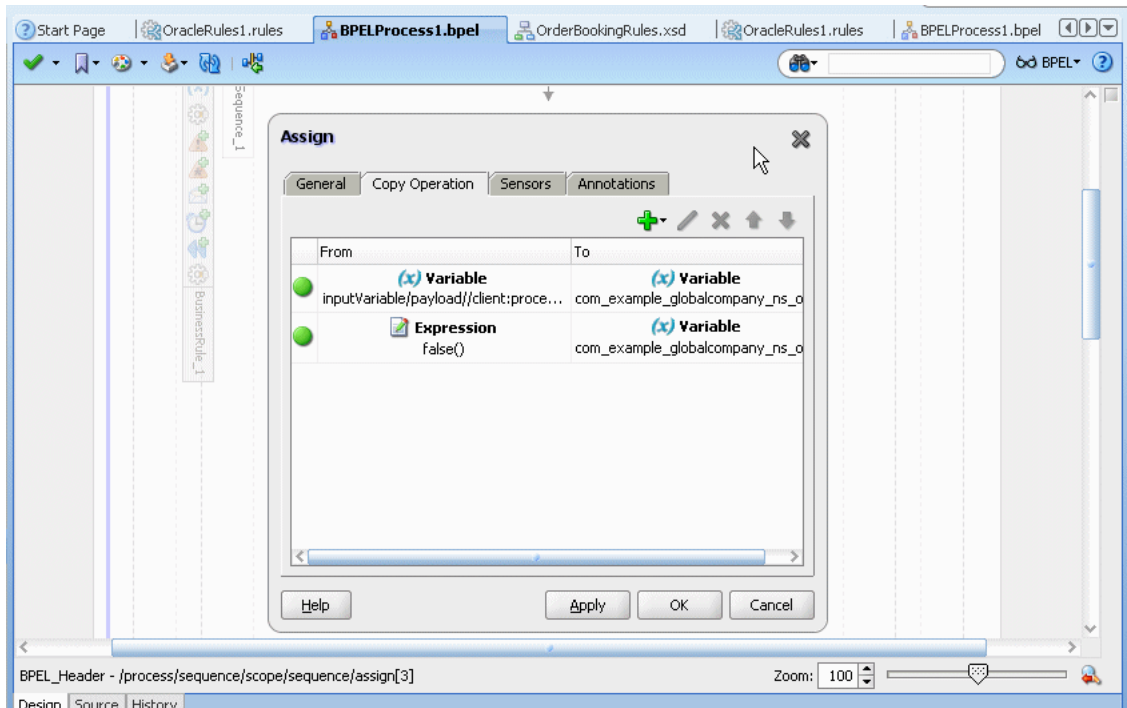
```
java.lang.IllegalAccessError: tried to access class  
com.sun.xml.bind.v2.runtime.reflect.opt.Const from class:...
```

Reason: This can be due to JAXB 2.1.6 issue 490, caused when unmarshalling incorrect, for example letter characters when float is expected, data as described at the following site,

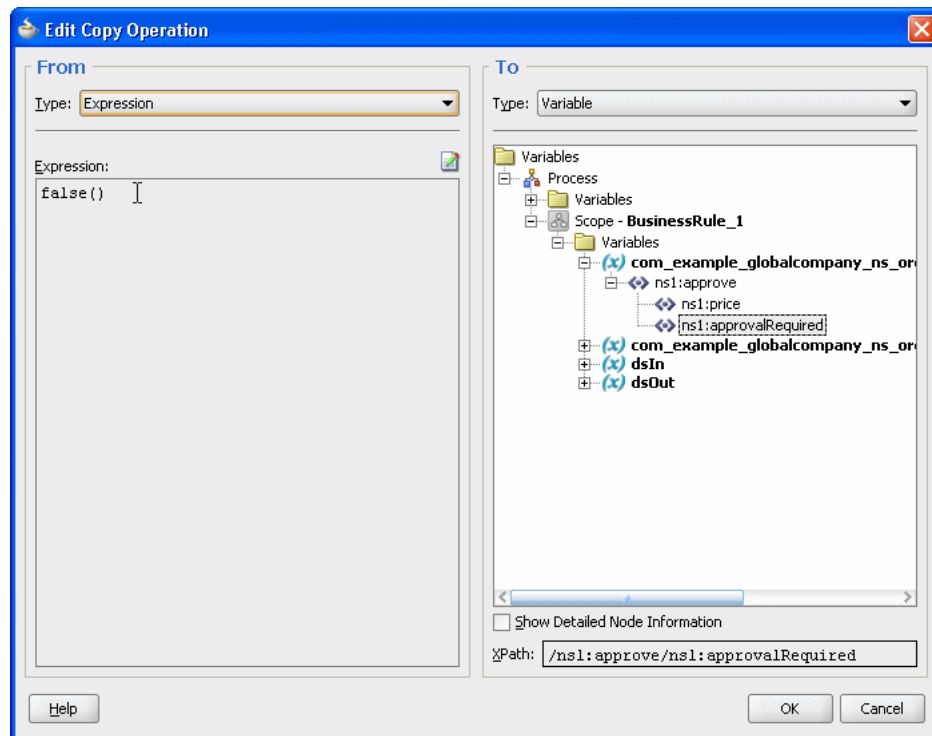
<http://java.net/jira/browse/JAXB-490>

Workaround: the workaround for this problem is to assign a value to the appropriate element, as shown in [Figure D-1](#) and [Figure D-2](#) where `approvalRequired` is assigned a default value `false()`.

**Figure D-1 Adding an Expression to Initialize a Value for a Business Rules Service Input**



**Figure D-2 Expression Assigned to Input Variable for Business Rules Service**



## D.6 JAXB 1.0 Dictionaries and RL MultipleInheritanceException

Dictionaries which have been migrated from 10.1.3 use JAXB 1.0 instead of JAXB 2.0, which is the default for Oracle Fusion Middleware 11g Release 1 (11.1.1) dictionaries. Because of this use of JAXB 1.0, the migrated dictionaries may contain Element types. If your dictionary has Element types marked as visible, generated RL may throw `MultipleInheritanceException`.

The solution to this issue is to mark the Element fact types non-visible or remove them from the datamodel. Only the Type classes generated by JAXB should be used to write rules, so there is no functionality loss from deleting the Element types.

## D.7 Why Does XML Schema with Underscores Fail JAXB Compilation?

The defined behavior of JAXB is to fail when a name of the form '\_' + number is found. In this case JAXB cannot generate an "obvious" Java class name from this string. The default behavior of JAXB for '\_' + char is to treat it as a word boundary (`underscoreBinding="asWordSeparator"`), which means the underscore is stripped and the char is `UpperCamelCased`. For example, `_fooBar` is mapped to `FooBar`.

To fix this problem, you need to provide a schema customization to direct JAXB to generate the names differently. The default value for `underscoreBinding` is specified as `"asWordSeparator"`, which does not allow an underscore to be used at the beginning of a name.

The global annotation `underscoreBinding="asCharInWord"` causes the '\_' to be preserved in the classname and `UpperCamelCase` after the number:

```
<xsd:annotation><xsd:appinfo>
    <jaxb:globalBindings underscoreBinding="asCharInWord" />
</xsd:appinfo></xsd:annotation>
```

With this global annotation, the mapping for `_1foo_bar_baz` is `_1Foo_Bar_Baz`.

## D.8 How Are Decision Service Input Output Element Types Restricted?

Using the Decision Service to run business rules with XML schema defining the input, for any given `complexType "tFoo"` in an XML-Schema file `Foo.xsd` there can only be one XML-Schema element "foo" of type "tFoo". The Decision Service does not allow you to use two elements "foo" and "bar" of the same type "tFoo".

## D.9 How Are Decision Service Input Output Schema Restricted?

When you use the Decision Service a schema must define a `complexType` or import another schema which defines a `complexType`. You cannot use schemas which do not define `complexType`, such as the following:

```
<xsd:schema xmlns:xsd="http://www.w3.org/2001/XMLSchema"
    xmlns="http://www.example.org"
    targetNamespace="http://www.example.org"
    elementFormDefault="qualified">
    <xsd:element name="count" type="xsd:int"/>
</xsd:schema>
```

## D.10 How Do I Handle Java Reserved Names in an Imported Fact Type?

In Oracle Business Rules, when you import fact type properties which would have the same name as a Java language reserved word are excluded. For a complete list of Java reserved words, see

[http://java.sun.com/docs/books/tutorial/java/nutsandbolts/\\_keywords.html](http://java.sun.com/docs/books/tutorial/java/nutsandbolts/_keywords.html)

A workaround is to rename the getter and setter method pair that produce the excluded property. If these methods names cannot be changed, the methods should be used in rules instead of the properties.

For example, if a property named `continue` is excluded, you can create rules that use `getContinue()` and `setContinue()` methods instead of using the property.

You can do this by rewriting a pattern. For example, replace:

```
fact IncrCount ic && ic.continue == "foo"
```

with:

```
fact IncrCount ic && ic.getContinue() == "foo"
```

For another example, in an action, replace:

```
[assert new] IncrCount(continue:"bar")
```

with:

```
[assign new] IncrCount ic = new IncrCount( )  
[call] ic.setContinue("bar")  
[assert] ic
```



---

---

# Working with Oracle Business Rules and JSR-94 Execution Sets

This appendix describes the Java Rule Engine API (JSR-94) specification that defines a standard Java runtime API to access a rule engine from a Java SE or Java EE client.

The appendix includes the following sections:

- [Section E.1, "Introduction to Oracle Business Rules and JSR-94 Execution Sets"](#)
- [Section E.2, "Creating JSR-94 Rule Execution Sets from Oracle Business Rules Rulesets"](#)
- [Section E.3, "Using the JSR-94 Interface with Oracle Business Rules"](#)

For more information, see:

- <http://jcp.org/en/jsr/detail?id=94>
- <http://java.sun.com/developer/technicalArticles/J2SE/JavaRule.html>

## E.1 Introduction to Oracle Business Rules and JSR-94 Execution Sets

Oracle Business Rules provides JSR-94 support. This allows you to create more portable rule-enabled applications.

You can create JSR-94 execution sets from Oracle Business Rules rulesets and you can create JSR-94 rule sessions from these execution sets. For more information, see [Section E.2, "Creating JSR-94 Rule Execution Sets from Oracle Business Rules Rulesets"](#).

You can access Oracle Business Rules rulesets and execute them against the Oracle Business Rules Engine using the JSR-94 API. For more information, see [Section E.3, "Using the JSR-94 Interface with Oracle Business Rules"](#).

Oracle Business Rules also provides extensions to the JSR-94 API that you may find useful. For more information, see [Section E.3.4, "Using Oracle Business Rules JSR-94 Extensions"](#).

## E.2 Creating JSR-94 Rule Execution Sets from Oracle Business Rules Rulesets

To use JSR-94 with rules in RL Language text, you must map the rules to a JSR-94 rule execution set.

A JSR-94 rule execution set (rule execution set) is a collection of rules that are intended to be executed together. You also must register a rule execution set before running it. A

registration associates a rule execution set with a URI; using the URI, you can create a JSR-94 rule session.

---



---

**Note:** In Oracle Business Rules, a JSR-94 rule execution set registration is not persistent. Thus, you must register a rule execution set programmatically using a JSR-94 `RuleExecutionSetProvider` interface.

---



---

For more information, see [Section E.3.1, "Creating a Rule Execution Set with `createRuleExecutionSet`"](#).

## E.2.1 Creating Rule Execution Set with Oracle Business Rules RL Language Text

You can use JSR-94 with RL Language rulesets saved as text, where the Oracle RL text is directly included in the rule execution set. For more information, see ["Using the Extended `createRuleExecutionSet` to Create a Rule Execution Set"](#) on page E-6 for information about JSR-94 extensions that assist you in including RL Language text.

**To create a rule execution set from Oracle Business Rules Oracle RL language text:**

1. Specify the RL Language mapping information in an XML document. [Table E-1](#) shows the mapping elements required to construct a rule execution set. [Example E-1](#) shows a sample XML document for mapping RL Language text to a JSR-94 rule execution set.
2. You then use the XML document with the JSR-94 administration APIs to create a rule execution set. The resulting rule execution set is registered with a JSR-94 runtime (using a `RuleAdministration` instance).

**Table E-1 Oracle Business Rules Oracle RL Language Text XML Mapping Elements for JSR-94**

Element	Description
<code>&lt;rule-source&gt;</code>	Includes an <code>&lt;rl-text&gt;</code> tag containing explicit RL Language text containing an Oracle Business Rules ruleset. Multiple <code>&lt;rule-source&gt;</code> tags can be used to specify multiple rulesets (specified in the order in which they are interpreted).
<code>&lt;ruleset-stack&gt;</code>	Specifies a list of rulesets that form the initial ruleset stack. The order of the rulesets in the list is from the top of the stack to the bottom of the stack.

---



---

**Note:** In the `<rl-text>` element the contents must escape XML predefined entities. This includes the characters '&', '>', '<', '"', and '\\'.  


---



---

**Example E-1 XML Mapping File for Rulesets Defined in an Oracle RL Program**

```
<rule-execution-set xmlns="http://xmlns.oracle.com/rules/jsr94/configuration"
xmlns:xsi="http://www.w3.org/2001/XMLSchema-instance" version="1.0">
  <name>CarRentalDemo</name>
  <description>The Car Rental Demo</description>
  <rule-source>
    <rl-text>
      ruleset DM {
        fact class carrental.Driver {
          hide property ableToDrive, driverLicNum, licIssueDate, licenceType,
```



```

        licIssueDate, numPreAccidents, numPreConvictions,
        numYearsSinceLicIssued, vehicleType;
    };

    final String DeclineMessage = "Rental declined ";

    public class Decision supports xpath {
        public String driverName;
        public String type;
        public String message;
    }

    function assertXPath(String package,
                        java.lang.Object element, String xpath) {
        //RL literal statement
        main.assertXPath( package, element, xpath );
    }

    function println(String message) {
        //RL literal statement
        main.println(message);
    }

    function showDecision(DM.Decision decision) {
        //RL literal statement
        DM.println( "Rental decision is " + decision.type +
                    " for driver " + decision.driverName +
                    " for reason " + decision.message);
    }
}
</rl-text>
</rule-source>
<rule-source>
<rl-text>
    ruleset vehicleRent {
        rule UnderAge {
            priority = 0;
            if ((fact carrental.Driver v0_Driver &&
                (v0_Driver.age < 19))) {
                DM.println( "Rental declined: " + v0_Driver.name +
                    " Under age, age is: " + v0_Driver.age);
                retract(v0_Driver);
            }
        }
    }
</rl-text>
</rule-source>
<ruleset-stack>
    <ruleset-name>vehicleRent</ruleset-name>
</ruleset-stack>
</rule-execution-set>

```

## E.2.2 Creating a Rule Execution Set from Oracle RL Text Specified in a URL

You can use JSR-94 with Oracle RL rulesets specified using a URL. For more information, see ["Using the Extended createRuleExecutionSet to Create a Rule Execution Set"](#) on page E-6 for information about JSR-94 extensions that assist you in specifying a URL.

### To create a rule execution set from Oracle RL text specified in a URL:

1. Specify the Oracle RL mapping information in an XML document. [Table E-2](#) shows the mapping elements required to construct a rule execution set. [Example E-2](#) shows a sample XML document for mapping Oracle RL text to a

JSR-94 rule execution set.

2. You then use the XML document with the JSR-94 administration APIs to create a rule execution set. The resulting rule execution set is registered with a JSR-94 runtime (using a `RuleAdministration` instance).

**Table E-2 Oracle Business Rules Oracle RL URL XML Mapping Elements for JSR-94**

Element	Description
<code>&lt;rule-source&gt;</code>	Includes an <code>&lt;rl-url&gt;</code> tag containing a URL that specifies the location of RL Language text. Multiple <code>&lt;rule-source&gt;</code> tags can be used to specify multiple rulesets (in the order in which they are interpreted).
<code>&lt;ruleset-stack&gt;</code>	Specifies a list of rulesets that form the initial ruleset stack. The order of the rulesets in the list is from the top of the stack to the bottom of the stack.

**Example E-2 XMP Mapping File for Rulesets Defined in a URL**

```
<?xml version="1.0" encoding="UTF-8"?>
<rule-execution-set xmlns="http://xmlns.oracle.com/rules/jsr94/configuration"
  xmlns:xsi="http://www.w3.org/2001/XMLSchema-instance" version="1.0">
  <name>CarRentalDemo</name>
  <description>The Car Rental Demo</description>
  <rule-source>
    <rl-url>
      file:rl/DM.r1
    </rl-url>
  </rule-source>
  <rule-source>
    <rl-url>
      file:rl/VehicleRent.r1
    </rl-url>
  </rule-source>
  <ruleset-stack>
    <ruleset-name>vehicleRent</ruleset-name>
  </ruleset-stack>
</rule-execution-set>
```

### E.2.3 Creating Rule Execution Sets with Rulesets from Multiple Sources

A rule execution set may contain rules that are derived from multiple sources and the sources may be a mix of Rules Designer defined rulesets and RL Language rulesets. In this case, the XML element `<rule-execution-set>` set contains multiple `<rule-source>` elements, one for each source of rules. You must list each `<rule-source>` in the order in which they are to be interpreted in Rules Engine.

---

**Note:** For this Oracle Business Rules release, a JSR-94 rule execution set can only reference one Rules Designer dictionary.

---

## E.3 Using the JSR-94 Interface with Oracle Business Rules

This section describes some Oracle Business Rules specific details for JSR-94 interfaces.

### E.3.1 Creating a Rule Execution Set with `createRuleExecutionSet`

The `RuleExecutionSetProvider` and `LocalRuleExecutionSetProvider` interfaces in `javax.rules.admin` include the `createRuleExecutionSet` to create a `RuleExecutionSet` object.

For the remaining `createRuleExecutionSet` methods, the first argument is interpreted as shown in [Table E-3](#).

**Table E-3** First Argument Types for `createRuleExecutionSet` Method

Argument	Description
<code>org.w3c.dom.Element</code>	Specifies an instance of the <code>&lt;rule-execution-set&gt;</code> element from the configuration schema.
<code>java.lang.String</code>	Specifies a URL that specifies the location of an XML document that is an instance of the <code>&lt;rule-execution-set&gt;</code> element from the configuration schema.
<code>java.io.InputStream</code>	Specifies an input stream that is used to read an XML document that is an instance of the <code>&lt;rule-execution-set&gt;</code> element from the configuration schema.
<code>java.io.Reader</code>	Specifies a character reader that is used to read an XML document that is an instance of the <code>&lt;rule-execution-set&gt;</code> element from the configuration schema.

---

**Note:** JSR-94 also includes `createRuleExecutionSet` methods that take a `java.lang.Object` argument, which is intended to be an abstract syntax tree for the rule execution set. In Oracle Business Rules for Oracle Fusion Middleware 11g Release 1 (11.1.1), using these methods with this argument is not supported. Invoking these methods with a `java.lang.Object` argument gives a `RuleExecutionSetCreateException` exception.

---

The second argument to the `createRuleExecutionSet` methods is a `java.util.Map` of vendor-specific properties.

### E.3.2 Creating a Rule Session with `createRuleSession`

Clients create a JSR-94 rule session using the `createRuleSession` method in the `RuleRuntime` class. This method takes a `java.util.Map` argument of vendor-specific properties. This argument can be used to pass in any of the properties defined for the Oracle Business Rules `oracle.rules.rl.RuleSession`. If a rule execution set contains URL or repository rule sources, the rules from those sources are fetched on the creation of each new `RuleSession`.

### E.3.3 Working with JSR-94 Metadata

JSR-94 allows for metadata for rule execution sets and rules within a rule execution set. The Oracle Business Rules implementation does not add any additional metadata beyond what is in the JSR-94 specification. The rule execution set description is an optional item and thus may not be present. If it is not present, the empty string is returned. For rules, only the rule name is available and the description is initialized with an empty string.

## E.3.4 Using Oracle Business Rules JSR-94 Extensions

This section covers the following extensions provided in the JSR-94 implementation classes.

- [Using the Extended createRuleExecutionSet to Create a Rule Execution Set](#)
- [Invoking an RL Language Function in JSR-94](#)

### E.3.4.1 Using the Extended createRuleExecutionSet to Create a Rule Execution Set

Oracle Business Rules provides a helper function to facilitate creating the XML control file required as input to create a RuleExecutionSet.

The helper method `createRuleExecutionSet` is available in the `RLLocalRuleExecutionSetProvider` class. The `createRuleExecutionSet` method has the following signature:

```
RuleExecutionSet createRuleExecutionSet(String name,
                                       String description,
                                       RuleSource[] sources,
                                       String[] rulesetStack,
                                       Map properties)
```

[Table E-4](#) describes the `createRuleExecutionSet` arguments.

**Table E-4** *createRuleExecutionSet Arguments*

Argument	Description
<code>name</code>	Specifies the name of the rule execution set.
<code>description</code>	Specifies the description of the rule execution set.
<code>sources</code>	Specifies an array of specifications for the sources of rules. The <code>RuleSource</code> is an interface that the following classes implement: <ul style="list-style-type: none"> <li>■ <code>RLTextSource</code>: RL Language text for RL Language text.</li> <li>■ <code>RLUrlSource</code>: RL Language URL for a URL to RL Language text.</li> </ul> For more information, see the <code>oracle.rules.jsr94.admin</code> package in <i>Oracle Fusion Middleware Java API Reference for Oracle Business Rules</i> .
<code>rulesetstack</code>	Specifies the initial contents of the RL Language ruleset stack to be set before each time the rules are executed. The contents of the array should be ordered from the top of stack (0th element) to the bottom of stack (last element).
<code>properties</code>	Oracle specific properties.

### E.3.4.2 Invoking an RL Language Function in JSR-94

In a stateful interaction with a JSR-94 rule session, a user may want the ability to invoke an arbitrary RL Language function. The class that implements the JSR-94 `StatefulRuleSession` interface provides access to the `callFunction` methods in the `oracle.rules.rl.RuleSession` class.

[Example E-3](#) shows how you can to invoke an RL Language function with no arguments in a JSR-94 `StatefulRuleSession`.

#### **Example E-3** *Using CallFunction with a StatefulRuleSession*

```
import javax.rules.*;
...
StatefulRuleSession session;
...
((oracle.rules.jsr94.RLStatefulRuleSession) session).callFunction("myFunction");
```

---

---

## Working with Rule Reporter

This appendix describes how to use the Rule reporter API to create lists or reports of the contents of a rules dictionary.

The appendix includes the following sections:

- [Section F.1, "Introduction to Working with Rule Reporter"](#)
- [Section F.2, "Using Rule Reporter Command Line Interface"](#)
- [Section F.3, "Using Rule Reporter with Java"](#)

### F.1 Introduction to Working with Rule Reporter

As the size and complexity of an Oracle Business Rules dictionary grows, documenting the dictionary and communicating with others about the contents of the rules dictionary can be important. Using the `RuleReporter` class you can create lists or reports of the contents of a rules dictionary. You can use these reports to document your design and to communicate about the dictionary contents.

There are two ways to use Rule Reporter:

- Execute `RuleReporter` on the command line
- Create custom reports using the `RuleReporter` API in a Java program

Rule Reporter is written in the Groovy programming language using the `MarkupBuilder` class, making it easy to create custom reporters whether you simply want to have differently formatted HTML or use an entirely different markup language. Groovy is a Java-like dynamic language which runs on the JVM and interacts seamlessly with Java objects.

#### F.1.1 What You Need to Know About Rule Reporter HTML Style Sheets

The `JDEV_INSTALL/jdeveloper/soa/modules/oracle.rules_11.1.1/reporter.jar` file contains style sheet `oracle/rules/tools/reporter/style.css`. When you place this file in the same directory as the HTML output file that Rule Reporter generates, this provides definitions to render the page. You can modify the style sheet to change the HTML layout.

#### F.1.2 What You Need to Know About RuleReporter API

For complete details on the `RuleReporter` API, see the *Oracle Fusion Middleware Java API Reference for Oracle Business Rules*.

### F.1.3 What You Need to Know About Rule Reporter Dependent Jar Files

The command-line or Java API use of Rule Reporter needs to have the classpath include all required JAR files.

## F.2 Using Rule Reporter Command Line Interface

You can execute a command line script to use Rule Report to list the contents of a dictionary.

### F.2.1 How to List the Contents of a Dictionary with Rule Reporter Command Line

You can execute a command line script to use Rule Report to list the contents of a dictionary.

**To list the contents of a dictionary with Rule Reporter using the command line:**

1. Open a terminal shell window on your system.
2. Update your classpath to include RuleReporter dependencies as [Example F-1](#) shows.

For more information, see [Section F.1.3, "What You Need to Know About Rule Reporter Dependent Jar Files"](#).

3. Run RuleReporter with the following command line as [Example F-1](#) shows:

```
java oracle.rules.tools.reporter.RuleReporter DICT-NAME DEST-FILE
LINK-PATHS
```

Where:

- *DICT-NAME*: the name of the rules dictionary you want to generate a report on.

For example:

```
C:\JDeveloper\mywork\GradeApp\Grades\oracle\rules\grades\OracleRules1.rules.
```

- *DEST-FILE*: the name of the destination file for the generated Rule Reporter output, usually suffixed with `.html`.

For example: `C:\Temp\report.html`.

- *LINK-PATHS*: a list of the locations on the file system which may contain dictionaries that *DICT-NAME* links to.

For example: `C:\Temp`.

If *DICT-NAME* does not link to any dictionaries, you must still specify at least one path.

[Example F-1](#) shows how to generate a report for a dictionary.

#### **Example F-1 Executing RuleReporter on the Command Line**

```
C:\> set CLASSPATH=%CLASSPATH%;C:\Oracle\Middleware\jdeveloper\modules\oracle.adf.model_11.1.1\adfm.jar;C:\Oracle\Middleware\jdeveloper\modules\oracle.adf.model_11.1.1\groovy-all-1.5.4.jar;C:\Oracle\Middleware\wlserver_10.3\server\lib\ojdbc6.jar;C:\Oracle\Middleware\jdeveloper\soa\modules\oracle.rules_11.1.1\rules.jar;C:\Oracle\Middleware\jdeveloper\modules\oracle.xdk_11.1.1\xmlparserv2.jar
```

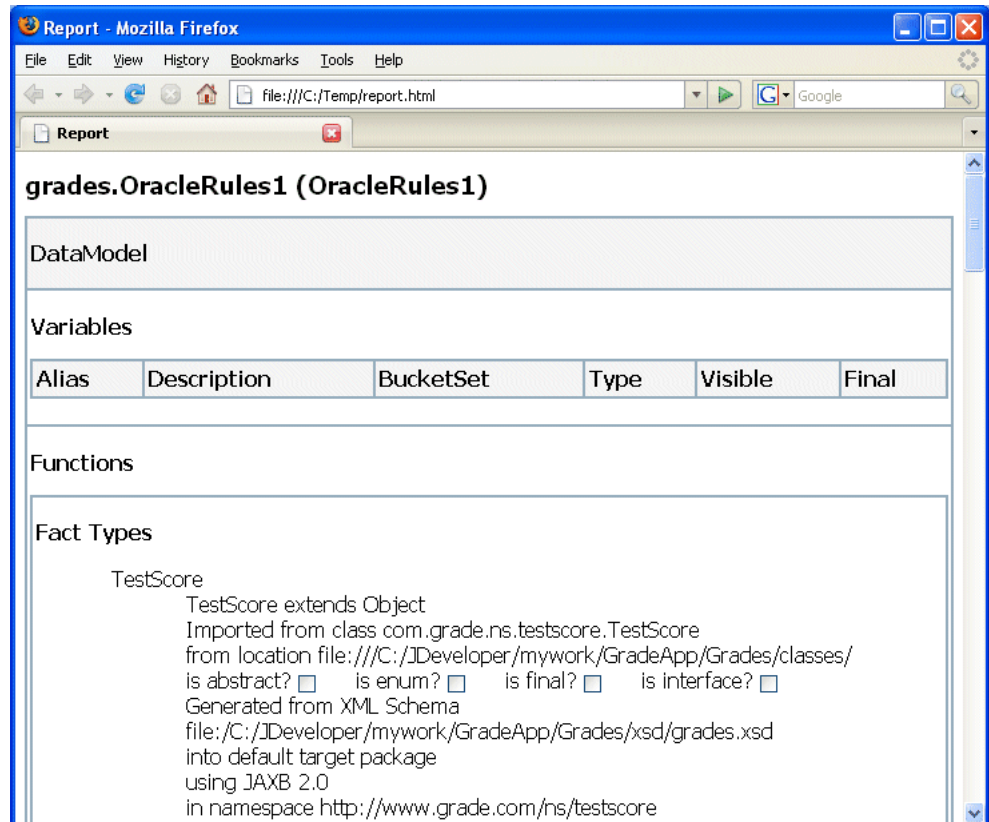
```
C:\> java oracle.rules.tools.reporter.RuleReporter
C:\JDeveloper\mywork\GradeApp\Grades\oracle\rules\grades\OracleRules1.rules
C:\Temp\report.html C:\Temp
```

- Optionally, copy the `JDEV_INSTALL/jdeveloper/soa/modules/oracle.rules_11.1.1\reporter.jar` file oracle/rules/tools/reporter/style.css

to the same directory as the HTML output file. In this example, copy the `style.css` file to `C:/Temp`.

This causes a web browser to use the definitions to render the page. You can modify the style sheet to change the visual layout of the HTML as shown in [Figure F-1](#).

**Figure F-1** RuleReporter report.html with style.css



## F.3 Using Rule Reporter with Java

You can quickly and easily create a basic report of the contents of a dictionary using a Java application with the `oracle.rules.tools.reporter.RuleReporter` class.

### F.3.1 How to List the Contents of a Dictionary Using Rule Reporter with Java

You can use the `RuleReporter` class to list the contents of a dictionary. This class, `oracle.rules.tools.reporter.RuleReporter` takes several arguments, as shown:

```

RuleReporter ruleReporter = new RuleReporter(
    DICT-NAME,
    DEST-FILE,
    LINK-PATHS
);

```

Where:

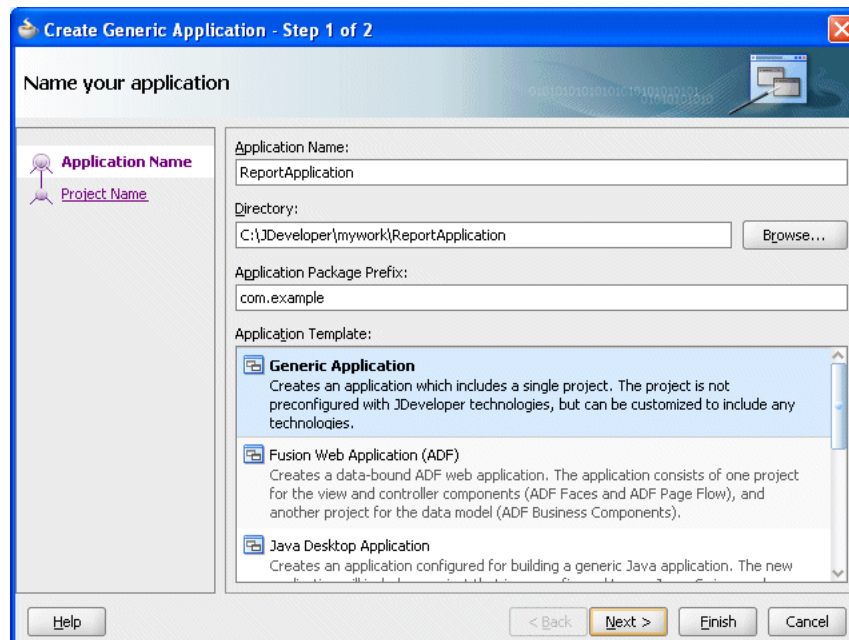
- *DICT-NAME*: the name of the rules dictionary you want to generate a report on.  
For example:  
C:\JDeveloper\mywork\GradeApp\Grades\oracle\rules\grades\OracleRules1.rules.
- *DEST-FILE*: the name of the destination file for the generated Rule Reporter output, usually suffixed with .html.  
For example: C:\Temp\report.html.
- *LINK-PATHS*: a list of the locations on the file system which may contain dictionaries that *DICT-NAME* links to.  
For example: `new ArrayList<String>(Arrays.asList("C:\Temp"))`.  
If *DICT-NAME* does not link to any dictionaries, you must still specify at least one path.

When you supply these arguments and call the `RuleReporter.report()` method, this produces a dictionary report for the specified dictionary.

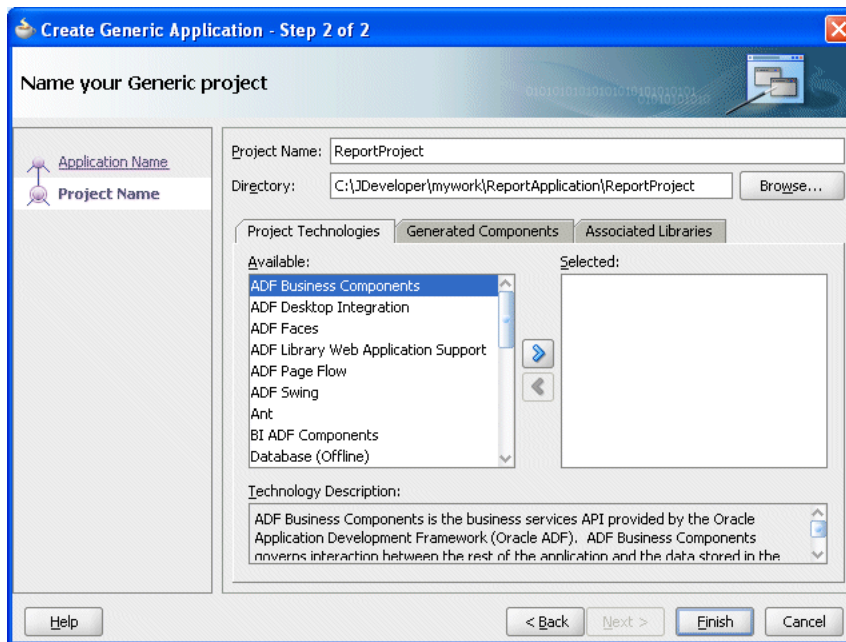
**To list the contents of a dictionary using rule reporter with Java:**

1. Start Oracle JDeveloper, this displays the Oracle JDeveloper start page.
2. In the Application Navigator, click **New Application** if no applications have been created, or if applications have been created, click **Applications** and from the list choose **New Application**.
3. In the Create Application wizard, enter the name and location for the application:
  - a. In the **Application Name** field, enter an application name. For example, enter `ReportApplication`.
  - b. Enter or browse for a directory name, or accept the default.
  - c. Enter an application package prefix or accept the default, no prefix.  
  
This should be a globally unique prefix and commonly uses a domain name owned by your company. The prefix, followed by a period, applies to objects created in the initial project of an application.  
  
In this sample, you use the prefix `com.example`.
  - d. For this Oracle Business Rules project, select **Generic Application** for the application template, as shown in [Figure F-2](#).

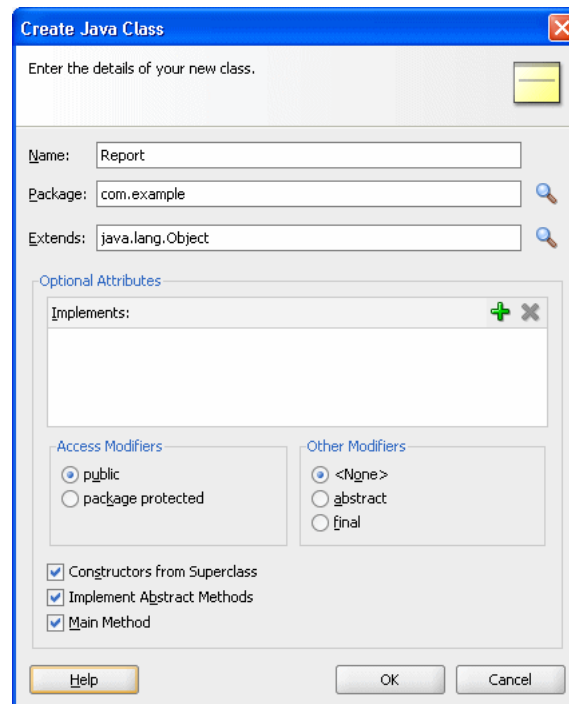


**Figure F–2 Adding the Report Application**

4. Click **Next**.
5. In the Create Generic Application wizard - Name your Generic project page, enter the name and location for the project as shown in [Figure F–3](#):
  - In the **Project Name** field, enter an application name. For example, enter ReportProject.
  - Enter or browse for a directory name, or accept the default.
  - On the Project Technologies tab, in the Available list, select **Java** and click **Add** to add it to the Selected area.

**Figure F–3 Specifying Technologies in a Project**

6. Click **Finish**.
7. In Oracle JDeveloper, select the project named **ReportProject**.
8. Right-click and from the list select **Project Properties**.
9. Select the **Libraries and Classpath** item.
10. Add the libraries **Adfm Designtime API**, **JAXB**, **ADF Model Runtime**, **Oracle XML Parser v2**, **Oracle JDBC**, and **Oracle Rules**.
11. Click **OK**.
12. In Oracle JDeveloper, select the project named **ReportProject**.
13. Right-click and from the list select **New**.
14. In the New Gallery, in the **Categories** area, select **General**.
15. In the New Gallery, in the **Items** area, select **Java Class**.
16. Click **OK**.
17. In the Create Java Class window, configure the following properties as shown in [Figure F–4](#):
  - Enter the **Name** value **Report**.
  - Check the following check boxes:
    - **Public**
    - **Main Method**

**Figure F–4** Creating the Report.java Class

18. Click **OK**.

Oracle JDeveloper displays the Java Class, as shown in [Example F–2](#).

#### **Example F–2** Code Created for New Report.java Class

```
package com.example;

public class Report {
    public static void main(String[] args) {
        Report report = new Report();
    }
}
```

19. Use the RuleReporter class as shown in [Example F–3](#). Replace the first argument to the RuleReporter constructor with the location of your dictionary.

#### **Example F–3** Report.java Completed

```
package com.example;

import java.util.List;
import java.util.Arrays;
import java.util.ArrayList;

import oracle.rules.sdk2.exception.SDKException;
import oracle.rules.tools.reporter.RuleReporter;

public class Report {
    public Report() throws SDKException {
        try {

            RuleReporter ruleReporter = new RuleReporter(
                "C:\\JDeveloper\\mywork\\GradeApp\\Grades\\oracle\\rules\\grades\\OracleRules1.rules",
                "C:\\Temp\\report.html",
                Arrays.asList("C:\\Temp")
            );
        }
    }
}
```

```

    );

    ruleReporter.report();

} catch (Exception e) {
    System.out.println(e);
}
}

public static void main(String[] args) throws SDKException {
    Report report = new Report();
}
}

```

20. In the Application Navigator, right-click `ReportProject` and select **Make**.

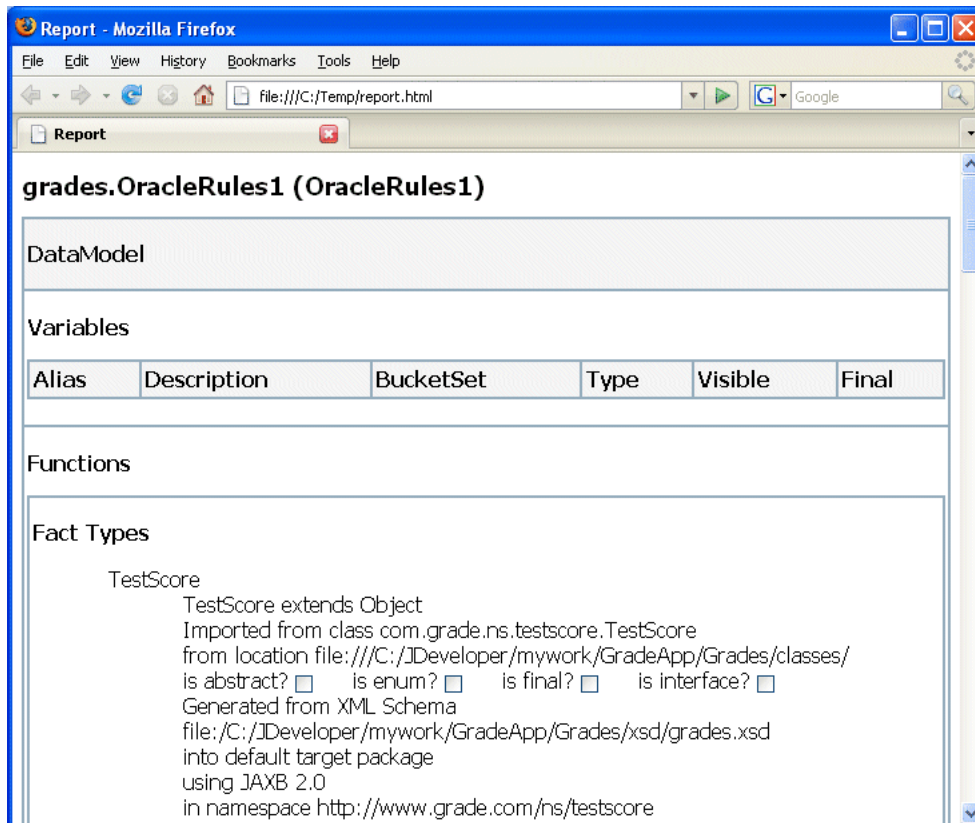
21. In the Application Navigator, right-click `Report.java` and select **Run**.

In this example, the `Report.java` class generates the report in  
`C:\Temp\report.html`

22. Optionally, copy the `JDEV_INSTALL/jdeveloper/soa/modules/oracle.rules_11.1.1\reporter.jar` file `oracle/rules/tools/reporter/style.css` style sheet to the same directory as the HTML output file. In this example, copy the `style.css` file to `C:/Temp`.

This causes a web browser to use the definitions to render the page. You can modify the style sheet to change the visual layout of the HTML as shown in [Figure F-5](#).

**Figure F-5** *RuleReporter report.html with style.css*



## A

---

### actions

- advanced, 4-37
  - area, 5-4
  - cell, 5-4
  - decision table, 5-4
  - definition, 4-19
  - do nothing value, 5-7
  - fact type, 10-3
- active option, 4-28
- ADF Business Components Fact
- action fact type, 10-3
  - creating, 10-9
  - definition, 10-1
  - importing, 3-16
  - key\_values, 3-18, 10-2
  - types, 3-15
- ADF Business Components Fact ViewRowImpl, 3-15
- advanced actions, 4-37
- advanced mode, 4-27
- advanced settings, 4-25
- aggregates
- average, 4-38
  - collection, 4-38
  - count, 4-38
  - maximum, 4-38
  - minimum, 4-38
  - sum, 4-38
- aliases, A-1
- allow gaps option, 5-18, 5-24
- auto override conflict resolution
- setting option, 5-25
- average aggregate, 4-38

## B

---

- batch invocation, 10-7
- BigDecimal type, 3-8
- BigInteger type, 3-8
- BPEL
- decision functions, 6-6
  - Human Tasks, 11-2
  - java.lang.IllegalAccessError, D-2
  - service component, 11-2
- bucketsets

- adding Enum type, 3-23
  - adding list of ranges (Range), 3-21
  - adding list of values (LOV), 3-19
  - allowed in actions field, 3-29
  - associating with facts, 3-30
  - creating, 3-18
  - definition, 1-4, 3-2
  - duplicate bucket value, 3-28
  - global, 3-18
  - Include Disallowed Buckets in Tests field, 3-29
  - list of values (LOV) adding, 3-19
  - local, 3-18
- built-in dictionary
- Java wrappers, 3-8
- business rules
- activity, 6-6
  - decision function, 6-6
  - definition, 1-1
  - deployment and runtime, 9-23
  - dictionary, 1-5
  - in a Java EE application, 9-1
  - RL Language, 1-6

## C

---

- calendar type
- with CurrentDate fact, 4-56
- check rule flow option, 6-2
- classpath
- Java facts, 3-8
  - Rule Reporter, F-2
- collection aggregate, 4-38
- combined dictionary, 2-2, 12-16
- com.sun.xml.bind.v2.runtime.reflect.opt.Const
- errors, D-2
- Condition Browser, 12-38, 12-43
- condition expressions
- cell, 5-3
  - definition, 5-3
- conflict analysis, 5-19, 12-56
- decision table, 5-24
- conflict policy option, 5-19, 12-56
- conflict resolution, 5-19, 12-56
- constant option for globals, 2-11
- count aggregate, 4-38
- CurrentDate fact, 4-56

## D

---

- data model
  - definition, 2-1
  - sharing, 2-8
- data types
  - bucketset, 1-3
  - fact properties, 1-3
- Date Browser, 12-39
- dates
  - reasoning with CurrentDate fact, 4-56
- decision functions, 6-1, 6-5
  - adding, 6-1
  - adding to a dictionary, 6-1
  - as decision service, 11-4
  - BPEL, 6-6
  - Business Rule activity, 6-6
  - calling with Java decision point interface, 10-7
  - check rule flow option, 6-2
  - definition, 1-4
  - rule firing limit option, 6-6
  - stateless option, 6-3
  - understanding, 6-1
  - Web service, 6-1, 6-2
- decision point API
  - batch invocation, 10-7
  - definition, 1-4
  - production dictionary, 7-15
  - rules SDK, 7-1
  - runtime properties, 10-5
  - transaction, 10-5
  - with MDS repository, 7-15
- decision service
  - decision function, 11-4
- decision table
  - action cell, 5-4
    - do nothing value, 5-7
  - actions, advanced, 4-37
  - active option, 4-28
  - adding a rule, 5-12
  - adding actions, 5-10
  - adding condition expressions, 5-9
  - advanced mode, 4-27
  - advanced settings, 4-25
  - aggregates, 4-38
  - allow gaps option, 5-18, 5-24
  - auto override conflict resolution, 5-25
  - cell values, 5-7
  - condition expression, 5-3
  - condition expression cell, 5-3
  - conflict analysis, 5-19, 5-24, 12-56
  - conflict policy option, 5-19, 12-56
  - conflict resolution, 5-19, 12-56
  - creating, 5-8
  - decision tree, 5-5
  - definition, 1-4
  - do not care values, 5-7
  - effective dates, 4-30
  - expression builder, 4-60
  - find gaps, 5-18, 5-24
  - gap analysis, 5-18, 5-24
  - logical option, 4-28
  - move operation, 5-16
  - priority, 4-29
  - rules, 5-5
  - show conflicts, 5-19, 12-56
  - sibling cell, 5-14
  - understanding, 5-1
  - validation, 4-24
- decision tree, 5-5
- DecisionPoint class, 7-2
- DecisionPointBuilder class, 7-2
- DecisionPointInstance class, 7-2
- .decs file, 11-3
- deployment
  - EAR file, 9-31
  - MAR file, 9-28
- dictionary
  - combined, 2-2, 12-16
  - data model sharing, 2-8
  - decision function, 6-1, 6-5
  - definition, 1-5, 2-1
  - globals, 2-10
  - link, 12-16
  - naming conventions, 2-9, A-1
  - package, 2-8
  - reading
    - UTF-8 character encoding, 7-11
  - validation, 4-22, 4-23, 4-25
  - viewing and editing settings, 2-6
- dictionary links
  - updating, 2-8
- do nothing value, 5-7
- Double type, 3-8
- duplicate bucket values, 3-28

## E

---

- EAR file, 9-31
- effective dates, 4-2, 4-30
- expression
  - constant, 2-11
- Expression Builder, 12-37, 12-43
- expression builder
  - about, 4-60

## F

---

- fact type
  - ADF Business Components, 3-15
  - Java, 3-8
  - RL, 3-12
  - XML, 3-3
- facts
  - and working memory, 1-9
  - associating with bucketsets, 3-30
  - definition, 1-4, 3-2
- FileInputStream
  - UTF-8, 7-11
- filtering rules, 4-3
- final option for globals, 2-11

Float type, 3-8  
forward-chaining system, 1-8  
frequently asked questions, C-1  
functions  
    decision, 6-5  
    oracle business rules, 2-12  
    testing, 8-1

---

## G

gap analysis, 5-18, 5-24  
global bucketset, 3-18  
globals  
    constant option, 2-11  
    defined, 2-10  
    final option, 2-11

---

## H

Human Tasks, 11-2

---

## I

importing XML schema, 3-7  
Include Disallowed Buckets in Tests option, 3-29  
inference cycle, 1-8  
Integer type, 3-8

---

## J

Java EE application  
    with business rules, 9-1  
Java Fact  
    adding, 3-8  
    getter method visibility, D-1  
    setter method visibility, D-1  
    types, 3-8  
    using a Property Change Listener with, C-5  
`java.lang.IllegalAccessException`, D-2  
`java.lang.NoClassDefFoundError`, D-2  
JAXB  
    generated classes, 3-3  
    issue 490 troubleshooting, D-2  
    limitations with XML facts, 3-7  
    with XML facts, 3-2  
JSR-94  
    definition, E-1  
    extensions, E-6  
    rule execution set, E-1  
    with RL Language text, E-2  
    with URL, E-3

---

## K

`key_values`, 3-18, 10-2

---

## L

links  
    dictionary, 12-16  
    to a dictionary in the same application, 2-6

list tests, 4-43  
local bucketset, 3-18  
logical option, 4-28  
Long type, 3-8

---

## M

MAR file, 9-28  
matched fact naming, 4-34  
maximum aggregate, 4-38  
metadata  
    .decs file, 11-3  
    EAR file, 9-31  
    MAR file, 9-28  
    service component, 11-1, 11-3  
minimum aggregate, 4-38  
move operation, 5-16

---

## N

named priority, 4-29  
naming conventions  
    alias, A-1  
    dictionary, 2-9, A-1  
    matched fact, 4-34  
    RL Language keywords, D-2  
    Rule Designer, A-1  
    rulesets, A-1  
    XML schema target package name, A-1  
nested tests, 4-30  
numeric priority, 4-29

---

## O

Oracle Business Rules Function, 2-12  
    testing, 8-1  
Oracle Business Rules function  
    creating, 2-13  
Oracle Business Rules RL Language. *See* RL Language  
Oracle Business Rules Rules Engine. *See* Rules Engine  
Oracle Business Rules SDK2. *See* SDK  
Oracle Business Rules service component. *See* service component

---

## P

pattern binding variable, 4-34  
pattern matching, 4-32  
priority  
    default, 4-29  
    definition, 4-29  
    high, 4-29  
    higher, 4-29  
    highest, 4-29  
    integer value, 4-29  
    low, 4-29  
    lower, 4-29  
    lowest, 4-29  
    medium, 4-29  
    named, 4-29  
    numeric, 4-29

- order, C-8
- Property Change Listener, C-5
- prototyping
  - rules, 3-12

## R

---

- range tests, 4-13
- reload XML facts from updated schemas, 3-7
- Rete algorithm, 1-9
- Right Operand Browser, 12-39
- RL Fact
  - adding, 3-13
  - types, 3-12
- RL Language
  - definition, 1-6
  - self-join, C-3
- rule language. *See* RL Language
- Rule Reporter
  - classpath, command line, F-2
  - command line, F-2
- RuleDictionary
  - UTF-8 character encoding, 7-11
- rules
  - actions, 1-3, 4-19
  - active option, 4-28
  - adding actions, 4-19
  - advanced mode, 4-27
    - actions, 4-37
    - aggregates, 4-38
    - matched fact naming, 4-34
    - pattern matching, 4-32
    - setting, 4-42
    - simple tree mode, 4-46
    - tree mode, 4-43
  - advanced settings, 4-25
  - aggregate, 4-32
  - conflicts, C-8
  - creating, 4-8
  - data driven, 1-8
  - definition, 1-1, 4-1
  - effective dates, 4-30
  - engine, 1-5
  - expression builder, 4-60
  - filtering, 4-3
  - firing, 1-8
  - for each case where, 4-32
  - forward-chaining, 1-8
  - generating reports with SDK, F-1
  - list tests, 4-43
  - logical option, 4-28
  - nested tests, 4-30
  - pattern binding variable, 4-34
  - pattern block, 4-33
  - priority, 4-29, C-8
  - prototyping, 3-12
  - range tests, 4-13
  - reporter, F-1
  - rule actions, 1-2
  - rule conditions, 1-2, 1-3

- SDK, 1-6
- service component, 11-1
- set tests, 4-16
- testing, 8-1
- tests, 4-9
- there is a case where, 4-32
- there is no case where, 4-32
- tree mode, 4-43
- validation, 4-23
- Rules Designer
  - introduction, 1-7
  - rule actions, 1-3
  - rule conditions, 1-3
  - rules, 1-2
  - service component metadata, 11-2
  - WSDL, 11-2
- Rules Engine
  - architecture, 1-8
  - definition, 1-5
- rules paging, 12-36
- rules SDK
  - decision point API, 7-1
  - definition, 1-6
- rulesets
  - creating, 4-2
  - definition, 1-4, 4-1
  - effective dates, 4-2
  - filtering, 4-3
  - naming, A-1

## S

---

- SDK
  - definition, 1-6
  - generating reports, F-1
  - rule reporter, F-1
- self-join in Oracle RL, C-3
- service component
  - BPEL, 11-2
  - definition, 1-5, 11-1
  - Human Tasks, 11-2
  - metadata, 11-1, 11-3
  - rules, 11-1
  - SOA composite application integration, 11-2
  - standalone component, 11-2
  - Web service, 11-1
- set tests, 4-16
- Short type, 3-8
- simple tree mode, 4-46
- SOA Composer
  - adding rule actions, 12-28
  - adding rule conditions, 12-25
  - adding rules, 12-22
  - Bookmarkable Link, 12-6
  - Browser windows
    - Condition Browser, 12-38, 12-43
    - Date Browser, 12-39
    - Expression Builder, 12-37, 12-43
    - Right Operand browser, 12-39
  - browser windows, 12-37



- commit menu, 12-63
- conflict resolution, 12-56
- decision tables, 12-40
  - adding actions, 12-44
  - adding condition rows, 12-41
  - adding decision tables, 12-40
  - adding rules, 12-45
  - compacting table, 12-54
  - deleting decision tables, 12-59
  - gap analysis, 12-54
  - splitting and compacting, 12-53
  - splitting table, 12-53
  - switching rows to columns, 12-57
- deleting rule actions, 12-29
- deleting rule conditions, 12-27
- deleting rules, 12-24
- dictionary path, 12-7
- edit menu, 12-12
- editing bucketsets, 12-13, 12-14
  - editing a range bucketset, 12-14
  - editing an LOV bucketset, 12-15
- editing decision functions, 12-18
- editing rules, 12-21
- linked dictionaries, 12-16
- modifying rule actions, 12-30
- modifying rule conditions, 12-27
- My Edits option, 12-6
- obtaining composite and dictionary information, 12-69
- open menu, 12-4
- rules advanced settings, 12-24
- rules paging, 12-36
- synchronizing rules dictionary, 12-64
- tree mode rules, 12-35
- updating the validation panel, 12-69
- validating rules dictionary, 12-65
  - validation panel, 12-66
- validation panel, 12-66
  - updating the validation panel, 12-69
- viewing bucketsets, 12-8
- viewing globals, 12-7
- viewing rulesets, 12-10
- SOA Designer role
  - SOA Composer
    - authentication and SOA Designer role, 12-3
- stateless option
  - decision functions, 6-3
- sum aggregate, 4-38

## T

---

- testing
  - rules, 8-1
  - with a test function, 8-1
- tests
  - in rules, 4-9
  - list, 4-43
  - range, 4-13
  - set, 4-16
- transactions, 10-5

- tree mode
  - creating tree mode rules, 4-48
  - simple, 4-46
  - with decision tables, 4-43
  - with rules, 4-43
- troubleshooting, D-1
  - getter method visibility, D-1
  - java.lang.IllegalAccessException, D-2
  - java.lang.NoClassDefFoundError, D-2
  - setter method visibility, D-1

## U

---

- Unicode characters, 7-11
- updated XML schema with XML facts, 3-7
- UTF-8 characters, 7-11

## V

---

- validation
  - data model, 4-23
  - decision table, 4-24
  - dictionaries, 4-22, 4-23, 4-25
  - rules, 4-23
- variable, 4-34
- visibility
  - getter methods, D-1
  - setter methods, D-1

## W

---

- Web service
  - decision function, and, 6-1, 6-2
  - service component, 11-1
  - WSDL, 11-1, 11-2
- WebDAV repository support, C-9
- working memory, 1-9
- WSDL
  - Rules Designer, 11-2
  - service component metadata, 11-1

## X

---

- XML Fact
  - adding, 3-3
  - java.lang.NoClassDefFoundError, D-2
  - JAXB-generated classes, 3-3
  - reload XML facts from updated schemas, 3-7
  - support XPath assertion, 3-6
  - XPath, 3-6
- XPath, 4-47
  - RL program, E-3
  - support assertion, 3-6
  - XML Fact, 3-6

